







Assembly Tools

Production Fastening and Drilling







Contents

Electric Fastening Tools

-  **6**
Electric Screwdrivers
-  **18**
DC Electric Nutrunners
-  **30**
DC Electric Fixtured Spindles
-  **36**
Fixtured Fastening Systems
-  **39**
DC Electric Controllers
-  **42**
ICS Software
-  **49**
Calibration Equipment





Air Fastening Tools

-  **55**
Pistol Grip Screwdrivers
-  **78**
Inline Screwdrivers
-  **94**
Angle Air Nutrunners
-  **115**
Inline Air Nutrunners
-  **125**
Pulse Tools



Air Production Drills

-  **140**
Pistol Grip Drills
-  **154**
Inline Drills
-  **161**
Angle Drills
-  **169**
Modular Drills





Other Air Tools

-  **172**
Air Tappers
-  **174**
Air Riveters
-  **175**
Electro Dressers



Accessories

-  **177**
Spring Balancers
-  **180**
Torque Reaction Arms & Holders
-  **182**
Workstations
-  **183**
Spindle Accessories
-  **186**
Other Accessories



Model Identification Guide ... 187

Reference Guides 191





































Index 195

Technical Symbols

For ease of use, specification tables frequently use symbols in column headings. Please reference the chart below for exact descriptions.

 Fixtured fastening systems	 Straight drills	 Torque range with heavy clutch spring	 Square drive or bit holder
 Voltage	 Angle fastening tools	 1 min. Max. free speed	 Spindle thread
 Spindle accessories	 Angle drills	 Bolt capacity	 Square drive or bit holder
 Drilling	 Fixtured fastening tools	 Max. Nm Stall torque	 Floating spindle stroke
 Tapping	 1234 Nm Torque control system	 Max. Max chuck/collet capacity or bit holder	 Rivet set shank diameter
 Riveting	 Reversible models	 1 min. Blows per minute	 Tool length
 Spring balancers	 Non-reversible models	 Tool weight	 Tool length
 Pistol grip fastening tools	 Torque range	 Max. air consumption	 Tool length
 Pistol grip drills	 Torque range with light clutch spring	 Piston stroke	 Tool length
 Straight fastening tools	 Torque range with medium clutch spring	 Bit holder or Square drive	 Tool length

Technical Symbols (Cont.)

	Tool length		Angle head height		Sound level		ICS software
	Tool length		Angle head height		Tool air inlet connection		Calibration equipment
	Tool length		Nominal load capacity		Hose min. internal diameter		Electrode dressers
	Side-to-center distance		Standard height of lift		Rated power		Working stations
	Side-to-center distance		1/4" hex quick change		Spindle length		Other accessories
	Side-to-center distance		1/4" hex bit holder		Spindle length		Torque reaction arms & holders
	Side-to-center distance		1/4" hex insert bit holder		Size		Parts manual
	Side-to-center distance		1/4" hex bit holder (requires bit guide or finder)		Number of tools controlled		Product information manual
	Side-to-center distance		Square drive		Bore		Maintenance information manual
							Operation and maintenance manual

Electric Fastening Tools

Ingersoll Rand's full line of Electric Fastening Tools delivers the ultimate combination of accuracy, durability, and ergonomics to maximize your assembly line's productivity. The World-Class QE & QM Series of handheld and fixtured DC electric tools, coupled with ICD & M Controllers and Software, offer state of the art closed-loop transducerized control for your most critical applications. For other applications, our high quality family of mechanical clutch electric screwdrivers offers an economical alternative to closed-loop control. Regardless of the complexity of your requirements, you can trust Ingersoll Rand to deliver the right solution to meet your needs.



6
Electric Screwdrivers



18
DC Electric Nutrunners



30
DC Electric Fixtured Spindles

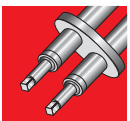

36
Fixtured Fastening Systems



39
DC Electric Controllers



42
ICS Software



49
Calibration Equipment



Electric Screwdriver

Torque Selection Guide

DC Screwdrivers	Model	0	0.25 Nm	0.50 Nm	0.75 Nm	1.00 Nm	1.25 Nm	1.50 Nm	Referral page
		▼	▼	▼	▼	▼	▼	▼	
	ELM0110N		█						7
	EL0109B		█						9
	ELM0107N		█						7
	ELM0306N			█					7
	EL0410BC-SS-ESD			█					8
	EL0510BC-SS-ESD			█					8
	EL0410B		█	█					9
	ES45T		█	█	█				10
	EL0807BC-SS-ESD			█	█	█			8
	ES50T		█	█	█	█			10
	EL1007BC-ESD			█	█	█	█		8
	EL1007B		█	█	█	█	█		9

AC Screwdrivers	Model	0	0.5 Nm	1.0 Nm	1.5 Nm	2.0 Nm	2.5 Nm	3.0 Nm	3.5 Nm	4.0 Nm	4.5 Nm	Referral page
		▼	▼	▼	▼	▼	▼	▼	▼	▼	▼	
	EP1520N			█	█							12
	EP1510N			█	█							12
	ES90P			█	█	█						13
	ES60P			█	█	█						13
	ES80P				█	█	█					13
	EP2612N				█	█	█					12
	EP2607N				█	█	█					12
	EP2603N				█	█	█					12
	ES70P				█	█	█					13
	EPB2612N			█	█	█	█					11
	EPB2620N			█	█	█	█					11
	ET4007N					█	█	█	█			12
	ES100T					█	█	█	█			13

Angle Head Screwdrivers	Model	0	1.0 Nm	2.0 Nm	3.0 Nm	4.0 Nm	5.0 Nm	6.0 Nm	7.0 Nm	Referral page
		▼	▼	▼	▼	▼	▼	▼	▼	
	ES90T1S5		█							15
	EL1510N1S5		█							14
	ES90T2S3		█	█						15
	EL1510N2S3		█	█						14
	ES60T2S3		█	█						15
	EL2612N1S5			█	█					14
	ES70T1S5		█	█						15
	ES70T2S3		█	█	█					15
	EL2612N2S3			█	█	█				14
	ES100T2S3			█	█	█	█			15
	ET4007N2S3				█	█	█			14

Electric Screwdrivers

Inline

Micro Electric Screwdrivers

ESD protection in an ergonomic space-saving package.

Features

- Torque Range: 0.18 – 3.5 in-lbs (0.02 – 0.40 Nm)
- Speeds: 600 – 1,000 rpm
- 24 V DC from controller (ECM24N)
- Electro-static discharge (ESD) models offer added protection for sensitive electronic assembly applications
- Extremely lightweight and compact ergonomic design
- Variable speed and soft-start features built into controller
- Detachable 1.5 m cable, hanger bail, and two bits included
- Recommended for low-torque applications requiring additional ESD protection along with precise torque and speed control

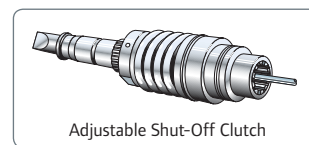

Service and Accessories

Manuals:

45549169

45549144

45549177

Controller Manuals:

45549193

45549185

45549201

Accessories:

Balancer, see page 177
Shaker box, see page 16
Bits, see page 17

Model	V	in-lbs (Nm)	in-lbs (Nm)	rpm	lb (kg)	in (mm)	in (mm)	Controller Required
DC INLINE LEVER START								
ELM0107N	24 V DC	0.18 – 0.62 (0.02 – 0.07)	0.35 – 1.77 (0.04 – 0.20)	750	0.51 (0.23)	6.52" (165.5)	0.16" (4.0)	ECM24N
ELM0110N	24 V DC	0.18 – 0.62 (0.02 – 0.07)	0.35 – 1.77 (0.04 – 0.20)	1,000	0.51 (0.23)	6.52" (165.5)	0.16" (4.0)	ECM24N
ELM0306N	24 V DC	1.33 – 3.54 (0.15 – 0.40)	–	600	0.51 (0.23)	6.52" (165.5)	0.16" (4.0)	ECM24N

Model	Input Voltage	Output Voltage	lb (kg)	in (mm)	Soft Start	Speed Adjust	ESD Control
CONTROLLER							
ECM24N	115 V AC	24 V DC	1.98 (0.90)	5.9" x 3.6" x 2.1" (150 x 91 x 52)	YES	YES	YES

Electric Screwdrivers

Inline

Low-Torque Versatec ESD

ESD protection in an award-winning ergonomic package.

Features

- Torque Range: 1.7 – 10.4 in-lbs (0.19 – 1.2 Nm)
- Speeds: 500 – 1,000 rpm
- 24 V DC from ESD controller (EC24N-ESD)
- Electro-static discharge (ESD) models offer added protection for sensitive electronic assembly applications
- Variable speed and soft-start features built into controller
- Lightweight, compact design
- Clean room-rated
- Vacuum pickup ready
- Soft stop models minimize failures to sensitive equipment by limiting the motor inertia as the clutch begins to shut off
- Recommended for low-torque applications requiring additional ESD protection along with precise torque and speed control



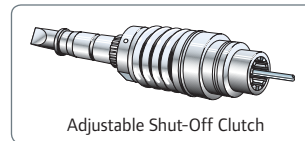

EL1007B





Adjustable Shut-Off Clutch

Service and Accessories

Manuals:







-  16574683
-  16578692
-  16575367



Controller Manuals:

-  45532066
-  45532041
-  45532058

Accessories:

- Balancer, see page 177
- Shaker box, see page 16
- Bits, see page 17

						Controller Required	
Model	V	in-lbs (Nm)	rpm	lb (kg)	in (mm)	in (mm)	
DC LEVER START ESD ONLY MODEL							
EL1007BC-ESD	24 V DC	1.7 – 10.4 (0.19 - 1.2)	500 – 700	0.77 (0.35)	10.5" (267)	1/4" 	EC24N-ESD
DC LEVER START SOFT STOP ESD MODELS							
EL0410BC-SS-ESD	24 V DC	1.7 – 3.5 (0.2 – 0.4)	700 – 1000	0.88 (0.4)	10.5" (267)	0.16" (4.0)	EC24N-ESD
EL0510BC-SS-ESD	24 V DC	2.2 – 4.8 (0.2 – 0.5)	700 – 1000	0.88 (0.4)	10.5" (267)	0.16" (4.0)	EC24N-ESD
EL0807BC-SS-ESD	24 V DC	3.9 – 8.2 (0.4 – 0.9)	500 – 700	0.88 (0.4)	10.5" (267)	0.16" (4.0)	EC24N-ESD
EL1007BC-SS-ESD	24 V DC	4.8 – 10.4 (0.5 – 1.2)	700 – 1000	0.88 (0.4)	10.5" (267)	0.16" (4.0)	EC24N-ESD

			Soft Start	Speed Adjust	ESD Control
Model	Input Voltage	Output Voltage	lb (kg)	in (mm)	
CONTROLLER					
EC24N-ESD	115 V AC	24 V DC	5.1 (2.31)	10.5" x 3.3" x 4.1" (267 x 83 x 104)	YES YES YES

Low-Torque Versatec

Sets the standards for ergonomics and operator convenience.

Features

- Torque Range: 0.26 – 10.4 in-lbs (0.03 – 1.2 Nm)
- Speeds: 500 – 1,000 rpm
- 24 V DC from controller (EC24N)
- Ergonomic package features contoured soft-touch grip, two-finger lever actuation, and easy forward reverse control providing the ultimate in operator comfort and productivity
- Variable speed and soft-start features built into controller
- Lightweight, compact design
- Externally adjustable torque control
- Clean room models available without soft-touch grip
- Two bits, 1.5 m cable, and hanger bail included
- Recommended for low-torque applications requiring precise torque and speed control

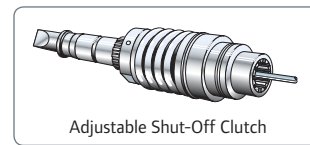

Service and Accessories

Manuals:

- 45530128
- 45527595
- 45530136

Controller Manuals:

- 45532066
- 45532041
- 45532058

Accessories:

- Balancer, see page 177
- Shaker box, see page 16
- Bits, see page 17

							Controller Required
Model	V	in-lbs (Nm)	rpm	lb (kg)	in (mm)	in (mm)	
INLINE LEVER START							
EL0109B	24 V DC	0.26 – 1.30 (0.03 – 0.15)	650 – 950	0.7 (0.32)	9.25" (235)	0.16" (4.06)	EC24N
EL0410B	24 V DC	0.44 – 4.79 (0.05 – 0.54)	750 – 1000	0.8 (0.32)	9.25" (235)	0.25" (6.35)	EC24N
EL1007B*	24 V DC	0.5 – 10.44 (0.06 – 1.2)	500 – 700	0.8 (0.32)	9.25" (235)	0.25" (6.35)	EC24N
INLINE LEVER START CLEAN ROOM							
EL0410BC	24 V DC	0.44 – 4.79 (0.05 – 0.54)	750 – 1000	0.8 (0.32)	9.25" (235)	0.25" (6.35)	EC24N
EL1007BC*	24 V DC	0.5 – 10.44 (0.06 – 1.2)	500 – 700	0.8 (0.32)	9.25" (235)	0.25" (6.35)	EC24N

*Two clutch springs are furnished to cover torque range. Tool is shipped with heavier clutch spring installed.

				Soft Start	Speed Adjust	ESD Control	
Model	Input Voltage	Output Voltage	lb (kg)				
CONTROLLER							
EC24N	115 V AC	24 V DC	5.1 (2.31)	10.5" x 3.3" x 4.1" (267 x 83 x 104)	YES	YES	NO

Electric Screwdrivers

Inline

Low-Torque ES Series



Proven performance in an economical package.

Features



- Torque Range: 0.4 – 9.0 in-lbs (0.05 – 1.0 Nm)
- Speeds: 500 – 900 rpm
- 24 V DC from controller (ESCB50)
- Precise torque control for more efficient and accurate production
- Variable speed and soft-start features built into controller
- Externally adjustable torque control
- Clean room models available
- Two bits, 1.5 m cable, and hanger bail included
- Recommended for low-torque applications requiring precise torque and speed control

Service and Accessories

Manuals:

-  45527777
-  45527702
-  45527801







Controller Manuals:



-  45532090
-  45532074
-  45532082

Accessories:

- Balancer, see page 177
- Shaker box, see page 16
- Bits, see page 17



								Controller Required
Model	V	in-lbs (Nm)	in-lbs (Nm)	rpm	lb (kg)	in (mm)	in (mm)	
DC INLINE LEVER START								
ES45T	24 V DC	0.5 – 4.7 (0.06 – 0.53)	1.7 – 6.0 (0.19 – 0.68)	600 – 900	0.75 (0.34)	8.87" (225)	0.25" (6.35)	ESCB50
ES50T	24 V DC	0.4 – 4.7 (0.05 – 0.53)	2.0 – 9.0 (0.23 – 1.02)	500 – 650	0.75 (0.34)	8.88" (226)	0.25" (6.35)	ESCB50
DC INLINE CLEAN ROOM LEVER START								
ES50TC	24 V DC	0.4 – 4.7 (0.05 – 0.53)	2.0 – 9.0 (0.23 – 1.02)	500 – 650	0.88 (0.40)	10.50" (267)	0.25" (6.35)	ESCB50

				Soft Start	Speed Adjust
Model	Input Voltage	Output Voltage	lb (kg)	in (mm)	
CONTROLLER					
ESCB50	115 V AC	24 V DC	4.4 (1.9)	6.8" x 5.8" x 4.3" (171 x 146 x 108)	YES YES

High-Torque Brushless

Brushless design provides accuracy and increased durability.

Features

- Torque Range: 3.5 – 26.5 in-lbs (0.4 – 3.0 Nm)
- Speeds: 1,200 – 2,000 rpm
- 115 V AC plug in with integral 3 m cable
- Excellent accuracy and durability resulting from improved clutch and brushless motor design
- Wide torque range allows expanded application coverage from a single tool
- Ergonomic soft-touch grip improves operator comfort
- RoHS-compliant
- Bit, hanger bail, and low-torque spring included
- Recommended for higher duty cycle applications where precise torque control is required

Service and Accessories

Manuals:

-  45549128
-  45549110
-  45549136

Accessories:

- Balancer, see page 177
- Shaker box, see page 16
- Bits, see page 17
- Pistol grip handle: DLW2100TP



Model	V	in-lbs (Nm)	in-lbs (Nm)	rpm	lb (kg)	in (mm)	in (mm)
DC INLINE PUSH-TO-START							
EPB2612N	115 V AC	3.54 – 14.16 (0.4 – 1.6)	10.62 – 26.55 (1.2 – 3.0)	1,200	1.54 (0.7)	10.9" (276)	0.25" (6.4)
EPB2620N	115 V AC	3.54 – 14.16 (0.4 – 1.6)	10.62 – 26.55 (1.2 – 3.0)	2,000	1.54 (0.7)	10.9" (276)	0.25" (6.4)
DC INLINE LEVER START							
ELB2612N	115 V AC	3.54 – 14.16 (0.4 – 1.6)	10.62 – 26.55 (1.2 – 3.0)	1,200	1.54 (0.7)	10.8" (274)	0.25" (6.4)
ELB2620N	115 V AC	3.54 – 14.16 (0.4 – 1.6)	10.62 – 26.55 (1.2 – 3.0)	2,000	1.54 (0.7)	10.8" (274)	0.25" (6.4)

Electric Screwdrivers

Inline / Pistol

High-Torque Versatec



Sets the standards for ergonomics and operator convenience.

Features

- Torque Range: 5.0 – 40.0 in-lbs (0.6 – 4.5 Nm)
- Speeds: 300 – 2,000 rpm
- 115 V AC plug in with detachable 8 foot cable
- Ergonomic package features contoured soft-touch grip, two-finger lever actuation, and easy forward reverse control providing the ultimate in operator comfort and productivity
- Removable contoured flange and torque adjustment cover protects torque setting while giving instant visible confirmation in readout window
- Brush replacement light signals when maintenance is required
- Dual position cord allows 90 degree connector rotation for optimal cable routing
- Two bits, two brushes, and hanger bail included
- Recommended for applications where precise torque control is required

Service and Accessories

Manuals:

-  45530102
-  45527579
-  45530110

Accessories:







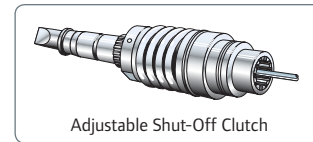











- Balancer, see page 177
- Shaker box, see page 16
- Bits, see page 17
- Pistol grip handle; EP4007N-48
- Torque adjusting wrench, see page 16



EP4007N



Adjustable Shut-Off Clutch

						
Model	V	in-lbs (Nm)	rpm	lb (kg)	in (mm)	in (mm)
DC INLINE PUSH-TO-START						
EP1520N	115 V AC	5.0 – 15.0 (0.6 – 1.7)	2,000	1.6 (0.73)	11.25" (286)	0.25" (6.35) 
EP1510N	115 V AC	5.0 – 15.0 (0.6 – 1.7)	1,000	1.6 (0.73)	11.25" (286)	0.25" (6.35) 
EP2612N	115 V AC	11.0 – 26.0 (1.2 – 2.9)	1,200	1.6 (0.73)	11.25" (286)	0.25" (6.35) 
EP2607N	115 V AC	11.0 – 26.0 (1.2 – 2.9)	700	1.6 (0.73)	11.25" (286)	0.25" (6.35) 
EP2603N	115 V AC	11.0 – 26.0 (1.2 – 2.9)	300	1.6 (0.73)	11.25" (286)	0.25" (6.35) 
DC INLINE LEVER START						
EL1520N	115 V AC	5.0 – 15.0 (0.6 – 1.7)	2,000	1.63 (0.74)	11.25" (286)	0.25" (6.35) 
EL1510N	115 V AC	5.0 – 15.0 (0.6 – 1.7)	1,000	1.63 (0.74)	11.25" (286)	0.25" (6.35) 
EL2612N	115 V AC	11.0 – 26.0 (1.2 – 2.9)	1,200	1.63 (0.74)	11.25" (286)	0.25" (6.35) 
EL2607N	115 V AC	11.0 – 26.0 (1.2 – 2.9)	700	1.63 (0.74)	11.25" (286)	0.25" (6.35) 
EL2603N	115 V AC	11.0 – 26.0 (1.2 – 2.9)	300	1.63 (0.74)	11.25" (286)	0.25" (6.35) 
DC TRIGGER START WITH PISTOL ATTACHMENT						
ET4007N	115 V AC	18.0 – 40.0 (2.0 – 4.5)	700	1.83 (0.83)	11.25" (286)	0.25" (6.35) 
DC PUSH-TO-START WITH PISTOL ATTACHMENT						
EP4007N	115 V AC	18.0 – 40.0 (2.0 – 4.5)	700	1.83 (0.83)	11.25" (286)	0.25" (6.35) 

High-Torque ES Series



Proven performance in an economical package.

Features

- Torque Range: 4.0 – 40.0 in-lbs (0.5 – 4.5 Nm)
- Speeds: 400 – 2,000 rpm
- 115 V AC plug in with integral 3 m cable
- Precise torque control for more efficient and accurate production
- Two bits, two brushes, and hanger bail included
- Recommended for applications where precise torque control is required

Service and Accessories















Manuals:

-  45527751
-  45527611
-  45527785

Accessories:

- Balancer, see page 177
- Shaker box, see page 16
- Bits, see page 17
- Pistol grip handle: DLW2100TP



						
Model	V	in-lbs (Nm)	rpm	lb (kg)	in (mm)	in (mm)
DC INLINE PUSH-TO-START						
ES90P	115 V AC	4.4 – 16.0 (0.5 – 1.8)	2,000	1.50 (0.68)	10.00" (254)	0.25" (6.35) 
ES60P	115 V AC	4.4 – 17.0 (0.5 – 1.9)	1,000	1.50 (0.68)	10.00" (254)	0.25" (6.35) 
ES80P	115 V AC	12.0 – 24.0 (1.4 – 2.7)	1,200	1.50 (0.68)	10.00" (254)	0.25" (6.35) 
ES70P	115 V AC	10.0 – 26.0 (1.1 – 2.9)	700	1.50 (0.68)	10.00" (254)	0.25" (6.35) 
DC INLINE LEVER START						
ES90T	115 V AC	4.4 – 16.0 (0.5 – 1.8)	2,000	1.53 (0.69)	10.00" (254)	0.25" (6.35) 
ES60T	115 V AC	4.4 – 17.0 (0.5 – 1.9)	1,000	1.53 (0.69)	10.00" (254)	0.25" (6.35) 
ES70T	115 V AC	10.0 – 26.0 (1.1 – 2.9)	700	1.53 (0.69)	10.00" (254)	0.25" (6.35) 
DC TRIGGER START WITH PISTOL ATTACHMENT						
ES100T	115 V AC	15.0 – 40.0 (1.9 – 4.5)	400	1.68 (0.76)	10.00" (254)	0.25" (6.35) 
DC PUSH-TO-START WITH PISTOL ATTACHMENT						
ES100P	115 V AC	15.0 – 40.0 (1.9 – 4.5)	400	1.65 (0.75)	10.00" (254)	0.25" (6.35) 

Electric Screwdrivers

Angle

High-Torque Versatec

Sets the standards for ergonomics and operator convenience.

Features

- Torque Range: 5.0 – 60.0 in-lbs (0.6 – 6.8 Nm)
- Speeds: 450 – 1,850 rpm
- 115 V AC plug in with detachable 8 foot cable
- Ergonomic package features contoured soft-touch grip, two-finger lever actuation, and easy forward reverse control providing the ultimate in operator comfort and productivity
- Removable contoured flange and torque adjustment cover protects torque setting while giving instant visible confirmation in readout window
- Brush replacement light signals when maintenance is required
- Dual-position cord allows optimal cable routing
- Small angleheads designed for close quarter applications
- Angleheads rotate 360 degrees
- Two bits, two brushes, and hanger bail included
- Recommended for applications where precise torque control is required



EL1510N2S5

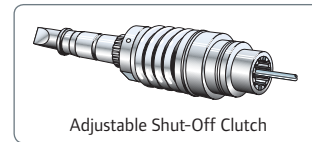

Adjustable Shut-Off Clutch

Service and Accessories

Manuals:

- 45530102
- 45527579
- 45530110

Accessories:

- Balancer, see page 177
- Pistol grip handle: EP4007N-48
- Sockets, see form # IR-0506-016

Model	V	in-lbs (Nm)	rpm	lb (kg)	in (mm)	in (mm)	in (mm)	in
LEVER START LARGE ANGLE HEAD								
EL1510N2S5	115 V AC	8 – 23 (0.9 – 2.6)	650	2.20 (1.00)	17.64" (448)	0.52" (13.21)	1.73" (43.94)	1/4"
EL2612N2S5	115 V AC	17 – 40 (1.9 – 4.5)	800	2.20 (1.00)	17.64" (448)	0.52" (13.21)	1.73" (43.94)	1/4"
ET4007N2S5	115 V AC	27 – 60 (3.0 – 6.8)	450	2.20 (1.00)	17.64" (448)	0.52" (13.21)	1.73" (43.94)	1/4"
EL1510N2S3	115 V AC	8 – 23 (0.9 – 2.6)	650	2.20 (1.00)	17.64" (448)	0.52" (13.21)	1.73" (43.94)	1/4"
EL2612N2S3	115 V AC	17 – 40 (1.9 – 4.5)	800	2.20 (1.00)	17.64" (448)	0.52" (13.21)	1.73" (43.94)	1/4"
ET4007N2S3	115 V AC	27 – 60 (3.0 – 6.8)	450	2.20 (1.00)	17.64" (448)	0.52" (13.21)	1.73" (43.94)	1/4"
LEVER START SMALL ANGLE HEAD								
EL1520N1S5*	115 V AC	5 – 15 (0.6 – 1.7)	1,850	2.00 (0.91)	17.45" (443)	0.33" (8.38)	1.47" (37.34)	1/4"
EL1510N1S5*	115 V AC	5 – 15 (0.6 – 1.7)	950	2.00 (0.91)	17.45" (443)	0.33" (8.38)	1.47" (37.34)	1/4"
EL2612N1S5*	115 V AC	11 – 26 (1.2 – 2.9)	1,100	2.00 (0.91)	17.45" (443)	0.33" (8.38)	1.47" (37.34)	1/4"

*This head is designed for close-quarter applications. Not intended for extensive counterclockwise use. Angle heads can rotate 360 degrees for application adjustment. Torque output will vary with application.

High-Torque ES Series

Proven performance in an economical package.

Features

- Torque Range: 4.0 – 56.0 in-lbs (0.45 – 6.3 Nm)
- Speeds: 250 – 1,850 rpm
- 115 V AC plug in with integral 3 m cable
- Precise torque control for more efficient and accurate production
- Small angleheads designed for close-quarter applications
- Angleheads rotate 360 degrees
- Two bits, two brushes, and hanger bail included
- Recommended for applications where precise torque control is required



ES70T2S3

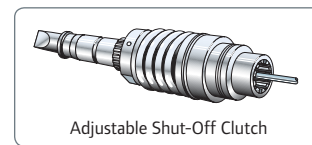

Adjustable Shut-Off Clutch

Service and Accessories

Manuals:

- 45527769
- 45527678

Accessories:

- Balancer, see page 177
- Pistol grip handle; EP4007N-48
- Sockets, see form # IR-0506-016

Model	V	in-lbs (Nm)	rpm	lb (kg)	in (mm)	in (mm)	in (mm)	in
AC LEVER START LARGE ANGLE HEAD								
ES90T2S3	115 VAC	6 – 19 (0.68 – 2.2)	1,300	2.1 (0.95)	16.89" (429)	0.52" (13.21)	1.99" (50.55)	1/4"
ES60T2S3	115 VAC	6 – 23 (0.68 – 2.6)	650	2.1 (0.95)	16.89" (429)	0.52" (13.21)	1.99" (50.55)	1/4"
ES70T2S3	115 VAC	11 – 36 (1.2 – 4.1)	450	2.1 (0.95)	16.89" (429)	0.52" (13.21)	1.99" (50.55)	1/4"
ES100T2S3	115 VAC	14 – 56 (1.6 – 6.3)	250	2.1 (0.95)	16.89" (429)	0.52" (13.21)	1.99" (50.55)	1/4"
ES90T2S5	115 VAC	6 – 19 (0.68 – 2.2)	1,300	2.1 (0.95)	16.89" (429)	0.52" (13.21)	1.73" (43.94)	1/4"
ES60T2S5	115 VAC	6 – 23 (0.68 – 2.6)	650	2.1 (0.95)	16.89" (429)	0.52" (13.21)	1.73" (43.94)	1/4"
ES70T2S5	115 VAC	11 – 36 (1.2 – 4.1)	450	2.1 (0.95)	16.89" (429)	0.52" (13.21)	1.73" (43.94)	1/4"
ES100T2S5	115 VAC	14 – 56 (1.6 – 6.3)	250	2.1 (0.95)	16.89" (429)	0.52" (13.21)	1.73" (43.94)	1/4"
AC LEVER START SMALL ANGLE HEAD								
ES90T1S5	115 VAC	4 – 14 (0.45 – 1.6)	1,850	1.9 (0.86)	16.70" (424)	0.33" (8.38)	1.47" (37.34)	1/4"
ES60T1S5	115 VAC	4 – 17 (0.45 – 1.9)	950	1.9 (0.86)	16.70" (424)	0.33" (8.38)	1.47" (37.34)	1/4"
ES70T1S5	115 VAC	8 – 26 (0.90 – 2.9)	650	1.9 (0.86)	16.70" (424)	0.33" (8.38)	1.47" (37.34)	1/4"

Electric Screwdrivers

Accessories

Torque Adjustment Covers

Part Number	Description	For Use With
ES60T-675	Torque Adjustment Cover	ES60, ES70, ES80, ES90, ES100
EL0410BC-46	Torque Adjustment Cover	Low-Torque VersaTec
EL0410BC-46-ESD	Torque Adjustment Cover	Low-Torque VersaTec - ESD

Suspension Bails

Part Number	Description	For Use With
EP4007N-365	Vertical Suspension Bail	High-Torque VersaTec
EP4007N-366	Horizontal Suspension Bail	High-Torque VersaTec
EL0109B-365	Vertical Suspension Bail	Low-Torque VersaTec
DAA40-A366	Horizontal Hanger	Electric angle screwdrivers

Power and Extension Cords

Part Number	Description	For Use With
EL0109B-239	Power Cord Assembly	High-Torque VersaTec
ES40T-249	Power Cord Assembly	Low-Torque ES
EP4007N-239-C6A	6' Coiled Extension Cord	High-Torque VersaTec
EP4007N-239-8A	8' Coiled Extension Cord	High-Torque VersaTec
EP4007N-239-12A	12' Coiled Extension Cord	High-Torque VersaTec
EP4007N-239-25	25' Coiled Extension Cord	High-Torque VersaTec
ES40T-249-2	6.5' Extension Cord	Low-Torque ES and VersaTec

Other Accessories

Part Number	Description	Shape	For Use With
EP4007N-516	Torque Adjusting Wrench	N/A	VersaTec Models
DLW3402	Plastic Screw Shaker Box	5-1/2" x 3-7/8"	Screw sizes 0 - 2 mm (0.07" - 0.08")
DLW3602	Plastic Screw Shaker Box	5-1/2" x 3-7/8"	Screw sizes 1 - 4 mm (0.08" - 0.11")
DLW3802	Plastic Screw Shaker Box	6-11/16" x 4-7/8"	Screw sizes 3 - 8 mm (0.12" - 0.16")



Pistol Attachment

Part Number	Description	For Use With
EP4007N-48	Attachable Pistol Grip handle	High-Torque VersaTec
DLW2100TP	Attachable Pistol Grip handle	ES60, ES70 ES80, ES90, EPB, ELB

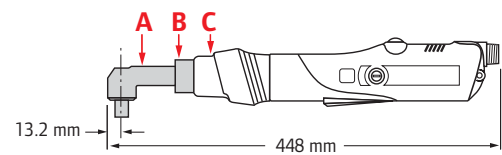

Angle Head Conversion

Component	Part Number	Description
A	3RL23	1/4" Quick Change
A	3RL25	1/4" Square Drive
B	EL4007N2S5-AHC	Coupling Nut
C	ET4007N2S5-580	Clutch Cover

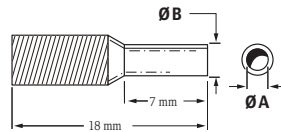

Vacuum Pick-Up Sleeves

Part Number	Complementing Bit Part Number	"A" Inside Diameter in (mm)	"B" Outside Diameter in (mm)
DLS2120	DLB2122-10	0.079" (2.0)	0.138" (3.5)
DLS2122	DLB2122-10	0.098" (2.5)	0.138" (3.5)
DLS2123	DLB2122-10	0.106" (2.7)	0.138" (3.5)
DLS2124	DLB2122-10	0.122" (3.1)	0.138" (3.5)
DLS2125	DLB2124-10	0.130" (3.3)	0.177" (4.5)
DLS2126	DLB2124-10	0.138" (3.5)	0.177" (4.5)
DLS2127	DLB2124-10	0.146" (3.7)	0.177" (4.5)
DLS2128	DLB2126-10	0.158" (4.0)	0.177" (4.5)
DLS2129	DLB2126-10	0.165" (4.2)	0.212" (5.5)
DLS2130	DLB2126-10	0.177" (4.5)	0.212" (5.5)
DLS2131	DLB2128-10, DLB2130-10, XP161, XRP161	0.185" (4.7)	0.212" (5.5)
DLS2132	DLB2128-10, DLB2130-10, XP161, XRP161	0.201" (5.1)	0.212" (5.5)
DLS2133	DLB2128-10, DLB2130-10, XP161, XRP161	0.209" (5.3)	0.256" (6.5)
DLS2134	DLB2128-10, DLB2130-10, XP161, XRP161	0.221" (5.6)	0.256" (6.5)
EL0410BC-53	DLB2128-10, DLB2130-10, XP161, XRP161	0.240" (6.1)	0.276" (7.0)

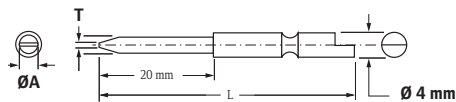

Slot Bits

Part Number	"T" Size in	"A" Diameter in (mm)	"L" Length in	Screw Size Range	Quantity
DLB2220-10	0.012	0.079" (2.0)	1.7"	00 - 0	10
DLB2221-10	0.012	0.098" (2.5)	1.7"	00 - 0	10
DLB2222-10	0.016	0.117" (3.0)	1.7"	0 - 2	10
DLB2223-10	0.02	0.157" (4.0)	1.7"	2 - 4	10
DLB2224-10	0.026	0.197" (5.0)	1.7"	3 - 5	10

Phillips Bits

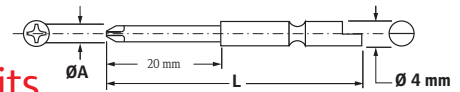

Part Number	Point Size	"A" Diameter in (mm)	"L" Length in	Screw Size Range	Quantity
DLB2120-10	0	0.071" (1.8)	1.7"	0 - 1	10
DLB2121-10	0	0.071" (1.8)	2.5"	0 - 1	10
DLB2122-10	0	0.079" (2.0)	1.7"	00 - 0	10
DLB2123-10	0	0.079" (2.0)	2.5"	00 - 0	10
DLB2124-10	0	0.098" (2.5)	1.7"	0 - 1	10
DLB2125-10	0	0.098" (2.5)	2.5"	0 - 1	10
DLB2126-10	1	0.118" (3.0)	1.7"	2 - 4	10
DLB2127-10	1	0.118" (3.0)	2.5"	2 - 4	10
DLB2128-10	1	0.157" (4.0)	1.7"	2 - 4	10
DLB2129-10	1	0.157" (4.0)	2.5"	2 - 4	10
DLB2130-10	2	0.157" (4.0)	1.7"	5 - 10	10
DLB2131-10	2	0.157" (4.0)	2.5"	5 - 10	10
DLB2132-10	3	0.236" (6.0)	1.7"	10 - 1/4	10

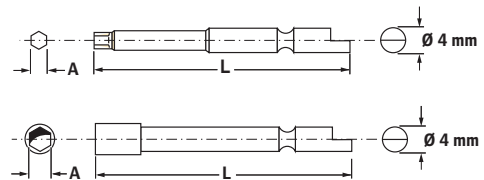

Hexagon, Male and Female

Part Number	Screw Size	"A" Hex Size in (mm)	"L" Length in	Use Diagram	Quantity
DLB2321-10	0.12	0.059" (1.5)	1.7"	Male	10
DLB2322-10	0.16	0.079" (2.0)	1.7"	Male	10
DLB2323-10	0.24	0.118" (3.0)	1.7"	Male	10
DLB2324-10	0.31	0.157" (4.0)	1.7"	Male	10
DLB2420-10	N/A	0.091" (2.3)	1.7"	Female	10
DLB2421-10	N/A	0.098" (2.5)	1.7"	Female	10
DLB2422-10	N/A	0.118" (3.0)	1.7"	Female	10
DLB2423-10	0.08	0.157" (4.0)	1.7"	Female	10
DLB2424-10	0.09	0.177" (4.5)	1.7"	Female	10
DLB2425-10	0.1	0.197" (5.0)	1.7"	Female	10
DLB2426-10	0.12	0.217" (5.5)	1.7"	Female	10

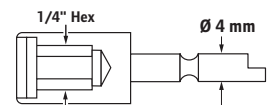

Insert Bit Holders

Part Number	Description	For Use With
DLW-4100	Slotted Bit Holder	EL0109B / "Micro" / SS-ESD



DC Electric Nutrunners

Torque Selection Guide

Category	Torque Selection Guide						Referral page
	0 Nm	5 Nm	10 Nm	15 Nm	20 Nm	25 Nm	
Inline Push-to-Start	Model						
	QE4TS010R11...						19
	QE4TS015R11...						19
	QE4TS020R11...						19
QE4TS025R11...						19	
Pistol Grip	Model						
	QE4PT010P10...						20
	QE4PT015P10...						20
	QE4PT020P10...						20
QE4PT025P10...						20	
Inline	Model						
	QE4ST010B...						22
	QE4ST015B...						22
	QE4ST020B...						23
	QE6ST020F...						24
	QE4ST025B...						23
	QE6ST028F...						24
	QE6ST033F...						24
	QE6ST050F...						24
	QE8ST055F...						25
	QE8ST070F...						25
	QE8ST090F...						25
	QE8ST150F...						25
QE8ST230F...						25	
Inline Offset	Model						
	QE6ZC020...						26
	QE6ZC028...						26
	QE6ZC033...						26
	QE6ZC050...						26
	QE8ZC055...						27
	QE8ZC070...						27
	QE8ZC090...						27
QE8ZC150...						27	
Angle	Model						
	QE4AT013P...						28
	QE4AT020P...						28
	QE4AT027P...						28
	QE6AT030P...						29
	QE4AT034P...						28
	QE6AT040P...						29
	QE6AT055P...						29
	QE8AT065P...						29
	QE8AT070P...						29
	QE6AT080P...						29
	QE8AT090P...						29
	QE8AT115P...						29
	QE8AT150P...						29
	QE8AT225P...						29
QE8AT400P...						29	

DC Electric Nutrunners

Push-to-Start

QE4 Push-to-Start Inline

Offering accurate, high-speed, one-handed operation, this tool is activated when the operator presses down on the fastener. This eliminates the need for a lever, saving time and effort. The tool's unique clevis attachment allows for easy attachment to torque arms while offering the operator optimal hand positioning and workpiece visibility.



QE4TS010R11Q04

Features

- Torque Range: 0.75 – 18.3 ft-lbs (1 – 25 Nm)
- Speeds: Adjustable to 1820 rpm
- True closed-loop transducerized control provides exceptional accuracy
- Advanced tightening strategies and data and process communications
- Compact, high-speed, easily accessible controls
- Non-contacting switches, heavy-duty gear train, and DC brushless motor provide exceptional durability
- TactAlert provides positive feedback to the operator without distracting from the task
- Preventive maintenance alerts
- Comfortable ergonomic grip
- High-temperature motor protection
- Easy-to-use reverse ring
- Bright LEDs provide visible status indicators

Service and Accessories

Manuals:

- 16574451
- 19576951
- 16575151

Accessories:

- Reaction bar kit: GEPTS15-K48
- Torque arms, see page 180
- Cable, see page 47
- ICD & M controllers, see page 39

Model	ft-lbs (Nm)	rpm	lbs (kg)	in (mm)	in (mm)	in
DC INLINE PUSH-TO-START						
QE4TS010R11Q04	0.75 – 7.4 (1 – 10)	1,820	2.6 (1.2)	14.2" (363)	0.98" (25)	1/4"
QE4TS010R11S04	0.75 – 7.4 (1 – 10)	1,820	2.6 (1.2)	13.4" (343)	0.98" (25)	1/4"
QE4TS010R11S06	0.75 – 7.4 (1 – 10)	1,820	2.6 (1.2)	13.4" (343)	0.98" (25)	3/8"
QE4TS015R11Q04	1.1 – 11.0 (1.5 – 15)	1,220	2.6 (1.2)	14.2" (363)	0.98" (25)	1/4"
QE4TS015R11S04	1.1 – 11.0 (1.5 – 15)	1,220	2.6 (1.2)	13.4" (343)	0.98" (25)	1/4"
QE4TS015R11S06	1.1 – 11.0 (1.5 – 15)	1,220	2.6 (1.2)	13.4" (343)	0.98" (25)	3/8"
QE4TS020R11S06	1.5 – 14.7 (2 – 20)	900	2.6 (1.2)	13.4" (343)	0.98" (25)	3/8"
QE4TS025R11S06	1.8 – 18.3 (2.5 – 25)	710	2.6 (1.2)	13.4" (343)	0.98" (25)	3/8"

DC Electric Nutrunners

Pistol Grip

QE4 Pistol

Provides the utility of a pistol tool while delivering the accuracy of a closed-loop transducerized DC system. With three modes of activation, bright LED headlight, and a standard reaction bar, this tool meets all the requirements of the most demanding jobs when teamed with an IC controller.

Features

- Torque Range: 0.75 – 18.3 ft-lbs (1 – 25 Nm)
- Speeds: Adjustable to 1820 rpm
- True closed-loop transducerized control provides exceptional accuracy
- Advanced tightening strategies and data and process communications
- Non-contacting switches, heavy-duty gear train, and DC brushless motor provide exceptional durability
- Bright LED headlight
- Compact, high-speed, easily accessible controls
- Comfortable ergonomic grip
- Preventive maintenance alerts
- High-temperature motor protection
- Bright LEDs provide visible status indicators
- TactAlert provides positive feedback to the operator without distracting from the task
- Reaction bar standard



QE4PT015P10S04

Service and Accessories























Manuals:

- 80151632
- 80151590
- 80151624

Accessories:

- Torque arms, page 180
- Cables, page 47
- ICD & M controller, page 39

Model	ft-lbs (Nm)	rpm	lbs (kg)	in (mm)	in (mm)	in
DC TRIGGER + PUSH-TO-START						
QE4PP010P11Q04	0.75 – 7.4 (1 – 10)	1,820	2.9 (1.3)	9.5" (243)	0.8" (20.3)	1/4"
QE4PP010P11S04	0.75 – 7.4 (1 – 10)	1,820	2.9 (1.3)	9.0" (230)	0.8" (20.3)	1/4"
QE4PP010P11S06	0.75 – 7.4 (1 – 10)	1,820	2.9 (1.3)	9.1" (234)	0.8" (20.3)	3/8"
QE4PP015P11Q04	1.1 – 11.0 (1.5 – 15)	1,220	2.9 (1.3)	9.5" (243)	0.8" (20.3)	1/4"
QE4PP015P11S04	1.1 – 11.0 (1.5 – 15)	1,220	2.9 (1.3)	9.0" (230)	0.8" (20.3)	1/4"
QE4PP015P11S06	1.1 – 11.0 (1.5 – 15)	1,220	2.9 (1.3)	9.1" (234)	0.8" (20.3)	3/8"
QE4PP020P11S06	1.5 – 14.7 (2 – 20)	900	2.9 (1.3)	9.1" (234)	0.8" (20.3)	3/8"
QE4PP025P11S06	1.8 – 18.3 (2.5 – 25)	710	2.9 (1.3)	9.1" (234)	0.8" (20.3)	3/8"

						
Model	ft-lbs (Nm)	rpm	lbs (kg)	in (mm)	in (mm)	in
DC PUSH-TO-START						
QE4PS010P11Q04	0.75 – 7.4 (1 – 10)	1,820	2.9 (1.3)	9.5" (243)	0.8" (20.3)	1/4" 
QE4PS010P11S04	0.75 – 7.4 (1 – 10)	1,820	2.9 (1.3)	9.0" (230)	0.8" (20.3)	1/4" 
QE4PS010P11S06	0.75 – 7.4 (1 – 10)	1,820	2.9 (1.3)	9.1" (234)	0.8" (20.3)	3/8" 
QE4PS015P11Q04	1.1 – 11.0 (1.5 – 15)	1,220	2.9 (1.3)	9.5" (243)	0.8" (20.3)	1/4" 
QE4PS015P11S04	1.1 – 11.0 (1.5 – 15)	1,220	2.9 (1.3)	9.0" (230)	0.8" (20.3)	1/4" 
QE4PS015P11S06	1.1 – 11.0 (1.5 – 15)	1,220	2.9 (1.3)	9.1" (234)	0.8" (20.3)	3/8" 
QE4PS020P11S06	1.5 – 14.7 (2 – 20)	900	2.9 (1.3)	9.1" (234)	0.8" (20.3)	3/8" 
QE4PS025P11S06	1.8 – 18.3 (2.5 – 25)	710	2.9 (1.3)	9.1" (234)	0.8" (20.3)	3/8" 
DC TRIGGER START						
QE4PT010P10Q04	0.75 – 7.4 (1 – 10)	1,820	2.9 (1.3)	9.5" (243)	0.8" (20.3)	1/4" 
QE4PT010P10S04	0.75 – 7.4 (1 – 10)	1,820	2.9 (1.3)	9.0" (230)	0.8" (20.3)	1/4" 
QE4PT010P10S06	0.75 – 7.4 (1 – 10)	1,820	2.9 (1.3)	9.1" (234)	0.8" (20.3)	3/8" 
QE4PT015P10Q04	1.1 – 11.0 (1.5 – 15)	1,220	2.9 (1.3)	9.5" (243)	0.8" (20.3)	1/4" 
QE4PT015P10S04	1.1 – 11.0 (1.5 – 15)	1,220	2.9 (1.3)	9.0" (230)	0.8" (20.3)	1/4" 
QE4PT015P10S06	1.1 – 11.0 (1.5 – 15)	1,220	2.9 (1.3)	9.1" (234)	0.8" (20.3)	3/8" 
QE4PT020P10S06	1.5 – 14.7 (2 – 20)	900	2.9 (1.3)	9.1" (234)	0.8" (20.3)	3/8" 
QE4PT025P10S06	1.8 – 18.3 (2.5 – 25)	710	2.9 (1.3)	9.1" (234)	0.8" (20.3)	3/8" 

DC Electric Nutrunners

Inline

QE Series Inlines

A proven world-class combination — QE tools and IC Series controllers team up to provide superior accuracy and durability and meet your critical fastening requirements. The non-contacting switches, heavy-duty gear train, and DC brushless motor create a durable package while the compact, ergonomic design and easily accessible controls help operators keep production lines running smoothly.



QE4ST010B21Q04

Features

- Torque Range: 0.75 – 169 ft-lbs (1.0 – 230 Nm)
- Speeds: Adjustable to 1,840 rpm
- True closed-loop transducerized control provides exceptional accuracy
- Advanced tightening strategies and data and process communications
- TactAlert provides positive feedback to the operator without distracting from the task
- Compact, high-speed, easily accessible controls
- Bright LEDs provide visible status indicators
- Comfortable ergonomic grip
- High-temperature motor protection
- Preventive maintenance alerts

Service and Accessories

Factory-Direct Options for QE4, QE6 and QE8

Activation: Fifth Digit QE8S() Mounting: Ninth Digit QE8ST230()
 T = Trigger P = No Mount
 L = Lever F = Flanged Mount
 E = Extended Lever R = Reaction Bar Mount
 C = Machine Start B = Flange Mount Kit
 J = Two-Piece Mounting Plate

Manuals:





































- 16574451
- 16576951
- 16575151

Accessories:

Torque arms, see page 180
 Cables, see page 47
 Smart socket trays, see page 48
 Mounting flanges, see page 47
 Extended lever, see page 47
 ICD & M controllers, see page 39
 Hanger accessories, see page 47
 Spindle accessories, see page 183

Spindle Length: Tenth Digit QE8ST230F()

Model	ft-lbs (Nm)	rpm	lbs (kg)	in (mm)	in (mm)	in	in (mm)
DC QE4 INLINE							
QE4ST010B20Q04	0.75 – 7.4 (1 – 10)	1,820	2.65 (1.2)	16" (406)	0.95" (24.25)	1/4"	0" (0)
QE4ST010B20S04	0.75 – 7.4 (1 – 10)	1,820	2.65 (1.2)	16" (406)	0.95" (24.25)	1/4"	0" (0)
QE4ST010B20S06	0.75 – 7.4 (1 – 10)	1,820	2.65 (1.2)	16" (406)	0.95" (24.25)	3/8"	0" (0)
QE4ST010B21Q04	0.75 – 7.4 (1 – 10)	1,820	2.65 (1.2)	16" (406)	0.95" (24.25)	1/4"	1.50" (38)
QE4ST010B21S04	0.75 – 7.4 (1 – 10)	1,820	2.65 (1.2)	16" (406)	0.95" (24.25)	1/4"	1.50" (38)
QE4ST010B21S06	0.75 – 7.4 (1 – 10)	1,820	2.65 (1.2)	16" (406)	0.95" (24.25)	3/8"	1.50" (38)
QE4ST010B21S08	0.75 – 7.4 (1 – 10)	1,820	2.65 (1.2)	16" (406)	0.95" (24.25)	1/2"	1.50" (38)
QE4ST010B41Q04	0.75 – 7.4 (1 – 10)	1,820	2.87 (1.3)	18" (457)	0.95" (24.25)	1/4"	1.50" (38)
QE4ST010B41S04	0.75 – 7.4 (1 – 10)	1,820	2.87 (1.3)	18" (457)	0.95" (24.25)	1/4"	1.50" (38)
QE4ST010B41S06	0.75 – 7.4 (1 – 10)	1,820	2.87 (1.3)	18" (457)	0.95" (24.25)	3/8"	1.50" (38)
QE4ST010B41S08	0.75 – 7.4 (1 – 10)	1,820	2.87 (1.3)	18" (457)	0.95" (24.25)	1/2"	1.50" (38)
QE4ST015B20Q04	1.1 – 11.0 (1.5 – 15)	1,220	2.65 (1.2)	16" (406)	0.95" (24.25)	1/4"	0" (0)
QE4ST015B20S04	1.1 – 11.0 (1.5 – 15)	1,220	2.65 (1.2)	16" (406)	0.95" (24.25)	1/4"	0" (0)
QE4ST015B20S06	1.1 – 11.0 (1.5 – 15)	1,220	2.65 (1.2)	16" (406)	0.95" (24.25)	3/8"	0" (0)

							
Model	ft-lbs (Nm)	rpm	lbs (kg)	in (mm)	in (mm)	in	in (mm)
QC QE4 INLINE (CONTINUED)							
QE4ST015B21Q04	1.1 – 11.0 (1.5 – 15)	1,220	2.65 (1.2)	16" (406)	0.95" (24.25)	1/4" 	1.50" (38)
QE4ST015B21S04	1.1 – 11.0 (1.5 – 15)	1,220	2.65 (1.2)	16" (406)	0.95" (24.25)	1/4" 	1.50" (38)
QE4ST015B21S06	1.1 – 11.0 (1.5 – 15)	1,220	2.65 (1.2)	16" (406)	0.95" (24.25)	3/8" 	1.50" (38)
QE4ST015B21S08	1.1 – 11.0 (1.5 – 15)	1,220	2.65 (1.2)	16" (406)	0.95" (24.25)	1/2" 	1.50" (38)
QE4ST015B41Q04	1.1 – 11.0 (1.5 – 15)	1,220	2.87 (1.3)	16" (406)	0.95" (24.25)	1/4" 	1.50" (38)
QE4ST015B41S04	1.1 – 11.0 (1.5 – 15)	1,220	2.87 (1.3)	16" (406)	0.95" (24.25)	1/4" 	1.50" (38)
QE4ST015B41S06	1.1 – 11.0 (1.5 – 15)	1,220	2.87 (1.3)	16" (406)	0.95" (24.25)	3/8" 	1.50" (38)
QE4ST015B41S08	1.1 – 11.0 (1.5 – 15)	1,220	2.87 (1.3)	16" (406)	0.95" (24.25)	1/2" 	1.50" (38)
QE4ST020B20Q04	1.5 – 14.7 (2 – 20)	900	2.65 (1.2)	16" (406)	0.95" (24.25)	1/4" 	0" (0)
QE4ST020B20S04	1.5 – 14.7 (2 – 20)	900	2.65 (1.2)	16" (406)	0.95" (24.25)	1/4" 	0" (0)
QE4ST020B20S06	1.5 – 14.7 (2 – 20)	900	2.65 (1.2)	16" (406)	0.95" (24.25)	3/8" 	0" (0)
QE4ST020B21Q04	1.5 – 14.7 (2 – 20)	900	2.65 (1.2)	16" (406)	0.95" (24.25)	1/4" 	1.50" (38)
QE4ST020B21S04	1.5 – 14.7 (2 – 20)	900	2.65 (1.2)	16" (406)	0.95" (24.25)	1/4" 	1.50" (38)
QE4ST020B21S06	1.5 – 14.7 (2 – 20)	900	2.65 (1.2)	16" (406)	0.95" (24.25)	3/8" 	1.50" (38)
QE4ST020B21S08	1.5 – 14.7 (2 – 20)	900	2.65 (1.2)	16" (406)	0.95" (24.25)	1/2" 	1.50" (38)
QE4ST020B41Q04	1.5 – 14.7 (2 – 20)	900	2.87 (1.3)	18" (457)	0.95" (24.25)	1/4" 	1.50" (38)
QE4ST020B41S04	1.5 – 14.7 (2 – 20)	900	2.87 (1.3)	18" (457)	0.95" (24.25)	1/4" 	1.50" (38)
QE4ST020B41S06	1.5 – 14.7 (2 – 20)	900	2.87 (1.3)	18" (457)	0.95" (24.25)	3/8" 	1.50" (38)
QE4ST020B41S08	1.5 – 14.7 (2 – 20)	900	2.87 (1.3)	18" (457)	0.95" (24.25)	1/2" 	1.50" (38)
QE4ST025B20Q04	1.8 – 18.3 (2.5 – 25)	710	2.65 (1.2)	16" (406)	0.95" (24.25)	1/4" 	0" (0)
QE4ST025B20S04	1.8 – 18.3 (2.5 – 25)	710	2.65 (1.2)	16" (406)	0.95" (24.25)	1/4" 	0" (0)
QE4ST025B20S06	1.8 – 18.3 (2.5 – 25)	710	2.65 (1.2)	16" (406)	0.95" (24.25)	3/8" 	0" (0)
QE4ST025B21Q04	1.8 – 18.3 (2.5 – 25)	710	2.65 (1.2)	16" (406)	0.95" (24.25)	1/4" 	1.50" (38)
QE4ST025B21S04	1.8 – 18.3 (2.5 – 25)	710	2.65 (1.2)	16" (406)	0.95" (24.25)	1/4" 	1.50" (38)
QE4ST025B21S06	1.8 – 18.3 (2.5 – 25)	710	2.65 (1.2)	16" (406)	0.95" (24.25)	3/8" 	1.50" (38)
QE4ST025B21S08	1.8 – 18.3 (2.5 – 25)	710	2.65 (1.2)	16" (406)	0.95" (24.25)	1/2" 	1.50" (38)
QE4ST025B41Q04	1.8 – 18.3 (2.5 – 25)	710	2.87 (1.3)	18" (457)	0.95" (24.25)	1/4" 	1.50" (38)
QE4ST025B41S04	1.8 – 18.3 (2.5 – 25)	710	2.87 (1.3)	18" (457)	0.95" (24.25)	1/4" 	1.50" (38)
QE4ST025B41S06	1.8 – 18.3 (2.5 – 25)	710	2.87 (1.3)	18" (457)	0.95" (24.25)	3/8" 	1.50" (38)
QE4ST025B41S08	1.8 – 18.3 (2.5 – 25)	710	2.87 (1.3)	18" (457)	0.95" (24.25)	1/2" 	1.50" (38)

DC Electric Nutrunners

Inline

Manuals:































16574469







16576951













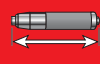











16575169

Model	 ft-lbs (Nm)	 rpm	 lbs (kg)	 in (mm)	 in (mm)	 in	 in (mm)
DC QE6 INLINE							
QE6ST020F41S06	1.5 – 14.7 (2 – 20)	1,840	4.63 (2.1)	19.72" (501)	1.08" (27.35)	3/8" 	1.50" (38)
QE6ST020F41S08	1.5 – 14.7 (2 – 20)	1,840	4.63 (2.1)	19.72" (501)	1.08" (27.35)	1/2" 	1.50" (38)
QE6ST020F61S06	1.5 – 14.7 (2 – 20)	1,840	4.85 (2.2)	21.42" (544)	1.08" (27.35)	3/8" 	1.50" (38)
QE6ST020F61S08	1.5 – 14.7 (2 – 20)	1,840	4.85 (2.2)	21.42" (544)	1.08" (27.35)	1/2" 	1.50" (38)
QE6ST020F81S06	1.5 – 14.7 (2 – 20)	1,840	5.07 (2.3)	23.39" (594)	1.08" (27.35)	3/8" 	1.50" (38)
QE6ST020F81S08	1.5 – 14.7 (2 – 20)	1,840	5.07 (2.3)	23.39" (594)	1.08" (27.35)	1/2" 	1.50" (38)
QE6ST028F41S06	2.0 – 20 (2.8 – 28)	1,360	4.63 (2.1)	19.72" (501)	1.08" (27.35)	3/8" 	1.50" (38)
QE6ST028F41S08	2.0 – 20 (2.8 – 28)	1,360	4.63 (2.1)	19.72" (501)	1.08" (27.35)	1/2" 	1.50" (38)
QE6ST028F61S06	2.0 – 20 (2.8 – 28)	1,360	4.85 (2.2)	21.42" (544)	1.08" (27.35)	3/8" 	1.50" (38)
QE6ST028F61S08	2.0 – 20 (2.8 – 28)	1,360	4.85 (2.2)	21.42" (544)	1.08" (27.35)	1/2" 	1.50" (38)
QE6ST028F81S06	2.0 – 20 (2.8 – 28)	1,360	5.07 (2.3)	23.39" (594)	1.08" (27.35)	3/8" 	1.50" (38)
QE6ST028F81S08	2.0 – 20 (2.8 – 28)	1,360	5.07 (2.3)	23.39" (594)	1.08" (27.35)	1/2" 	1.50" (38)
QE6ST033F41S06	2.4 – 24 (3.3 – 33)	1,130	4.63 (2.1)	19.72" (501)	1.08" (27.35)	3/8" 	1.50" (38)
QE6ST033F41S08	2.4 – 24 (3.3 – 33)	1,130	4.63 (2.1)	19.72" (501)	1.08" (27.35)	1/2" 	1.50" (38)
QE6ST033F61S06	2.4 – 24 (3.3 – 33)	1,130	4.85 (2.2)	21.42" (544)	1.08" (27.35)	3/8" 	1.50" (38)
QE6ST033F61S08	2.4 – 24 (3.3 – 33)	1,130	4.85 (2.2)	21.42" (544)	1.08" (27.35)	1/2" 	1.50" (38)
QE6ST033F81S06	2.4 – 24 (3.3 – 33)	1,130	5.07 (2.3)	23.39" (594)	1.08" (27.35)	3/8" 	1.50" (38)
QE6ST033F81S08	2.4 – 24 (3.3 – 33)	1,130	5.07 (2.3)	23.39" (594)	1.08" (27.35)	1/2" 	1.50" (38)
QE6ST050F41S08	3.7 – 36.75 (5.0 – 50)	760	4.63 (2.1)	19.72" (501)	1.08" (27.35)	1/2" 	1.50" (38)
QE6ST050F61S08	3.7 – 36.75 (5.0 – 50)	760	4.85 (2.2)	21.42" (544)	1.08" (27.35)	1/2" 	1.50" (38)
QE6ST050F81S08	3.7 – 36.75 (5.0 – 50)	760	5.07 (2.3)	21.42" (544)	1.08" (27.35)	1/2" 	1.50" (38)

Manuals:

-  16574477
-  04580973
-  16576951
-  16575177

							
Model	ft-lbs (Nm)	rpm	lbs (kg)	in (mm)	in (mm)	in	in (mm)
CC QE8 INLINE							
QE8ST055F41S08	4 – 40 (5.5 – 55)	1,470	6.61 (3)	21.97" (558)	1.19" (30.25)	1/2" 	1.50" (38)
QE8ST055F61S08	4 – 40 (5.5 – 55)	1,470	6.61 (3)	23.94" (608)	1.19" (30.25)	1/2" 	1.50" (38)
QE8ST055F81S08	4 – 40 (5.5 – 55)	1,470	6.61 (3)	25.95" (659)	1.19" (30.25)	1/2" 	1.50" (38)
QE8ST070F41S08	5.1 – 51 (7.0 – 70)	1,160	6.61 (3)	21.97" (558)	1.19" (30.25)	1/2" 	1.50" (38)
QE8ST070F61S08	5.1 – 51 (7.0 – 70)	1,160	6.61 (3)	23.94" (608)	1.19" (30.25)	1/2" 	1.50" (38)
QE8ST070F81S08	5.1 – 51 (7.0 – 70)	1,160	6.61 (3)	25.95" (659)	1.19" (30.25)	1/2" 	1.50" (38)
QE8ST090F41S08	6.6 – 66 (9.0 – 90)	900	6.61 (3)	21.97" (558)	1.19" (30.25)	1/2" 	1.50" (38)
QE8ST090F61S08	6.6 – 66 (9.0 – 90)	900	6.61 (3)	23.94" (608)	1.19" (30.25)	1/2" 	1.50" (38)
QE8ST090F81S08	6.6 – 66 (9.0 – 90)	900	6.61 (3)	25.95" (659)	1.19" (30.25)	1/2" 	1.50" (38)
QE8ST150F41S08	11 – 110 (15 – 150)	500	7.5 (3.4)	23.31" (592)	1.20" (30.55)	1/2" 	1.50" (38)
QE8ST150F61S08	11 – 110 (15 – 150)	500	7.5 (3.4)	25.32" (643)	1.20" (30.55)	1/2" 	1.50" (38)
QE8ST150F81S08	11 – 110 (15 – 150)	500	7.5 (3.4)	27.33" (694)	1.20" (30.55)	1/2" 	1.50" (38)
QE8ST230F62S12	17 – 169 (23 – 230)	340	12.13 (5.5)	28.23" (717)	1.43" (36.20)	3/4" 	1.97" (50)
QE8ST230F82S12	17 – 169 (23 – 230)	340	12.13 (5.5)	30.24" (768)	1.43" (36.20)	3/4" 	1.97" (50)
QE8ST230F02S12	17 – 169 (23 – 230)	340	12.13 (5.5)	32.25" (819)	1.43" (36.20)	3/4" 	1.97" (50)
QE8ST230F22S12	17 – 169 (23 – 230)	340	12.13 (5.5)	34.25" (870)	1.43" (36.20)	3/4" 	1.97" (50)

DC Electric Nutrunners

Inline Offset

QE Series Inline Offsets

Delivers all the benefits of the standard QE Series Inline tool, and satisfies tight clearance requirements with an integral offset spindle. Non-contacting switches, heavy-duty gear train, and DC brushless motor create a durable package that will keep the line running smoothly and maintenance costs down.



QE6ZC020P52S06

Features

- Torque Range: 1.5 – 110 ft-lbs (2.0 – 150 Nm)
- Speeds: Adjustable to 1,840 rpm
- True closed-loop transducerized control provides exceptional accuracy
- Advanced tightening strategies and data and process communications
- Compact, high-speed, easily accessible controls
- Bright LEDs provide visible status indicators
- High-temperature motor protection
- Preventive maintenance alerts

Service and Accessories

Factory Direct Options for QE6 and QE8

Activation: Fifth Digit QE8Z()
T = Trigger
L = Lever
E = Extended Lever
C = Machine Start

Manuals:

- 16574469
- (Offset) P7780
- 16576951
- 16575169

Accessories:







Torque tubes, see page 182
 Cables, see page 47
 Smart socket trays, see page 48
 Socket pins, see page 48
 ICD & M controllers, see page 39













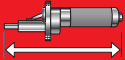

















Model	ft-lbs (Nm)	rpm	lbs (kg)	in (mm)	in (mm)	in	in (mm)
DC QE6 OFFSET							
QE6ZC020P42S06	1.5 – 14.7 (2 – 20)	1,840	5.51 (2.5)	26.14" (664)	0.69" (17.5)	3/8"	1.97" (50)
QE6ZC020P52S06	1.5 – 14.7 (2 – 20)	1,840	5.51 (2.5)	25.47" (647)	0.69" (17.5)	3/8"	1.97" (50)
QE6ZC028P52S06	2.0 – 20 (3 – 28)	1,360	5.51 (2.5)	25.47" (647)	0.69" (17.5)	3/8"	1.97" (50)
QE6ZC033P52S06	2.4 – 24 (3.3 – 33)	1,130	5.51 (2.5)	25.47" (647)	0.69" (17.5)	3/8"	1.97" (50)
QE6ZC050P52S06	3.7 – 36.75 (5 – 50)	760	5.51 (2.5)	25.47" (647)	0.69" (17.5)	3/8"	1.97" (50)

DC Electric Nutrunners

Offset

Manuals:

-  16574477
-  (Offset) P7781
-  (Hi-Torque) 04580973
-  16576951
-  (Offset 055) P7780
-  16575177

							
Model	ft-lbs (Nm)	rpm	lbs (kg)	in (mm)	in (mm)	in	in (mm)
DC QE8 OFFSET							
QE8ZC055F52S06	4 – 40 (5.5 – 55)	1,470	6.61 (3.0)	28.46" (723)	0.69" (17.5)	3/8" 	1.97" (50)
QE8ZC070F02S08	5.2 – 52 (7 – 70)	1,470	6.61 (3.0)	34.96" (888)	0.88" (22.35)	1/2" 	1.97" (50)
QE8ZC070F02S12	5.2 – 52 (7 – 70)	1,470	6.61 (3.0)	34.96" (888)	0.88" (22.35)	3/4" 	1.97" (50)
QE8ZC070F22S08	5.2 – 52 (7 – 70)	1,470	6.61 (3.0)	36.97" (939)	0.88" (22.35)	1/2" 	1.97" (50)
QE8ZC070F22S12	5.2 – 52 (7 – 70)	1,470	6.61 (3.0)	36.97" (939)	0.88" (22.35)	3/4" 	1.97" (50)
QE8ZC070F62S08	5.2 – 52 (7 – 70)	1,470	6.61 (3.0)	30.94" (786)	0.88" (22.35)	1/2" 	1.97" (50)
QE8ZC070F62S12	5.2 – 52 (7 – 70)	1,470	6.61 (3.0)	30.94" (786)	0.88" (22.35)	3/4" 	1.97" (50)
QE8ZC070F82S08	4 – 40 (5.5 – 55)	1,470	6.61 (3.0)	32.95" (837)	0.88" (22.35)	1/2" 	1.97" (50)
QE8ZC070F82S12	4 – 40 (5.5 – 55)	1,470	6.61 (3.0)	32.95" (837)	0.88" (22.35)	3/4" 	1.97" (50)
QE8ZC090F02S08	6.6 – 66 (9.0 – 90)	900	8.82 (4.0)	34.96" (888)	0.88" (22.35)	1/2" 	1.97" (50)
QE8ZC090F02S12	6.6 – 66 (9.0 – 90)	900	8.82 (4.0)	34.96" (888)	0.88" (22.35)	3/4" 	1.97" (50)
QE8ZC090F22S08	6.6 – 66 (9.0 – 90)	900	8.82 (4.0)	36.97" (939)	0.88" (22.35)	1/2" 	1.97" (50)
QE8ZC090F22S12	6.6 – 66 (9.0 – 90)	900	8.82 (4.0)	36.97" (939)	0.88" (22.35)	3/4" 	1.97" (50)
QE8ZC090F62S08	6.6 – 66 (9.0 – 90)	900	8.82 (4.0)	30.94" (786)	0.88" (22.35)	1/2" 	1.97" (50)
QE8ZC090F62S12	6.6 – 66 (9.0 – 90)	900	8.82 (4.0)	30.94" (786)	0.88" (22.35)	3/4" 	1.97" (50)
QE8ZC090F82S08	6.6 – 66 (9.0 – 90)	900	8.82 (4.0)	32.95" (837)	0.88" (22.35)	1/2" 	1.97" (50)
QE8ZC090F82S12	6.6 – 66 (9.0 – 90)	900	8.82 (4.0)	32.95" (837)	0.88" (22.35)	3/4" 	1.97" (50)
QE8ZC150F02S08	11 – 110 (15 – 150)	500	8.82 (4.0)	34.96" (888)	0.88" (22.35)	1/2" 	1.97" (50)
QE8ZC150F02S12	11 – 110 (15 – 150)	500	8.82 (4.0)	34.96" (888)	0.88" (22.35)	3/4" 	1.97" (50)
QE8ZC150F22S08	11 – 110 (15 – 150)	500	8.82 (4.0)	36.97" (939)	0.88" (22.35)	1/2" 	1.97" (50)
QE8ZC150F22S12	11 – 110 (15 – 150)	500	8.82 (4.0)	36.97" (939)	0.88" (22.35)	3/4" 	1.97" (50)
QE8ZC150F62S08	11 – 110 (15 – 150)	500	8.82 (4.0)	30.94" (786)	0.88" (22.35)	1/2" 	1.97" (50)
QE8ZC150F62S12	11 – 110 (15 – 150)	500	8.82 (4.0)	30.94" (786)	0.88" (22.35)	3/4" 	1.97" (50)
QE8ZC150F82S08	11 – 110 (15 – 150)	500	8.82 (4.0)	32.95" (837)	0.88" (22.35)	1/2" 	1.97" (50)
QE8ZC150F82S12	11 – 110 (15 – 150)	500	8.82 (4.0)	32.95" (837)	0.88" (22.35)	3/4" 	1.97" (50)

DC Electric Nutrunners

Angle

QE Series Angles

A proven world-class combination — QE tools and IC Series controllers team up to provide superior accuracy and durability and meet your critical fastening requirements. The non-contacting switches, heavy-duty gear train, and DC brushless motor create a durable package, while the compact, ergonomic design and easily accessible controls help operators keep production lines running smoothly.



QE4AT020PA2S06

Features

- Torque Range: 1 – 294 ft-lbs (1.3 – 400 Nm)
- Speeds: Adjustable to 1230 rpm
- True closed-loop transducerized control provides exceptional accuracy
- Advanced tightening strategies and data and process communications
- TactAlert provides positive feedback to the operator without distracting from the task
- Compact, high-speed, easily accessible controls
- Easy-to-use reverse ring
- Bright LEDs provide visible status indicators
- Comfortable ergonomic grip
- High-temperature motor protection
- Preventive maintenance alerts

Service and Accessories

Factory Direct Options for QE4, QE6 and QE8

Activation: Fifth Digit QE8A()
T = Trigger
L = Lever
E = Extended Lever
C = Machine Start

Mounting: Ninth Digit QE8AT150()
P = No Mount*
F = Flanged Mount**
R = Reaction Bar Kit*
B = Flange Mount Kit*
J = Two-Piece Mounting Plate

* Not available on 225 or 400 Nm tools

** Not available on QE4

Manuals:



- 16574451
- 16576951
- 16574451

Accessories:





Torque arms, see page 180
 Torque tubes, see page 182
 Cables, see page 47
 Swivel hangers, see page 47
 Suspension bails, see page 47
 Smart socket trays, see page 48
 Quick-change socket pins, see page 48
 Mounting flanges, see page 47
 Extended lever, see page 47
 ICD & M controllers, see page 39

Model	ft-lbs (Nm)	rpm	lbs (kg)	in (mm)	in (mm)	in
DC QE4 ANGLE						
QE4AT013PA2H04	1 – 9.5 (1.3 – 13)	1,200	2.87 (1.3)	15.08" (383)	0.51" (12.9)	1/4"
QE4AT013PA2Q04	1 – 9.5 (1.3 – 13)	1,200	2.87 (1.3)	15.08" (383)	0.51" (12.9)	1/4"
QE4AT013PA2S04	1 – 9.5 (1.3 – 13)	1,200	2.87 (1.3)	15.08" (383)	0.51" (12.9)	1/4"
QE4AT013PA2S06	1 – 9.5 (1.3 – 13)	1,200	2.87 (1.3)	15.08" (383)	0.51" (12.9)	3/8"
QE4AT020PA2H04	1.5 – 14.7 (2 – 20)	820	2.87 (1.3)	15.08" (383)	0.51" (12.9)	1/4"
QE4AT020PA2Q04	1.5 – 14.7 (2 – 20)	820	2.87 (1.3)	15.08" (383)	0.51" (12.9)	1/4"
QE4AT020PA2S04	1.5 – 14.7 (2 – 20)	820	2.87 (1.3)	15.08" (383)	0.51" (12.9)	1/4"
QE4AT020PA2S06	1.5 – 14.7 (2 – 20)	820	2.87 (1.3)	15.08" (383)	0.51" (12.9)	3/8"
QE4AT027PA4S06	2 – 19.8 (2.7 – 27)	600	2.87 (1.3)	15.24" (387)	0.67" (17.0)	3/8"
QE4AT027PA4S08	2 – 19.8 (2.7 – 27)	600	2.87 (1.3)	15.24" (387)	0.67" (17.0)	1/2"
QE4AT034PA4S06	2.5 – 25 (3.4 – 34)	470	2.87 (1.3)	15.24" (387)	0.67" (17.0)	3/8"
QE4AT034PA4S08	2.5 – 25 (3.4 – 34)	470	2.87 (1.3)	15.24" (387)	0.67" (17.0)	1/2"

Manuals:

































-  16574469
-  16576951
-  16575169

QE6 Series

-  16574477
-  04580973
-  16576951
-  16575177

QE8 Series



						
Model	ft-lbs (Nm)	rpm	lbs (kg)	in (mm)	in (mm)	in
DC QE6 ANGLE						
QE6AT030PA2S06	2.2 – 22 (3 – 30)	1,230	4.19 (1.9)	17.40" (442)	0.50" (12.8)	3/8" 
QE6AT030PA4S06	2.2 – 22 (3 – 30)	1,230	4.19 (1.9)	17.60" (447)	0.67" (17.0)	3/8" 
QE6AT030PA4S08	2.2 – 22 (3 – 30)	1,230	4.19 (1.9)	17.60" (447)	0.67" (17.0)	1/2" 
QE6AT040PA4S06	3 – 29.4 (4 – 40)	910	4.19 (1.9)	17.60" (447)	0.67" (17.0)	3/8" 
QE6AT040PA4S08	3 – 29.4 (4 – 40)	910	4.19 (1.9)	17.60" (447)	0.67" (17.0)	1/2" 
QE6AT055PA5S08	4 – 40 (5.5 – 55)	650	4.41 (2.0)	17.80" (452)	0.84" (21.4)	1/2" 
QE6AT080PA5S08	5.9 – 58.8 (8 – 80)	440	4.41 (2.0)	17.80" (452)	0.84" (21.4)	1/2" 
DC QE8 ANGLE						
QE8AT065FA5S08	4.8 – 47.8 (6.5 – 65)	1,200	6.39 (2.9)	20.28" (515)	0.84" (21.4)	1/2" 
QE8AT065PA5S08	4.8 – 47.8 (6.5 – 65)	1,200	6.39 (2.9)	20.28" (515)	0.84" (21.4)	1/2" 
QE8AT065FA6S08	4.8 – 47.8 (6.5 – 65)	1,200	6.61 (3.0)	20.47" (520)	0.96" (24.3)	1/2" 
QE8AT065PA6S08	4.8 – 47.8 (6.5 – 65)	1,200	6.61 (3.0)	20.47" (520)	0.96" (24.3)	1/2" 
QE8AT070FA5S08	5.1 – 51 (7.0 – 70)	1,100	6.39 (2.9)	20.28" (515)	0.84" (21.4)	1/2" 
QE8AT070PA5S08	5.1 – 51 (7.0 – 70)	1,100	6.39 (2.9)	20.28" (515)	0.84" (21.4)	1/2" 
QE8AT070FA6S08	5.1 – 51 (7.0 – 70)	1,100	6.61 (3.0)	20.47" (520)	0.96" (24.3)	1/2" 
QE8AT070PA6S08	5.1 – 51 (7.0 – 70)	1,100	6.61 (3.0)	20.47" (520)	0.96" (24.3)	1/2" 
QE8AT090FA5S08	6.6 – 66 (9.0 – 90)	850	6.39 (2.9)	20.28" (515)	0.84" (21.4)	1/2" 
QE8AT090PA5S08	6.6 – 66 (9.0 – 90)	850	6.39 (2.9)	20.28" (515)	0.84" (21.4)	1/2" 
QE8AT090FA6S08	6.6 – 66 (9.0 – 90)	850	6.61 (3.0)	20.47" (520)	0.96" (24.3)	1/2" 
QE8AT090PA6S08	6.6 – 66 (9.0 – 90)	850	6.61 (3.0)	20.47" (520)	0.96" (24.3)	1/2" 
QE8AT115FA6S08	8.5 – 84.5 (11.5 – 115)	660	6.61 (3.0)	20.47" (520)	0.96" (24.3)	1/2" 
QE8AT115PA6S08	8.5 – 84.5 (11.5 – 115)	660	6.61 (3.0)	20.47" (520)	0.96" (24.3)	1/2" 
QE8AT150FA6S08	11 – 110 (15 – 150)	510	6.83 (3.1)	20.47" (520)	0.96" (24.3)	1/2" 
QE8AT150PA6S08	11 – 110 (15 – 150)	510	6.83 (3.1)	20.47" (520)	0.96" (24.3)	1/2" 
QE8AT225FA7S12	16.5 – 165 (22.5 – 225)	310	9.04 (4.1)	22.68" (576)	1.19" (30.15)	3/4" 
QE8AT225PA7S12	16.5 – 165 (22.5 – 225)	310	9.04 (4.1)	22.68" (576)	1.19" (30.15)	3/4" 
QE8AT400FA8S12	29 – 294 (40 – 400)	170	13.23 (6.0)	25.08" (637)	1.40" (35.6)	3/4" 

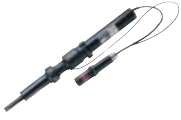

DC Electric Fixtured Spindles

Torque Selection Guide

Inline

Model	0	20 Nm	40 Nm	60 Nm	80 Nm	100 Nm	250 Nm	500 Nm	1000 Nm	1500 Nm	2000 Nm	2500 Nm	Referral page
QM3SS008...													31
QM3SS012...													31
QM3SS016...													31
QM3SS020...													31
QM5SS035...													32
QM5SS055...													32
QM5SS090...													32
QM7SS190...													32
QM7SS220...													32
QM9SS315...													33
QM9SS435...													33
QM9SS520...													33
QM9SS650...													33
QM9SS01K...													33
QM9SS15C...													33
QM9SS18C...													33
QM9SS20C...													33
QM9SS22C...													33

Inline Offset

Model	0	50 Nm	100 Nm	150 Nm	200 Nm	250 Nm	300 Nm	350 Nm	400 Nm	450 Nm	Referral page	
QM5ZS035...												34
QM5ZS050...												34
QM7ZS150...												34
QM9ZS315...												35
QM9ZS435...												35
QM9ZS450...												35

DC Electric Fixtured Spindles

QM Series Inline

Heavy-duty motors offer high accuracy and control over your fastening application. Whether used in single spindle or multiple spindle configurations, these world-class tools provide top-quality performance and long life.



QM3SS008H...

Features

- Torque range: 0.59 – 1617 ft-lbs (0.8 – 2200 Nm)
- Speeds: Adjustable to 1382 rpm
- Better than 5 percent capability
- High-duty cycle motors and components provide excellent durability
- External electronics pod simplifies integration
- Available with or without spindles in a variety of length and drive options

Body style specified in fourth digit: ex, QM3()S008H62S06
S = Motor with spindle, **M** = Motor without spindle

Spindle spring tension specified in ninth digit: ex, QM3SS008()62S06
H = Heavy spring, **L** = Light spring, **S** = Solid, non-floating

Standard spindle float is 2" (50 mm)

Models specified in the table below have spindles with heavy spindle springs



Manuals:

- 04581310
- 04581278
- 04581351



Model	ft-lbs (Nm)	rpm	lbs (kg)	in (mm)	in (mm)	in	in (mm)
DC QM3 INLINE							
QM3SS008H62S06	0.59 – 5.9 (0.8 – 8)	1382	5.3 (2.4)	17.7" (449)	0.67" (17.0)	3/8" □	6" (150)
QM3SS008H62S08	0.59 – 5.9 (0.8 – 8)	1382	5.3 (2.4)	17.7" (449)	0.67" (17.0)	1/2" □	6" (150)
QM3SS008H92S06	0.59 – 5.9 (0.8 – 8)	1382	5.6 (2.4)	20.6" (524)	0.67" (17.0)	3/8" □	9" (225)
QM3SS008H92S08	0.59 – 5.9 (0.8 – 8)	1382	5.6 (2.4)	20.6" (524)	0.67" (17.0)	1/2" □	9" (225)
QM3SS008H22S06	0.59 – 5.9 (0.8 – 8)	1382	5.9 (2.7)	23.6" (599)	0.67" (17.0)	3/8" □	12" (300)
QM3SS008H22S08	0.59 – 5.9 (0.8 – 8)	1382	5.9 (2.7)	23.6" (599)	0.67" (17.0)	1/2" □	12" (300)
QM3SS012H62S06	0.9 – 8.8 (1.2 – 12)	927	5.3 (2.4)	17.7" (449)	0.67" (17.0)	3/8" □	6" (150)
QM3SS012H62S08	0.9 – 8.8 (1.2 – 12)	927	5.3 (2.4)	17.7" (449)	0.67" (17.0)	1/2" □	6" (150)
QM3SS012H92S06	0.9 – 8.8 (1.2 – 12)	927	5.6 (2.5)	20.6" (524)	0.67" (17.0)	3/8" □	9" (225)
QM3SS012H92S08	0.9 – 8.8 (1.2 – 12)	927	5.6 (2.5)	20.6" (524)	0.67" (17.0)	1/2" □	9" (225)
QM3SS012H22S06	0.9 – 8.8 (1.2 – 12)	927	5.9 (2.7)	23.6" (599)	0.67" (17.0)	3/8" □	12" (300)
QM3SS012H22S08	0.9 – 8.8 (1.2 – 12)	927	5.9 (2.7)	23.6" (599)	0.67" (17.0)	1/2" □	12" (300)
QM3SS016H62S06	1.2 – 11.7 (1.6 – 16)	686	5.3 (2.4)	17.7" (449)	0.67" (17.0)	3/8" □	6" (150)
QM3SS016H62S08	1.2 – 11.7 (1.6 – 16)	686	5.3 (2.4)	17.7" (449)	0.67" (17.0)	1/2" □	6" (150)
QM3SS016H92S06	1.2 – 11.7 (1.6 – 16)	686	5.6 (2.5)	20.6" (524)	0.67" (17.0)	3/8" □	9" (225)
QM3SS016H92S08	1.2 – 11.7 (1.6 – 16)	686	5.6 (2.5)	20.6" (524)	0.67" (17.0)	1/2" □	9" (225)
QM3SS016H22S06	1.2 – 11.7 (1.6 – 16)	686	5.9 (2.7)	23.6" (599)	0.67" (17.0)	3/8" □	12" (300)
QM3SS016H22S08	1.2 – 11.7 (1.6 – 16)	686	5.9 (2.7)	23.6" (599)	0.67" (17.0)	1/2" □	12" (300)
QM3SS020H62S06	1.5 – 14.7 (2 – 20)	545	5.3 (2.4)	17.7" (449)	0.67" (17.0)	3/8" □	6" (150)
QM3SS020H62S08	1.5 – 14.7 (2 – 20)	545	5.3 (2.4)	17.7" (449)	0.67" (17.0)	1/2" □	6" (150)
QM3SS020H92S06	1.5 – 14.7 (2 – 20)	545	5.6 (2.5)	20.6" (524)	0.67" (17.0)	3/8" □	9" (225)
QM3SS020H92S08	1.5 – 14.7 (2 – 20)	545	5.6 (2.5)	20.6" (524)	0.67" (17.0)	1/2" □	9" (225)
QM3SS020H22S06	1.5 – 14.7 (2 – 20)	545	5.9 (2.7)	23.6" (599)	0.67" (17.0)	3/8" □	12" (300)
QM3SS020H22S08	1.5 – 14.7 (2 – 20)	545	5.9 (2.7)	23.6" (599)	0.67" (17.0)	1/2" □	12" (300)

DC Electric Fixtured Spindles

Manuals:































-  04581328 QM5 Series
-  04581278
-  04581369

Manuals:



-  04581336 QM7 Series
-  04581278
-  04581377



QM7SS190H...



































							
Model	ft-lbs (Nm)	rpm	lbs (kg)	in (mm)	in (mm)	in	in (mm)
DC QM5 INLINE							
QM5SS035H62S06	2.6 – 25.7 (3.5 – 35)	590	8.6 (3.91)	20.6" (523)	0.87" (22)	3/8" 	6" (150)
QM5SS035H62S08	2.6 – 25.7 (3.5 – 35)	590	8.6 (3.91)	20.6" (523)	0.87" (22)	1/2" 	6" (150)
QM5SS035H92S06	2.6 – 25.7 (3.5 – 35)	590	8.9 (4.05)	23.5" (598)	0.87" (22)	3/8" 	9" (225)
QM5SS035H92S08	2.6 – 25.7 (3.5 – 35)	590	8.9 (4.05)	23.5" (598)	0.87" (22)	1/2" 	9" (225)
QM5SS035H22S06	2.6 – 25.7 (3.5 – 35)	590	9.2 (4.19)	26.5" (673)	0.87" (22)	3/8" 	12" (300)
QM5SS035H22S08	2.6 – 25.7 (3.5 – 35)	590	9.2 (4.19)	26.5" (673)	0.87" (22)	1/2" 	12" (300)
QM5SS055H62S06	4.1 – 40.4 (5.5 – 55)	507	8.6 (3.91)	20.6" (523)	0.87" (22)	3/8" 	6" (150)
QM5SS055H62S08	4.1 – 40.4 (5.5 – 55)	507	8.6 (3.91)	20.6" (523)	0.87" (22)	1/2" 	6" (150)
QM5SS055H92S06	4.1 – 40.4 (5.5 – 55)	507	8.9 (4.05)	23.5" (598)	0.87" (22)	3/8" 	9" (225)
QM5SS055H92S08	4.1 – 40.4 (5.5 – 55)	507	8.9 (4.05)	23.5" (598)	0.87" (22)	1/2" 	9" (225)
QM5SS055H22S06	4.1 – 40.4 (5.5 – 55)	507	9.2 (4.19)	26.5" (673)	0.87" (22)	3/8" 	12" (300)
QM5SS055H22S08	4.1 – 40.4 (5.5 – 55)	507	9.2 (4.19)	26.5" (673)	0.87" (22)	1/2" 	12" (300)
QM5SS090H62S08	6.6 – 66 (9 – 90)	280	8.9 (4.05)	20.6" (523)	0.87" (22)	1/2" 	6" (150)
QM5SS090H92S08	6.6 – 66 (9 – 90)	280	9.2 (4.19)	23.5" (598)	0.87" (22)	1/2" 	9" (225)
QM5SS090H22S08	6.6 – 66 (9 – 90)	280	8.6 (3.91)	26.5" (673)	0.87" (22)	1/2" 	12" (300)
DC QM7 INLINE							
QM7SS190H62S08	14 – 139 (19 – 190)	273	18.5 (8.4)	25.4" (645)	1.38" (35)	1/2" 	6" (150)
QM7SS190H62S12	14 – 139 (19 – 190)	273	18.5 (8.4)	25.4" (645)	1.38" (35)	3/4" 	6" (150)
QM7SS190H92S08	14 – 139 (19 – 190)	273	19.0 (8.63)	28.3" (720)	1.38" (35)	1/2" 	9" (225)
QM7SS190H92S12	14 – 139 (19 – 190)	273	19.1 (8.67)	28.3" (720)	1.38" (35)	3/4" 	9" (225)
QM7SS190H22S08	14 – 139 (19 – 190)	273	19.5 (8.85)	31.3" (794)	1.38" (35)	1/2" 	12" (300)
QM7SS190H22S12	14 – 139 (19 – 190)	273	19.6 (8.89)	31.3" (794)	1.38" (35)	3/4" 	12" (300)
QM7SS220H62S12	16.2 – 161 (22 – 220)	233	18.5 (8.4)	25.4" (645)	1.38" (35)	3/4" 	6" (150)
QM7SS220H92S12	16.2 – 161 (22 – 220)	233	19.1 (8.67)	28.3" (720)	1.38" (35)	3/4" 	9" (225)
QM7SS220H22S12	16.2 – 161 (22 – 220)	233	19.6 (8.89)	31.3" (794)	1.38" (35)	3/4" 	12" (300)

Manuals:

-  04581344
-  04581278
-  04581385



QM9SS520H...

							
Model	ft-lbs (Nm)	rpm	lbs (kg)	in (mm)	in (mm)	in	in (mm)
DC QM9 INLINE							
QM9SS315H62S12	24 – 231 (31.5 – 315)	278	41.0 (18.6)	28.0" (711)	1.75" (44.5)	3/4" 	6" (150)
QM9SS315H62S16	24 – 231 (31.5 – 315)	278	41.2 (18.67)	30.9" (786)	1.75" (44.5)	1" 	6" (150)
QM9SS315H92S12	24 – 231 (31.5 – 315)	278	42.1 (19.1)	33.9" (860)	1.75" (44.5)	3/4" 	9" (225)
QM9SS315H92S16	24 – 231 (31.5 – 315)	278	42.3 (19.18)	28.0" (711)	1.75" (44.5)	1" 	9" (225)
QM9SS315H22S12	24 – 231 (31.5 – 315)	278	43.0 (19.52)	30.9" (786)	1.75" (44.5)	3/4" 	12" (300)
QM9SS315H22S16	24 – 231 (31.5 – 315)	278	43.2 (19.61)	33.9" (860)	1.75" (44.5)	1" 	12" (300)
QM9SS435H62S12	32 – 319 (43.5 – 435)	203	41.0 (18.6)	28.0" (711)	1.75" (44.5)	3/4" 	6" (150)
QM9SS435H62S16	32 – 319 (43.5 – 435)	203	41.2 (18.67)	30.9" (786)	1.75" (44.5)	1" 	6" (150)
QM9SS435H92S12	32 – 319 (43.5 – 435)	203	42.1 (19.1)	33.9" (860)	1.75" (44.5)	3/4" 	9" (225)
QM9SS435H92S16	32 – 319 (43.5 – 435)	203	42.3 (19.18)	28.0" (711)	1.75" (44.5)	1" 	9" (225)
QM9SS435H22S12	32 – 319 (43.5 – 435)	203	43.0 (19.52)	30.9" (786)	1.75" (44.5)	3/4" 	12" (300)
QM9SS435H22S16	32 – 319 (43.5 – 435)	203	43.2 (19.61)	33.9" (860)	1.75" (44.5)	1" 	12" (300)
QM9SS520H62S12	38 – 382 (52 – 520)	170	41.0 (18.6)	28.0" (711)	1.75" (44.5)	3/4" 	6" (150)
QM9SS520H62S16	38 – 382 (52 – 520)	170	41.2 (18.67)	30.9" (786)	1.75" (44.5)	1" 	6" (150)
QM9SS520H92S12	38 – 382 (52 – 520)	170	42.1 (19.1)	33.9" (860)	1.75" (44.5)	3/4" 	9" (225)
QM9SS520H92S16	38 – 382 (52 – 520)	170	42.3 (19.18)	28.0" (711)	1.75" (44.5)	1" 	9" (225)
QM9SS520H22S12	38 – 382 (52 – 520)	170	43.0 (19.52)	30.9" (786)	1.75" (44.5)	3/4" 	12" (300)
QM9SS520H22S16	38 – 382 (52 – 520)	170	43.2 (19.61)	33.9" (860)	1.75" (44.5)	1" 	12" (300)
QM9SS650H62S16	48 – 477 (65 – 650)	136	41.2 (18.67)	28.0" (711)	1.75" (44.5)	1" 	6" (150)
QM9SS650H92S16	48 – 477 (65 – 650)	136	42.3 (19.18)	30.9" (786)	1.75" (44.5)	1" 	9" (225)
QM9SS650H22S16	48 – 477 (65 – 650)	136	43.2 (19.61)	33.9" (860)	1.75" (44.5)	1" 	12" (300)
QM9SS01KH22S16	74 – 735 (100 – 1000)	51	54.0 (24.5)	33.7" (857)	2.55" (65)	1" 	6" (150)
QM9SS01KH62S16	74 – 735 (100 – 1000)	51	55.1 (25.0)	36.7" (932)	2.55" (65)	1" 	9" (225)
QM9SS01KH92S16	74 – 735 (100 – 1000)	51	56.0 (25.4)	39.6" (1006)	2.55" (65)	1" 	12" (300)
QM9SS15CH62S24	110 – 1100 (150 – 1500)	51	70.6 (32.0)	34.2" (869)	2.88" (73)	1-1/2" 	6" (150)
QM9SS18CH62S24	132 – 1323 (180 – 1800)	37	70.6 (32.0)	34.2" (869)	2.88" (73)	1-1/2" 	6" (150)
QM9SS20CH62S24	147 – 1470 (200 – 2000)	31	70.6 (32.0)	34.2" (869)	2.88" (73)	1-1/2" 	6" (150)
QM9SS22CH62S24	162 – 1617 (220 – 2200)	25	70.6 (32.0)	34.2" (869)	2.88" (73)	1-1/2" 	6" (150)

DC Electric Fixtured Spindles

QM Series Offset

Heavy-duty motors offer high accuracy and control in tight clearance applications. Whether used in single-spindle or multiple-spindle configurations, these world-class tools provide top-quality performance and long life.

Features

- Torque range: 2.6 – 330 ft-lbs (3.5 – 450 Nm)
- Speeds: Adjustable to 590 rpm
- Better than 5 percent capability
- High-duty-cycle motors and components provide excellent durability in tight clearance applications
- External electronics pod simplifies integration
- Available in a variety of length and drive options
- Transducer mounted after offset gearbox







Spindle spring tension specified in ninth digit: ex, QM3ZS008()62S06

H = Heavy spring, **L** = Light spring,
S = Solid, non-floating

Standard spindle float is 2" (50 mm)

Models specified in the table below have spindles with heavy spindle springs

Manuals:

-  04581328 QM5 Series
-  04581278
-  04581369
-  04581336 QM7 Series
-  04581278
-  04581377

























Model	ft-lbs (Nm)	rpm	lbs (kg)	in (mm)	in (mm)	in	in (mm)
DC QM5 OFFSET							
QM5ZS035H62S06	2.6 – 25.7 (3.5 – 35)	590	11.18 (5.07)	23" (591)	0.69" (17.5)	3/8" □	6" (150)
QM5ZS035H62S08	2.6 – 25.7 (3.5 – 35)	590	11.20 (5.08)	23" (591)	0.69" (17.5)	1/2" □	6" (150)
QM5ZS035H92S06	2.6 – 25.7 (3.5 – 35)	590	11.49 (5.21)	26" (666)	0.69" (17.5)	3/8" □	9" (225)
QM5ZS035H92S08	2.6 – 25.7 (3.5 – 35)	590	11.51 (5.22)	26" (666)	0.69" (17.5)	1/2" □	9" (225)
QM5ZS035H22S06	2.6 – 25.7 (3.5 – 35)	590	11.80 (5.35)	29" (741)	0.69" (17.5)	3/8" □	12" (300)
QM5ZS035H22S08	2.6 – 25.7 (3.5 – 35)	590	11.82 (5.36)	29" (741)	0.69" (17.5)	1/2" □	12" (300)
QM5ZS050H62S06	3.7 – 36.7 (5 – 50)	507	11.18 (5.07)	23" (591)	0.69" (17.5)	3/8" □	6" (150)
QM5ZS050H62S08	3.7 – 36.7 (5 – 50)	507	11.20 (5.08)	23" (591)	0.69" (17.5)	1/2" □	6" (150)
QM5ZS050H92S06	3.7 – 36.7 (5 – 50)	507	11.49 (5.21)	26" (666)	0.69" (17.5)	3/8" □	9" (225)
QM5ZS050H92S08	3.7 – 36.7 (5 – 50)	507	11.51 (5.22)	26" (666)	0.69" (17.5)	1/2" □	9" (225)
QM5ZS050H22S06	3.7 – 36.7 (5 – 50)	507	11.80 (5.35)	29" (741)	0.69" (17.5)	3/8" □	12" (300)
QM5ZS050H22S08	3.7 – 36.7 (5 – 50)	507	11.82 (5.36)	29" (741)	0.69" (17.5)	1/2" □	12" (300)
DC QM7 OFFSET							
QM7ZS150H62S08	11 – 110 (15 – 150)	273	25.58 (11.60)	29" (749)	0.87" (22.0)	3/8" □	6" (150)
QM7ZS150H92S08	11 – 110 (15 – 150)	273	26.02 (11.80)	32" (824)	0.87" (22.0)	3/8" □	9" (225)
QM7ZS150H22S08	11 – 110 (15 – 150)	273	26.56 (12.50)	35" (898)	0.87" (22.0)	3/8" □	12" (300)
QM7ZS150H62S12	11 – 110 (15 – 150)	273	25.67 (11.64)	29" (749)	0.87" (22.0)	1/2" □	6" (150)
QM7ZS150H92S12	11 – 110 (15 – 150)	273	26.17 (11.87)	32" (824)	0.87" (22.0)	1/2" □	9" (225)
QM7ZS150H22S12	11 – 110 (15 – 150)	273	26.66 (12.09)	35" (898)	0.87" (22.0)	1/2" □	12" (300)

Manuals:

 04581344

 04581278

 04581358

							
Model	ft-lbs (Nm)	rpm	lbs (kg)	in (mm)	in (mm)	in	in (mm)
QC QM9 OFFSET							
QM9ZS315H62S12	24 – 231 (31.5 – 315)	278	54.24 (24.6)	33" (831)	1.24" (31.5)	3/4" 	6" (150)
QM9ZS315H92S12	24 – 231 (31.5 – 315)	278	55.35 (25.1)	36" (906)	1.24" (31.5)	3/4" 	9" (225)
QM9ZS315H22S12	24 – 231 (31.5 – 315)	278	56.45 (25.6)	39" (980)	1.24" (31.5)	3/4" 	12" (300)
QM9ZS315H62S16	24 – 231 (31.5 – 315)	278	54.40 (24.7)	33" (831)	1.24" (31.5)	1" 	6" (150)
QM9ZS315H92S16	24 – 231 (31.5 – 315)	278	55.52 (25.2)	36" (906)	1.24" (31.5)	1" 	9" (225)
QM9ZS315H22S16	24 – 231 (31.5 – 315)	278	56.27 (25.5)	39" (980)	1.24" (31.5)	1" 	12" (300)
QM9ZS435H62S12	32 – 319 (43.5 – 435)	203	54.24 (24.6)	33" (831)	1.24" (31.5)	3/4" 	6" (150)
QM9ZS435H92S12	32 – 319 (43.5 – 435)	203	55.35 (25.1)	36" (906)	1.24" (31.5)	3/4" 	9" (225)
QM9ZS435H22S12	32 – 319 (43.5 – 435)	203	56.45 (25.6)	39" (980)	1.24" (31.5)	3/4" 	12" (300)
QM9ZS435H62S16	32 – 319 (43.5 – 435)	203	54.40 (24.7)	33" (831)	1.24" (31.5)	1" 	6" (150)
QM9ZS435H92S16	32 – 319 (43.5 – 435)	203	55.52 (25.2)	36" (906)	1.24" (31.5)	1" 	9" (225)
QM9ZS435H22S16	32 – 319 (43.5 – 435)	203	56.27 (25.5)	39" (980)	1.24" (31.5)	1" 	12" (300)
QM9ZS450H62S12	33 – 330 (45 – 450)	170	54.24 (24.6)	33" (831)	1.24" (31.5)	3/4" 	6" (150)
QM9ZS450H92S12	33 – 330 (45 – 450)	170	55.35 (25.1)	36" (906)	1.24" (31.5)	3/4" 	9" (225)
QM9ZS450H22S12	33 – 330 (45 – 450)	170	56.45 (25.6)	39" (980)	1.24" (31.5)	3/4" 	12" (300)
QM9ZS450H62S16	33 – 330 (45 – 450)	170	54.40 (24.7)	33" (831)	1.24" (31.5)	1" 	6" (150)
QM9ZS450H92S16	33 – 330 (45 – 450)	170	55.52 (25.2)	36" (906)	1.24" (31.5)	1" 	9" (225)
QM9ZS450H22S16	33 – 330 (45 – 450)	170	56.27 (25.5)	39" (980)	1.24" (31.5)	1" 	12" (300)

Fixtured Fastening Systems

Quick Multiples

Fixtures

Modular designs provide easy customization of open- or closed-frame vertical, horizontal, and horizontal rotating Quick Multiple fixtures for DC electric and air spindles.

Features

- Pre-engineered modular designs provide quick quoting, configuration, and delivery
- Systems combine world-class portfolio of tools, controllers, handling devices, and fixtures to deliver superior ergonomics, reduced cycle times, more even clamp loads, and exceptional durability
- Fully configurable interface and handle options for optimal ergonomics
- Up to six DC electric or air spindles per system
- Multiple suspension and torque reaction options include: balancers, torque tubes, articulating arms, jib cranes, or pneumatic suspensions

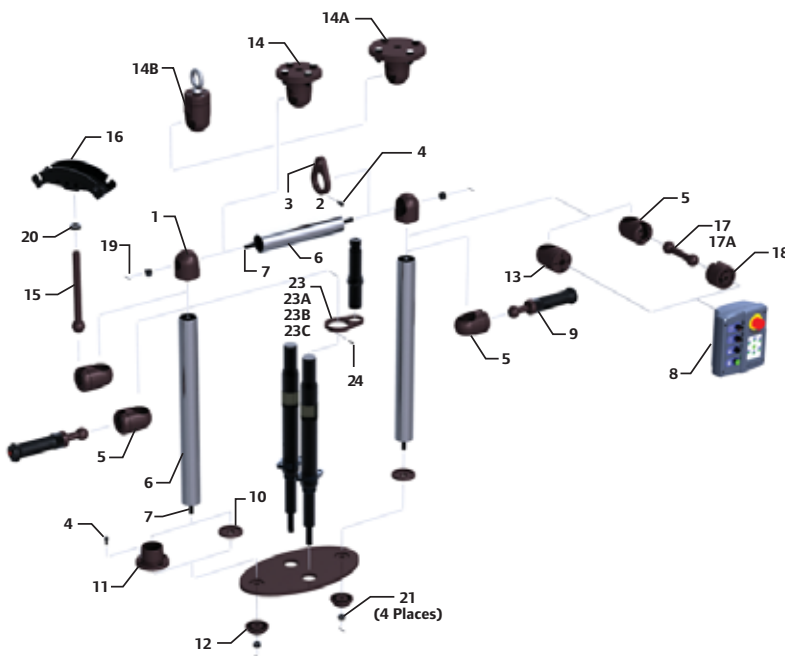

Item	Description	Part Number
QUICK MULTIPLE FIXTURES		
1	Tube elbow joint	QMM-712
2	Redundant eye assembly	QMM-A463
3	Redundant eye	QMM-463-2
4	Cap head screw (M6 x 1 x 6)	QMM-F1-638
5	Tube holder assembly	QMM-A30
6	Tube – standard 1 M	QMM-809-1M
7	Tie rod – standard 1 M	QMM-763-1M
8	Operator interface	(See page 38)
9	Handle	(See page 38)
10	Tube bracket vertical	QMMV-601
11	Tube bracket horizontal	QMM-601
12	Spherical washer	QMM-248
13	Interface mount assembly	QMML-A763
14	Suspension joint – 100 Nm	QMM-TA
14A	Suspension joint – 500 Nm	QMM-TAA
14B	Suspension joint – eye bolt	QMM-T
15	Ball end shaft	QMM-221-763
16	Cable tray	QMM-221
17	Ball to ball shaft – short	QMM-696-100
17A	Ball to ball shaft – long	QMM-696-200
18	Flat / tube holder assembly	QMM-A208
19	Cotter pin	QMM-15
20	Lock nut	QMM-582
21	Hex nut (M12 x 1.75)	QMM-H1-638
22	QMM warning label	QMM-99
22A	QMM branding label	QMM-301
23	POD mount bracket – tube	QMM-765-T
23A	POD mount bracket – QM9	QMM-765-9
23B	POD mount bracket – QM7	QMM-765-7
23C	POD mount bracket – QM5	QMM-765-5
24	Cap head screw (M3 x 0.5 x 16)	QMM-765-638
25	Retractable safety strap	QMM-298
26	Custom mounting plate	–



Service and Accessories

Manuals:

- 16607228
- 16607103

Accessories:

- QTA torque arms, see page 180
- Torque tubes, see form #MHD55226
- Balancers, see page 177
- Light tower, IC-LIGHT-TOWER
- Retractable safety strap, QMM-298
- Palm button reset, IC-PALM-RESET

Item	Description	Part Number
QUICK MULTIPLE FIXTURES		
31	Eye bolt (M12 x 1.75)	QMM-34
32	Plate holder assembly	QMM-A293
101	Corner spacer – 1 meter	QMM-93-1M
103	Back plate – small	QMMR-28C
103A	Back plate – large	QMMR-28
104	Back plate rib – small	QMMR-767C
104A	Back plate rib – large	QMMR-767
105	Back plate – small	QMMR-756C
105A	Back plate – large	QMMR-756
106	Suspension tube bracket	QMM-602
107	Circular handle – small	QMMR-A48C
107A	Circular handle – large	QMMR-A48
108	Suspension tube – 1 M	QMM-810-1M
109	Small bearing assembly	QMMR-A24C
109A	Large bearing assembly	QMMR-A24
110	Channel nut (M6)	QMMR-305
111	Button head screw (M6)	QMMR-638
112	Grip – circular handle – small	QMMR-144GC
112A	Grip – circular handle – large	QMMR-144G
113	Tube end cap	QMM-202
114	Suspension support	QMMR-766
116	Cap head screw (M8 x 1.25 x 25)	QMM-T6-638
117	Cap head screw (M10 x 1.5 x 25)	QMM-F8-638
119	Cap head screw (M10 x 1.5 x 35)	QMM-F10-638
231	Cap head screw (M8 x 1.25 x 20)	QMM-T63-638

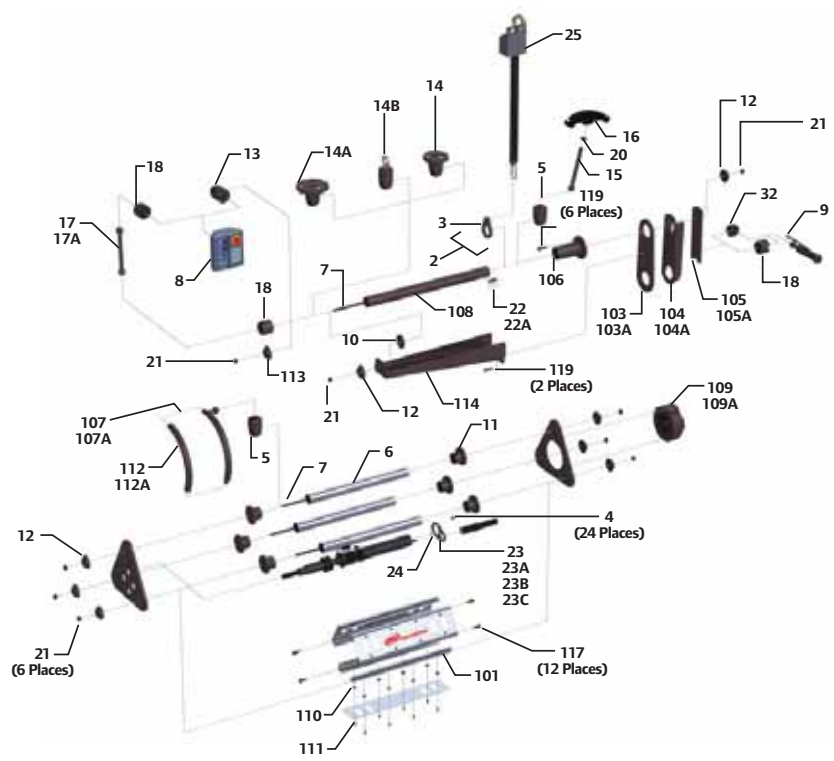

DC Electric Fixtured Fastening Systems

Multiples

Handle & Operator Interface

Modular designs provide optimal flexibility in selecting the exact operator interfaces that you need for your Fixtured Fastening Systems.

Features

- Designed to provide maximum flexibility: components can be panel, tube, or ball-joint mounted
- 18 handle configurations include options for trigger, slide switch, or pneumatic actuation with ball, flange or direct mount for optimal positioning
- Operator interface enclosures come standard with PCB, E-stop, whip cable, and configurable LED display that shows individual and master OK/NOK signals for up to six spindles, organized to match the bolt pattern. Four open positions provide space for selection from six interface options to enhance control and signaling

Service and Accessories

Kits:

Standard Interface, QMML-A424-KIT

Interface Options:

	Style 1 (Idec®)	Style 2 (Telemecanique®)
3-Position Switch	QMMC-75-1	QMMC-75-2
2-Position Switch	QMMC-76-1	QMMC-76-2
Push Button	QMMC-77-1	QMMC-77-2
Buzzer	QMMC-78-1	—
Red Pilot Light	QMMC-79-1	QMMC-79-2
Green Pilot Light	QMMC-80-1	QMMC-80-2
3-Position Key Switch	QMMC-81-1	QMMC-81-2

Manuals:

- 16607228
- 16607103



Accessories:

Handle extension cable, QMMC-46-2M
QMMC-46-4M, QMMC-46-6M
Interface extension cables, QMMC-A240-10,
QMMC-A240-20
Powerhead cable, QMMC-A240-2

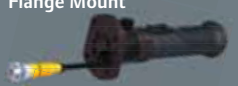
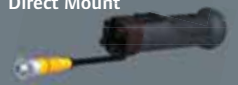
Configuration	Dead Handle	Trigger Only	Pneumatic Pendant	Slide Switch Only	Slide Switch Type	Slide Switch + Trigger	
						Aligned	Rotated
Ball Mount 	✓ QMMHB	✓ QMMHBT	✓ QMMH-A35	✓ QMMHBD QMMHBM	Detent Momentary	✓ QMMHBTDA QMMHBTMA	✓ QMMHBTDP QMMHBTMP
Flange Mount 	✓ QMMHF	✓ QMMHFT	✓ QMMH-A36	✓ QMMHFD QMMHFM	Detent Momentary	✓ QMMHFTDA QMMHFTMA	✓ QMMHFTDP QMMHFTMP
Direct Mount 	✓ QMMH	✓ QMMHT					

DC Electric Controllers



IC1D



IC1M

IC1D Controllers

The Ingersoll Rand IC1D Insight controllers give you full closed-loop control in a compact package. With features like a 1/4 VGA color display and easy, intuitive, quick set-up programming, the IC1D provides unmatched performance.

Standard Features

- 1/4 VGA color display (IC1D)
- Full keypad and navigation keys (IC1D)
- One-line LED Display (IC1M)
- Ethernet connection
- RS232
- Eight I/O
- 1000 cycle storage (IC1D)
- 200 cycle storage (IC1M)
- Eight instant configurations
- 256 stored configurations
- Dual power mode 120-240 V AC
- Quick set-up feature
- Small footprint (mm) 152h x 191w x 238d

Optional Features

- All units are available with the following options:
- 115 V AC power cord
 - 220 V AC power cord
 - 230 V AC EU pigtail power cord
 - Cabinet mount / wall mount
 - PFCS software package
 - Plus software package
 - 16 additional I/O
 - Fieldbus cards

Languages Available

- Chinese
- English
- French
- German
- Italian
- Russian
- Spanish

Service and Accessories

- Complete installation and repair service available
- Socket selector: IC-socket-4
- Light tower, see page 48
- Transfer key: 80150113
- Custom racks
- For additional accessories, see pages 47 – 48

Manuals:

04581732

IC Series DC Electric Controllers

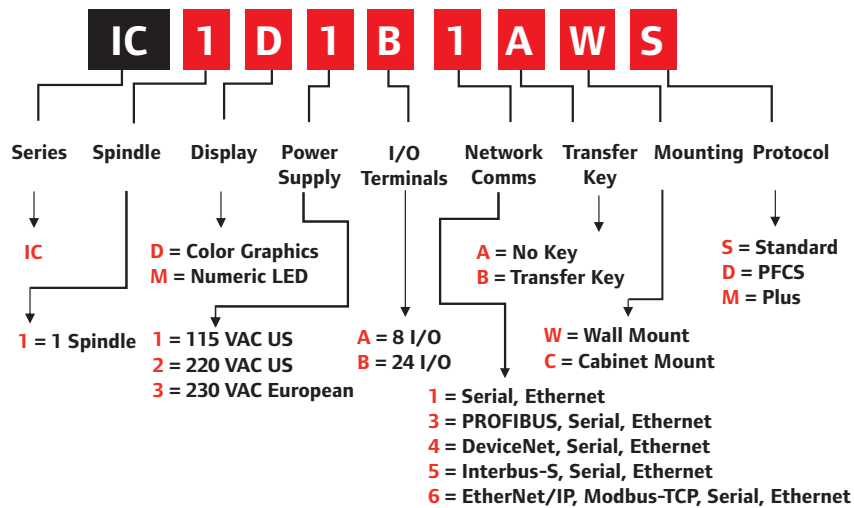

DC Electric Controllers

IC1D Model	IC1M Model	Power Cord	Number of Input / Outputs	Communication Package	Transfer Key
IC1D1A1AWS	IC1M1A1AWS	115 V AC USA	8	Ethernet and Serial	No
IC1D2A1AWS	IC1M2A1AWS	220 V AC USA	8	Ethernet and Serial	No
IC1D1A1BWS	IC1M1A1BWS	115 V AC USA	8	Ethernet and Serial	Yes
IC1D2A1BWS	IC1M2A1BWS	220 V AC USA	8	Ethernet and Serial	Yes
IC1D3A1BWS	IC1M2A1BWS	230 V AC Europe	8	Ethernet and Serial	Yes
IC1D1A3AWS	IC1M1A3AWS	115 V AC USA	8	PROFIBUS, Ethernet, and Serial	No
IC1D2A3AWS	IC1M2A3AWS	220 V AC USA	8	PROFIBUS, Ethernet, and Serial	No
IC1D1A3BWS	IC1M1A3BWS	115 V AC USA	8	PROFIBUS, Ethernet, and Serial	Yes
IC1D2A3BWS	IC1M2A3BWS	220 V AC USA	8	PROFIBUS, Ethernet, and Serial	Yes
IC1D3A3BWS	IC1M2A3BWS	230 V AC Europe	8	PROFIBUS, Ethernet, and Serial	Yes
IC1D1A4AWS	IC1M1A4AWS	115 V AC USA	8	DeviceNet, Ethernet, and Serial	No
IC1D2A4AWS	IC1M2A4AWS	220 V AC USA	8	DeviceNet, Ethernet, and Serial	No
IC1D1A4BWS	IC1M1A4BWS	115 V AC USA	8	DeviceNet, Ethernet, and Serial	Yes
IC1D2A4BWS	IC1M2A4BWS	220 V AC USA	8	DeviceNet, Ethernet, and Serial	Yes
IC1D3A4BWS	IC1M2A4BWS	230 V AC Europe	8	DeviceNet, Ethernet, and Serial	Yes
IC1D1A5AWS	IC1M1A5AWS	115 V AC USA	8	Interbus-S, Ethernet, and Serial	No
IC1D2A5AWS	IC1M2A5AWS	220 V AC USA	8	Interbus-S, Ethernet, and Serial	No
IC1D1A5BWS	IC1M1A5BWS	115 V AC USA	8	Interbus-S, Ethernet, and Serial	Yes
IC1D2A5BWS	IC1M2A5BWS	220 V AC USA	8	Interbus-S, Ethernet, and Serial	Yes
IC1D3A5BWS	IC1M2A5BWS	230 V AC Europe	8	Interbus-S, Ethernet, and Serial	Yes
IC1D1A6AWS	IC1M1A6AWS	115 V AC USA	8	EtherNet/IP, Modbus-TCP, Ethernet, and Serial	No
IC1D2A6AWS	IC1M2A6AWS	220 V AC USA	8	EtherNet/IP, Modbus-TCP, Ethernet, and Serial	No
IC1D1A6BWS	IC1M1A6BWS	115 V AC USA	8	EtherNet/IP, Modbus-TCP, Ethernet, and Serial	Yes
IC1D2A6BWS	IC1M2A6BWS	220 V AC USA	8	EtherNet/IP, Modbus-TCP, Ethernet, and Serial	Yes
IC1D3A6BWS	IC1M2A6BWS	230 V AC Europe	8	EtherNet/IP, Modbus-TCP, Ethernet, and Serial	Yes
IC1D1B1AWS	IC1M1B1AWS	115 V AC USA	24	Ethernet and Serial	No
IC1D2B1AWS	IC1M2B1AWS	220 V AC USA	24	Ethernet and Serial	No
IC1D1B1BWS	IC1M1B1BWS	115 V AC USA	24	Ethernet and Serial	Yes
IC1D2B1BWS	IC1M2B1BWS	220 V AC USA	24	Ethernet and Serial	Yes
IC1D3B1BWS	IC1M2B1BWS	230 V AC Europe	24	Ethernet and Serial	Yes
IC1D1B3AWS	IC1M1B3AWS	115 V AC USA	24	PROFIBUS, Ethernet, and Serial	No
IC1D2B3AWS	IC1M2B3AWS	220 V AC USA	24	PROFIBUS, Ethernet, and Serial	No
IC1D1B3BWS	IC1M1B3BWS	115 V AC USA	24	PROFIBUS, Ethernet, and Serial	Yes
IC1D2B3BWS	IC1M2B3BWS	220 V AC USA	24	PROFIBUS, Ethernet, and Serial	Yes
IC1D3B3BWS	IC1M2B3BWS	230 V AC Europe	24	PROFIBUS, Ethernet, and Serial	Yes
IC1D1B4AWS	IC1M1B4AWS	115 V AC USA	24	DeviceNet, Ethernet, and Serial	No
IC1D2B4AWS	IC1M2B4AWS	220 V AC USA	24	DeviceNet, Ethernet, and Serial	No
IC1D1B4BWS	IC1M1B4BWS	115 V AC USA	24	DeviceNet, Ethernet, and Serial	Yes
IC1D2B4BWS	IC1M2B4BWS	220 V AC USA	24	DeviceNet, Ethernet, and Serial	Yes
IC1D3B4BWS	IC1M2B4BWS	230 V AC Europe	24	DeviceNet, Ethernet, and Serial	Yes
IC1D1B5AWS	IC1M1B5AWS	115 V AC USA	24	Interbus-S, Ethernet, and Serial	No
IC1D2B5AWS	IC1M2B5AWS	220 V AC USA	24	Interbus-S, Ethernet, and Serial	No
IC1D1B5BWS	IC1M1B5BWS	115 V AC USA	24	Interbus-S, Ethernet, and Serial	Yes
IC1D2B5BWS	IC1M2B5BWS	220 V AC USA	24	Interbus-S, Ethernet, and Serial	Yes
IC1D3B5BWS	IC1M2B5BWS	230 V AC Europe	24	Interbus-S, Ethernet, and Serial	Yes
IC1D1B6AWS	IC1M1B6AWS	115 V AC USA	24	EtherNet/IP, Modbus-TCP, Ethernet, and Serial	No
IC1D2B6AWS	IC1M2B6AWS	220 V AC USA	24	EtherNet/IP, Modbus-TCP, Ethernet, and Serial	No
IC1D1B6BWS	IC1M1B6BWS	115 V AC USA	24	EtherNet/IP, Modbus-TCP, Ethernet, and Serial	Yes
IC1D2B6BWS	IC1M2B6BWS	220 V AC USA	24	EtherNet/IP, Modbus-TCP, Ethernet, and Serial	Yes
IC1D3B6BWS	IC1M2B6BWS	230 V AC Europe	24	EtherNet/IP, Modbus-TCP, Ethernet, and Serial	Yes

DC Electric Controllers

Insight IC1Display & IC1Module

Measurement torque: Accuracy	±0.2% of torque full scale ±1 count of angle (degrees)
Measurement resolution	±0.025% of torque full scale
Torque transducer bridge excitation	±5V DC/GND
Torque transducer zero offset / drift compensation	±0.4% of full scale
Input signal sensitivity	2.0 mV/V
Calibration	Values read from spindle memory Automatic digital correction
Frequency response (torque filter)	Selectable 75 Hz, 150 Hz, 350 Hz, 500 Hz, 750 Hz
Keypad (IC-D only)	Membrane keypad containing 4 hot keys, 4 function keys, numerical keypad and directional keypad
Display	IC-D: 3.5-inch diagonal, 320px by 240px, 8-bit 65K backlit color (QVGA) flat panel display IC-M: 5- character, 7-segment numerical LED display
Parameter sets	256
Number of cycles stored in memory	IC-D: 1,000 IC-M: 200
Communication	Serial RS232, Ethernet, optional PROFIBUS, DeviceNet, Interbus-S, EtherNet / IP, Modbus - TCP
I/O	8 inputs / 8 outputs, with behavior assignable through ISC software: with optional I/O card, an additional 16 inputs and outputs are available
Indicators	Power ON lamp
Input voltage	Single-phase 120 volts, 50/60 Hz, 16 amps Single-phase 230 volts, 50/60 Hz, 8 amps
Ambient operating conditions	0 – 50° C, 20/90% non-condensing humidity
Enclosure	IP-52
System weight	5.6 kg (12.4 lb)
Dimensions (mm)	152 h x 191 w x 238d

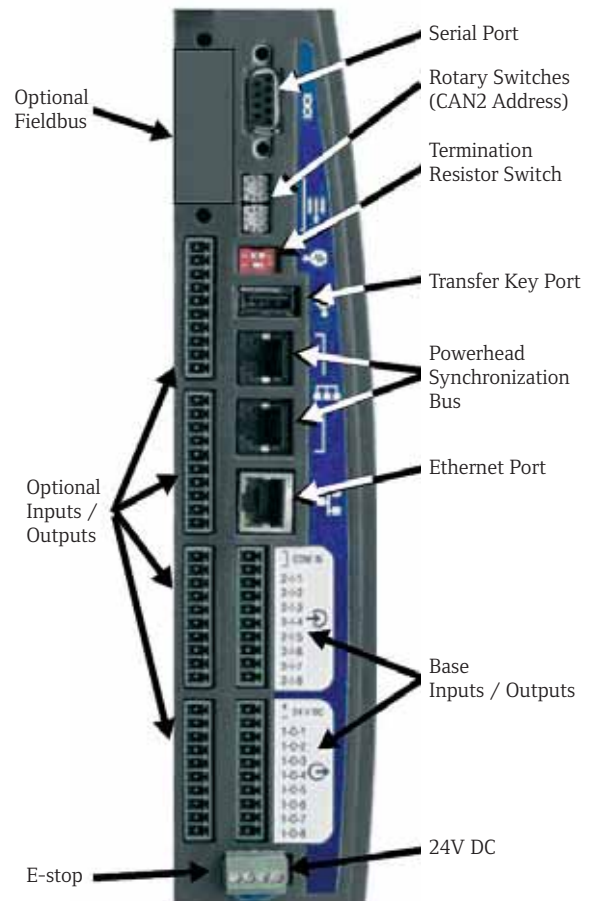

ICS Software

Paired with an Insight IC1D or IC1M controller and a computer, our groundbreaking ICS Software Suite makes it possible to more precisely control and monitor your fastening process. Optimizing your system is as simple as selecting one of four packages. Visibility of real-time data and controller status can be viewed from your desk top or other remote locations connected to your network. Additional specific information on each software package can be found on the following pages. Software is available in the following languages: Chinese, English, French, German, Italian, Russian and Spanish.

ICS Connect

ICS Connect gives operators the ability to access and program basic fastening strategies, as well as view cycle data with a single IC1D or IC1M controller via a one-to-one Ethernet connection. ICS Connect is supplied standard with all IC1D and IC1M controllers.

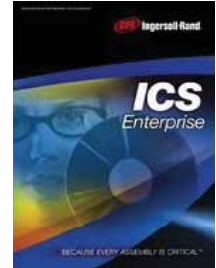

ICS Network

Description	Part Number	Licenses
ICS Network enables programming of multiple IC1D and IC1M controllers connected through a local area network (LAN) or direct connection. This option also allows operators to program advanced fastening strategies including yield and prevailing torque control. Finally, ICS Network unlocks the patented TactAlert feature of the QE Series tools that provides the operator with tactile feedback of a tool fault or NOK signal through gentle mechanical oscillation in the grip surface, reducing reliance on visual or audible signals.	ICS-NETWORK-001	1
	ICS-NETWORK-002	2
	ICS-NETWORK-005	5
	ICS-NETWORK-010	10
	ICS-NETWORK-020	20
	ICS-NETWORK-050	50
	ICS-NETWORK-100	100
	ICS-NETWORK-500	500

ICS MultiSync

Description	Part Number	Licenses
The ICS MultiSync package facilitates set-up and control of multiple spindle systems consisting of up to 100 spindles in groups of up to 40 spindles. This package also offers advanced multiple spindle fastening strategies such as fault back-out. Remote monitoring and data archiving are also standard features in this versatile package.	ICS-MULTISYNC-001	1
	ICS-MULTISYNC-002	2
	ICS-MULTISYNC-005	5
	ICS-MULTISYNC-010	10
	ICS-MULTISYNC-020	20
	ICS-MULTISYNC-050	50
	ICS-MULTISYNC-100	100

ICS Enterprise

Description	Part Number	Licenses
ICS Enterprise offers advanced programming and management of a network of up to 500 IC1D or IC1M controllers using QE tools, QM spindles, or multiple spindle systems. This package includes all elements of ICS Connect, Network, and MultiSync, and also enables ODBC-compliant database archiving, searching, and statistics processing.	ICS-ENTERPRISE-001	1
	ICS-ENTERPRISE-002	2
	ICS-ENTERPRISE-005	5
	ICS-ENTERPRISE-010	10
	ICS-ENTERPRISE-020	20
	ICS-ENTERPRISE-050	50
	ICS-ENTERPRISE-100	100
	ICS-ENTERPRISE-500	500

Additional versions of software have been developed to meet specific customer requirements and protocols.

Ingersoll Rand offers two levels of controllers and four levels of software. The IC1M controller can only be programmed via one of the software packages. The IC1D controller offers limited basic programming via the keypad. Either controller can be combined with any of the four ICS software packages to provide the features and level of sophistication required for various applications. The ICS Connect program is included standard with each controller. ICS site software is licensed based on the number of controllers to be connected to the network.

	IC1M Controller	IC1D Controller	ICS Connect	ICS Network	ICS MultiSync	ICS Enterprise
SOFTWARE PROGRAMMING						
Maximum Number of Configurations	256	256	256	256	256	256
Maximum Number of Steps per Configuration	32	32	1	32	32	32
Program Parameters: Editable		▲	▲	▲	▲	▲
Gang Count		▲	▲	▲	▲	▲
Auto Increment		▲	▲	▲	▲	▲
Quick Setup		▲	▲	▲	▲	▲
Advanced Setup				▲	▲	▲
Name Configuration			▲	▲	▲	▲
CW/CCW Tightening		▲	▲	▲	▲	▲
Tubenut Operation				▲	▲	▲
Adjustable Acceleration				▲	▲	▲
Optional End of Run Data for Each Step				▲	▲	▲
			▲	▲	▲	▲
DATA ARCHIVING						
Number of Stored End of Run Records	200	1000	Unlimited	Unlimited	Unlimited	Unlimited
Data Can be Transferred to					MS SQL	MS SQL
					▲	▲
POWERHEAD						
Powerhead Operation					▲	▲
Maximum Number of Spindles in Powerhead					40	40
Maximum Number of Groups					8	8
Fault Backout Options: None, Spindle, Group, Powerhead					▲	▲
Final Fault Backout Options: None, Spindle, Group, Powerhead					▲	▲
Synchronizing Spindles					▲	▲
SOFTWARE GENERAL						
Date/Time Set		▲	▲	▲	▲	▲
System Name			▲	▲	▲	▲
Select Language		▲	▲	▲	▲	▲
Network Time Protocol		▲	▲	▲	▲	▲
End of Run Onscreen Filter			▲	▲	▲	▲
End of Run Viewable on Screen	Value Only	▲	▲	▲	▲	▲
Load New Software via Ethernet	▲	▲	▲	▲	▲	▲

ICS Software

	ICTM Controller	ICTD Controller	ICS Connect	ICS Network	ICS MultiSync	ICS Enterprise
TOOL PROGRAMMING						
Transducer Value Adjustment		▲	▲	▲	▲	▲
Angle Scaling Constant Adjustment		▲	▲	▲	▲	▲
Transducer and ASC Reset		▲	▲	▲	▲	▲
Auto Calibration Function			▲	▲	▲	▲
Torque Units Selection		▲	▲	▲	▲	▲
Select Start Mode		▲	▲	▲	▲	▲
Tool Operation Selection		▲	▲	▲	▲	▲
Special Function Switch		▲	▲	▲	▲	▲
Configuration Mode Selection		▲	▲	▲	▲	▲
Set Preventive Maintenance Alarms				▲	▲	▲
View Tool Memory			▲	▲	▲	▲
PASSWORDS						
Number of Passwords	0	1	Unlimited	Unlimited	Unlimited	Unlimited
Auto Timer Lockout		▲				
STATISTICS						
Sample and Population Statistics		▲	▲	▲	▲	▲
Statistics Values Calculated	Cp, Cpk, Mean, SD, Capability, CAM, Max Value, Min Value, % Number of Rejects, % Number of Pass, Number of Rejects High, Number of Rejects Low, Mean Shift, Range					
Statistics Alarms			▲	▲	▲	▲
Statistics Alarms Output	▲	▲	▲	▲	▲	▲
Maximum Sample Statistics Size	200	1000	1000	1000	1000	1000
Powerhead Statistics					▲	▲
Mean Range Charts				▲	▲	▲
Histograms				▲	▲	▲
Pareto Chart				▲	▲	▲
Statistics E-mail Alarms					▲	▲
Stats Calculation from User Selected Data				▲	▲	▲
TIGHTENING CURVES						
Curve Types	Torque vs Angle, Torque vs Time, Current vs Time					
Curves Stored on Controller	Last Reject Last Cycle	Last Reject Last Cycle				
Display Curves On Screen				▲	▲	▲
Print Tightening Curves				▲	▲	▲
Print Tightening Curve Data				▲	▲	▲
Full View				▲	▲	▲
Zoom Function				▲	▲	▲
Number of Curves that Can be Overlaid				1	10	10
Archive Curves					▲	▲
Parameter Values Shown on Curve				▲	▲	▲

	ICTM Controller	ICTD Controller	ICS Connect	ICS Network	ICS MultiSync	ICS Enterprise
TIGHTENING STRATEGIES						
Torque Control		▲	▲	▲	▲	▲
Torque Control with Angle Monitoring				▲	▲	▲
Torque Control with Yield Override				▲	▲	▲
Angle Control		▲	▲	▲	▲	▲
Angle Control with Torque Monitoring				▲	▲	▲
Angle Control with Yield Override				▲	▲	▲
Yield Control				▲	▲	▲
Prevailing Torque				▲	▲	▲
Drag Torque				▲	▲	▲
Backout				▲	▲	▲
Fault Backout					▲	▲
Final Fault Backout					▲	▲
Retorque				▲	▲	▲
Wait				▲	▲	▲
Jog				▲	▲	▲
Bypass				▲	▲	▲
COMMUNICATIONS						
Serial End of Run Data Out		▲	▲	▲	▲	▲
Serial Custom End of Run Data			▲	▲	▲	▲
Host Data Out		▲	▲	▲	▲	▲
PFCS				▲	▲	▲
Plus				▲		▲
Barcode Passive				▲	▲	▲
Barcode Active				▲	▲	▲
Barcode Setup on Screen				▲	▲	▲
Field Bus Setup on Screen				▲	▲	▲
Ethernet End of Run Setup				▲	▲	▲
Ethernet End of Run				▲	▲	▲
Ethernet Programming				▲	▲	▲

ICS Software

	ICTM Controller	ICTD Controller	ICS Connect	ICS Network	ICS MultiSync	ICS Enterprise
DIAGNOSTICS						
Error Codes	▲					
Text Errors		▲	▲	▲	▲	▲
System Test		▲	▲	▲	▲	▲
Store System Test Results			▲	▲	▲	▲
View Input Status		▲	▲	▲	▲	▲
Set Output Status		▲	▲	▲	▲	▲
View Outputs		▲	▲	▲	▲	▲
Assign Inputs			▲	▲	▲	▲
Assign Outputs			▲	▲	▲	▲
Event Log			▲	▲	▲	▲
View Event Log			▲	▲	▲	▲
Tool Test		▲	▲	▲	▲	▲
Lamp Test		▲	▲	▲	▲	▲
HELP						
Help Screen Menu			▲	▲	▲	▲
Wizard Text		▲				
PRINTED REPORTS						
Number of Reports	0	0	6	6	9	11
Report Types	Cycle Log, Stats, Parameter Dump, Diagnostics, Event Log, Tightening Curve					
					Histogram, Pareto, Mean/Range	Histogram, Pareto, Mean/Range VIN, Custom
Export to File Function			▲	▲	▲	▲

DC Electric

Accessories

Standard and Extension Cables

Part Number	Description
GEA40-CORD-3M	3 m Standard Cable
GEA40-CORD-6M	6 m Standard Cable
GEA40-CORD-10M	10 m Standard Cable
GEA40-CORD-3M-90	3 m 90 Degree Cable
GEA40-CORD-6M-90	6 m 90 Degree Cable
GEA40-CORD-10M-90	10 m 90 Degree Cable
GEA40-EXT-10M	10 m Extension Cable
GEA40-EXT-20M	20 m Extension Cable
GEA40-EXT-40M	40 m Extension Cable
GEA40-INT-01	50" 90 degree Extension Cable
GEA40-INT-02	60" 90 degree Extension Cable
GEA40-INT-03	70" 90 degree Extension Cable
GEA40-INT-04	80" 90 degree Extension Cable
GEA40-INT-05	90" 90 degree Extension Cable
GEA40-INT-06	100" 90 degree Extension Cable
GEA40-INT-07	110" 90 degree Extension Cable
GEA40-INT-08	120" 90 degree Extension Cable
GEA40-INT-09	130" 90 degree Extension Cable



Standard Cable



90 Degree Cable

Lever Kits

Part Number	Description
GEA40-K98SL	Short Lever Kit
GEA40-K98EL	Extended Lever Kit

Hanging and Mounting Accessories

Part Number	Description	For Use With
GEA15-K364	Swivel Hanger Kit	QE4
GEA40-K364	Swivel Hanger Kit	QE6 & QE8
7L-365	Suspension Bail	All QE Series
GEA15-K48	Reaction Bar Kit	QE4, QA4 inline up to 27 Nm
GEPTS15-K48	Reaction Bar Kit	QE4TS
DEA120-K48	Reaction Bar Kit	QE6 & QE8, QA4 inline 46 Nm
15E4-K48	Flanged Mounting Kit	QE4, QA4 / QA8 inline up to 55 Nm, angle up to 55 Nm
GEM120-K48	Flanged Mounting Kit	QE6 & QE8, QA6 / QA8 inline 70 / 90 Nm, angle 115 / 150 Nm
GEA4-K48	Mounting Plate Kit	QE4, QA6 / QA8 inline up to 55 Nm, angle up to 90 Nm
DAM120-K48	Mounting Plate Kit	QE6 & QE8, QA6 / QA8 inline 70 / 90 Nm, angle 115 / 150 Nm



Flange Mounting Kit



Mounting Plate Kit



Swivel Hanger Kit

DC Electric

Accessories

Controller Accessories

Part Number	Description
IC-PALM-RESET	Palm Button Reset Station
IC-ESTOP	Emergency Stop Button
IC-LIGHT-TOWER	Light Tower
3002007	Wall Mounting Bracket For IC1D/M
3002010	Cabinet Mounting Bracket For IC1D/M
IC-SELECT-2	2-Position Remote Selector Switch
IC-SELECT-4	4-Position Remote Selector Switch
IC-SELECT-6	6-Position Remote Selector Switch
80150113	Controller Transfer Key



Palm Reset



Emergency Stop



Light Tower

Socket Trays and Accessories

Part Number	Description
IC-SOCKET-4	4-position socket tray
IC-SOCKET-8	8-position socket tray
IC-10PIN-6M	6 m cable for 4-position tray
IC-10PIN-10M	10 m cable for 4-position tray
IC-19PIN-5M	5 m cable for 8-position tray
IC-19PIN-10M	10 m cable for 8-position tray
GEA15-38KIT-5	3/8" socket pin kit
GEA40-12KIT-5	1/2" socket pin kit



4-Position Socket Tray

Calibration Equipment

ETA Series – Expert Torque Analyzer

Features

- Use with a variety of transducers to dynamically measure and record output of all types of fastening tools, including pulse
- Full statistical capability and the ability to download to a PC via the RS232 cable
- Membrane keypad, four-line LED display and torque status lights
- Heavy-duty housing features protective rubber trim
- Pair with the wide selection of Ingersoll Rand transducers and joint kits to cover all your calibration needs
- Memory: 20,000 readings
- Accepts bar code input



Service and Accessories

Manuals:



P7529

Accessories:

Transducer and joint kits, see pages 52 – 53
 Transducer cable: ETA2-TC
 PC software: ETW-CONNECT

Model	Description	Units of Measure	Data Analysis	Number of Configurators	Languages	Recording Models
ETA5	Expert Torque Analyzer	9	CP, CPK, CM, CPM	250	English, German, French Italian, Spanish, Swedish	peak, click, pulse, track

ETA5 Unit Includes:

ETA5	Torque analyzer
ETA2-STRAP	Camera-type neck strap
ETA2-BC	Battery charger
ETA2-P525	Port saver
ETA2-PC99	PC connector cable
ETA2-P925	Printer cable
ETA2-CASE	Carrying case
ETA2-99	Certification of calibration

Calibration Equipment

ETT Series – Expert Torque Testers

Features

- Ideal for testing output torque on most hand screwdrivers, wrenches, or power tools in the calibration lab, repair crib, or on the production line
- Four operating modes: Peak, click, impulse, and track
- Data transfer function to a PC or a printer via the RS232 port
- Quick-clamp mounts integrated into the housing
- 8 hours of battery power under normal use; equipped with auto power-down timer
- Includes certificate of calibration

Service and Accessories

Manuals:





P7574

Accessories:

Printer cable: ETA2-P925

Quick disconnect plate: ETT-QD



		Accuracy FSD		
Model	in-lbs (Nm)		lbs (kg)	in (mm)
ETT-1-US	0.88 – 8.8 (0.1 – 1)	0.5%	5.0 (2.7)	9-1/4" x 8-1/4" x 2-1/4" (213 x 238 x 70)
ETT-4-US	3.50 – 35 (0.4 – 4)	0.5%	5.0 (2.7)	9-1/4" x 8-1/4" x 2-1/4" (213 x 238 x 70)
ETT-12-US	10.6 – 106 (1.2 – 12)	0.5%	5.0 (2.7)	9-1/4" x 8-1/4" x 2-1/4" (213 x 238 x 70)
ETT-30-US	26.5 – 265 (3.0 – 30)	0.5%	5.0 (2.7)	9-1/4" x 8-1/4" x 2-1/4" (213 x 238 x 70)

ETT Unit Includes:

ETT-BC	Battery Charger
ETT-RA	Rundown Adapter
ETA2-PC99	PC Connector (RS232)
ETT-CASE	Carrying Case
ETT-P7574	Operating Manual
ETA2-99	Certification of Calibration

Expert Torque Wrenches

Features

- An indispensable item for developing, meeting, and verifying virtually any tightening specification for bolted assemblies
- Torque, angle, yield, and dynamic torque tracking modes
- Perform advanced tightening strategies including closed-loop torque control, angle control, and yield control
- Ability to store up to 1500 final tightening values and then download the results to a PC
- Tri-color LED display and buzzer for visual and audible indication of cycle status
- Includes rechargeable batteries with up to 8 hours of continuous use
- Includes certificate of calibration



ETW-E75

Service and Accessories

Manuals:

 04581922

Accessories:

PC software: ETW-CONNECT

PC cable: ETW-ED9B

1/4" square ratchet head: ETW-E25-R04

3/8" square ratchet head: ETW-E75-R06

1/2" square ratchet head: ETW-E180-R08

Universal battery charger: ETW-EBC

Rechargeable battery pack: ETW-EBP

Carrying case: ETW-ECC

Colored Boots:

ETW-BOOT-RD (Red)

ETW-BOOT-GN (Green)

ETW-BOOT-YL (Yellow)

Part Number	ETW-E25	ETW-E75	ETW-E180
Torque Capacity (Nm)	25	55	180
Square drive	1/4"	3/8"	1/2"
Torque Units	Nm, Ncm, lb-ft, Kgm, Kgcm		
Overload Capacity	125% max capacity of wrench		
Torque Accuracy	+ / - max 0.5% capacity of wrench		
Angle Range	0 – 3000°		
Tightening Direction	CW & CCW		
Operating Temperature Range	5° – 40° Celsius (41 – 104° Fahrenheit)		
Storage Temperature Range	0° – 50° Celsius (32 – 122° Fahrenheit)		
Temperature Stability	+ / - 0.1% per °C		
Humidity Range	5% – 75% non-condensing		
Sealing	IP54		
Weight	2.2 lb (1 kg)		
Length	20.2" (512 mm)		
Width	1.9" (48 mm)		
Depth	1.5" (38 mm)		
Power	Rechargeable cell pack (typically 8 h of continuous use)		

Calibration Equipment

Transducer & Joint Kits

Rotary Transducers:

- Industry-standard – works with ETA analyzers and other equipment that utilizes industry-standard transducers
- ETA “Smart” Series – the range and calibration will auto-identify when working with the ETA analyzer (available in Torque and Torque/Angle models)

Manuals:



Industry Standard*	ETA Series “Smart” Transducers		in-lbs (Nm)	
	Torque	Torque & Angle	in-lbs (Nm)	in
ROTARY TRANSDUCERS				
TR2H4	—	—	1.0 – 18 (0.10 – 2)	1/4"
TR5H4	TRD5H4	TRDA5H4	2.2 – 44 (0.25 – 5)	1/4"
TR20H4	TRD20H4	TRDA20H4	9.0 – 180 (1 – 20)	1/4"
TR20S4	TRD20S4	TRDA20S4	9.0 – 180 (1 – 20)	1/4"
TR75S6	TRD75S6	TRDA75S6	2.8 – 55 (3.8 – 75)	3/8"
TR180S8	TRD180S8	TRDA180S8	6.7 – 133 (9 – 180)	1/2"
TR250S12	—	—	9.2 – 185 (12.5 – 250)	3/4"
TR500S12	TRD500S12	TRDA500S12	18.5 – 370 (25 – 500)	3/4"

*Industry-standard transducers require ETA2-TC cable.

Stationary Transducers:

- Industry-standard – works with ETA analyzers and other equipment that utilizes industry-standard transducers
- ETA “Smart” Series – the range and calibration will auto-identify when working with the ETA analyzer

Manuals:



Shown with joint kit

Stationary Transducer	ETA Series “Smart” Transducers		ft-lbs (Nm)	
			ft-lbs (Nm)	in
STATIONARY TRANSDUCERS				
TS30S4	TSD28S4		1.1 – 22 (1.5 – 30)	1/4"
TS150S6	TSD135S6		5.5 – 110 (7.5 – 150)	3/8"
TS300S8	TSD270S8		11 – 221 (15 – 300)	1/2"
TS1000S12	TSD1000S12		37 – 738 (50 – 1000)	3/4"

Transducer & Joint Kits

Joint Simulators:











- Range up to 1000 Nm
- Rate can be changed to emulate different joint conditions from hard to soft
- Available with or without an industry-standard stationary transducer









Manuals:

 P7529



Model		
	Nm	in
STATIONARY TRANSDUCER WITH JOINT SIMULATOR		
JKST30	1.5 – 30	1/4" 
JKST150	7.5 – 135	3/8" 
JKST300	15 – 300	1/2" 
JKST1000	50 – 1000	3/4" 
FOR STATIONARY TRANSDUCERS		
JKS30	30	1/4" 
JKS150	150	3/8" 
JKS300	300	1/2" 
JKS1000	1000	3/4" 

Model		
	Nm	in
FOR ROTARY TRANSDUCERS		
JKR20	20	1/4" 
JKR75	75	3/8" 
JKR180	180	1/2" 
JKR500	500	3/4" 

Air Fastening Tools

Ingersoll Rand offers a full line of production fastening equipment, including air screwdrivers, nutrunners, pulse tools, qualifiers, and fixtured systems in a broad range of configurations. Whether you need a solution for a single, specific application or an entire assembly line, you can trust our century of tool design experience to deliver tools that are durable enough for your toughest high-volume applications, yet still deliver the speed and accuracy you need. From Adjustable Precision Shutoff nutrunners and screwdrivers to transducerized Pulse tools, our broad product line offers the flexibility to choose the exact solution to fit your application and maximize your productivity.



55

Pistol Grip Screwdrivers



78

Inline Screwdrivers



94

Angle Nutrunners

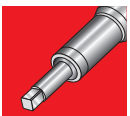

115

Inline Nutrunners



125

Pulse Tools





Pistol Grip Air Screwdrivers

Torque Selection Guide

Adjustable Shut-Off Clutch



Model	0	2 Nm	4 Nm	6 Nm	8 Nm	10 Nm	12 Nm	Referral page
AG027A-26-Q	0	2						59
AG027A-15-Q	0	2	4					59
QP1T20S1D	0	2	4	6				58
1RTNS1	0	2	4	6	8			56
QP1T10S1D	0	2	4	6	8			58
AG027A-8-Q	0	2	4	6	8			59
41PA24TSQ4	0	2	4	6	8			62
1RTQS1	0	2	4	6	8	10		56
QP1T02S1D	0	2	4	6	8	10		58
41PA10TSQ4	0	2	4	6	8	10	12	62
41PA8TSQ4	0	2	4	6	8	10	12	62

Adjustable Cushion Clutch

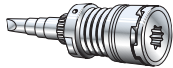

Model	0	2 Nm	4 Nm	6 Nm	8 Nm	10 Nm	12 Nm	14 Nm	Referral page
SG023B-26-Q	0	2							64
SG023B-15-Q	0	2	4						64
QP1P20C1D	0	2	4	6					65
1RANCI	0	2	4	6	8				63
SG023B-9-Q	0	2	4	6	8				64
41PC25TSQ4	0	2	4	6	8	10			66
QP1S05C1D	0	2	4	6	8	10			65
5RANCI	0	2	4	6	8	10	12		67
41PC10TSQ4	0	2	4	6	8	10	12		66
41PC8TSQ4	0	2	4	6	8	10	12	14	66
7RALC1	0	2	4	6	8	10	12	14	67
7RAMC1	0	2	4	6	8	10	12	14	67

Positive Jaw



Model	0	2 Nm	4 Nm	6 Nm	8 Nm	10 Nm	12 Nm	14 Nm	16 Nm	18 Nm	20 Nm	Referral page
SG022B-26-Q	0	2										69
5RALP1	0	2	4									72
SG022B-9-Q	0	2	4	6								69
41PP25TSQ4	0	2	4	6	8							71
5RANP1	0	2	4	6	8	10						72
41PP10TSQ4	0	2	4	6	8	10	12					71
7RAMP1	0	2	4	6	8	10	12	14				72
41PP8TSQ4	0	2	4	6	8	10	12	14	16			71
7RANP1	0	2	4	6	8	10	12	14	16	18	20	72

Stall



Model	0	2 Nm	4 Nm	6 Nm	8 Nm	10 Nm	12 Nm	14 Nm	Referral page
SG021B-26-Q	0	2							74
SG021B-15-Q	0	2	4						74
SG021B-9-Q	0	2	4	6					74
QP1S20D1D	0	2	4	6	8				73
5RALD1	0	2	4	6	8				75
QP1S10D1D	0	2	4	6	8	10			73
41PD25TSQ4	0	2	4	6	8	10			76
7RALD1	0	2	4	6	8	10	12		75
QP1S05D1D	0	2	4	6	8	10	12		73
41PD10TSQ4	0	2	4	6	8	10	12	14	76
41PD8TSQ4	0	2	4	6	8	10	12	14	76

Pistol Grip Air Screwdrivers

Adjustable Shut-Off Clutch

1 Series

Time-tested design provides repeatable results, day in and day out, at an economical price.

Features

- Torque range: 2.7 – 45 in-lbs (0.3 – 5.1 Nm)
- Speeds: 250 – 2,000 rpm
- Compact and lightweight
- Coated grip for operator comfort
- Recommended for applications where precise torque control is required

Service and Accessories

Manuals:

- 16574550
- 80167265

Accessories:

- Torque arm: QTA010
- Spring balancer, see page 177
- Spindle accessories, see page 183
- Suspension bail: 3RA-365
- Exhaust hose: 3RL-284

Kits:

- Tune-up kit: 3RA-TK2

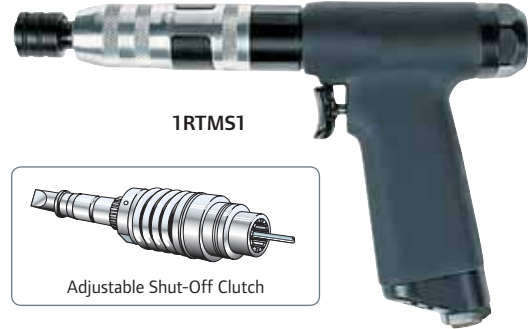

1RTMS1

Adjustable Shut-Off Clutch

Model	in-lbs (Nm)	in-lbs (Nm)	in-lbs (Nm)	rpm	lbs (kg)	in (mm)	in (mm)	in	cfm (L/min)
DC TRIGGER + PUSH-TO-START									
1RTMS1	4.4 – 15.9 (0.5 – 1.8)	6.2 – 20.4 (0.7 – 2.3)	–	1,650	1.5 (0.7)	8.5" (217)	0.7" (17)	1/4"	13 (368)
1RTNS1	2.7 – 15.9 (0.3 – 1.8)	4.4 – 23.0 (0.5 – 2.6)	9.7 – 30.1 (1.1 – 3.4)	1,000	1.5 (0.7)	8.5" (217)	0.7" (17)	1/4"	13 (368)
1RTQS1	2.7 – 15.9 (0.3 – 1.8)	4.4 – 23.0 (0.5 – 2.6)	9.7 – 45.1 (1.1 – 5.1)	500	1.5 (0.7)	8.7" (222)	0.7" (17)	1/4"	13 (368)

Series			
1	73 dBa	1/8" NPT	1/4" (6 mm)

Q2 Series

Sets the standard for assembly tool ergonomics.

Features

- Torque range: 3.0 – 47.8 in-lbs (0.3 – 5.4 Nm)
- Speeds: 250 – 2,000 rpm
- Compact, lightweight, well-balanced design
- Contoured soft grip handle
- Two-finger trigger distributes grip force and reduces stress
- Top or bottom air inlets allow for optimal mounting
- Interchangeable handles offer custom fit for various hand sizes
- Recommended for applications where precise torque control is required



Service and Accessories

Manuals:

- 16574527
- 80165939
- 16575219

Accessories:

- Torque arm: QTA010
- Spring balancer, see page 177
- Spindle accessories, see page 183
- Hanger: TRP-A365

Kits:

- Inlet / throttle / motor tune-up kit: Q2PFAST-TK1
- ASO clutch tune-up kit: Q2-ASO-TK1

Model	in-lbs (Nm)	in-lbs (Nm)	in-lbs (Nm)	rpm	lbs (kg)	in (mm)	in (mm)	in	cfm (L/min)
PUSH-TO-START									
QP1P20S1D	2.7 – 9.7 (0.3 – 1.1)	8.0 – 22.1 (0.9 – 2.5)	–	2,000	1.9 (0.8)	8.8" (223)	0.6" (15)	1/4"	16 (450)
QP1P10S1D	2.7 – 9.7 (0.3 – 1.1)	8.0 – 27.3 (0.9 – 3.1)	13.3 – 39.8 (1.5 – 4.5)	1,000	1.9 (0.8)	8.8" (223)	0.6" (15)	1/4"	16 (450)
QP1P10S1TD*	2.7 – 9.7 (0.3 – 1.1)	8.0 – 27.3 (0.9 – 3.1)	13.3 – 39.8 (1.5 – 4.5)	1,000	1.9 (0.8)	8.8" (223)	0.6" (15)	1/4"	16 (450)
QP1P05S1D	2.7 – 9.7 (0.3 – 1.1)	8.0 – 28.3 (0.9 – 3.2)	13.3 – 47.8 (1.5 – 5.4)	500	1.9 (0.8)	8.8" (223)	0.6" (15)	1/4"	16 (450)
QP1P05S1TD*	2.7 – 9.7 (0.3 – 1.1)	8.0 – 28.3 (0.9 – 3.2)	13.3 – 47.8 (1.5 – 5.4)	500	1.9 (0.8)	8.8" (223)	0.6" (15)	1/4"	16 (450)
QP1P02S1TD*	2.7 – 9.7 (0.3 – 1.1)	8.0 – 28.3 (0.9 – 3.2)	13.3 – 47.8 (1.5 – 5.4)	250	1.9 (0.8)	8.8" (223)	0.6" (15)	1/4"	16 (450)

*Top air inlet.

















(continued next page)

Series			
Q2	75 dBa	1/4" NPT	1/4" (6 mm)

Pistol Grip Air Screwdrivers

Adjustable Shut-Off Clutch

Q2 Series (continued)

Model	in-lbs (Nm)	in-lbs (Nm)	in-lbs (Nm)	rpm	lbs (kg)	in (mm)	in (mm)	in	cfm (L/min)
DC TRIGGER START									
QP1S20S1D	2.7 – 9.7 (0.3 – 1.1)	8.0 – 22.1 (0.9 – 2.5)	–	2,000	1.9 (0.8)	8.8" (223)	0.6" (15)	1/4" 	16 (450)
QP1S20S1TD*	2.7 – 9.7 (0.3 – 1.1)	8.0 – 22.1 (0.9 – 2.5)	–	2,000	1.9 (0.8)	8.8" (223)	0.6" (15)	1/4" 	16 (450)
QP1S10S1D	2.7 – 9.7 (0.3 – 1.1)	8.0 – 27.3 (0.9 – 3.1)	13.3 – 39.8 (1.5 – 4.5)	1,000	1.9 (0.8)	8.8" (223)	0.6" (15)	1/4" 	16 (450)
QP1S10S1TD*	2.7 – 9.7 (0.3 – 1.1)	8.0 – 27.3 (0.9 – 3.1)	13.3 – 39.8 (1.5 – 4.5)	1,000	1.9 (0.8)	8.8" (223)	0.6" (15)	1/4" 	16 (450)
QP1S05S1D	2.7 – 9.7 (0.3 – 1.1)	8.0 – 28.3 (0.9 – 3.2)	13.3 – 47.8 (1.5 – 5.4)	500	1.9 (0.8)	8.8" (223)	0.6" (15)	1/4" 	16 (450)
QP1S05S1TD*	2.7 – 9.7 (0.3 – 1.1)	8.0 – 28.3 (0.9 – 3.2)	13.3 – 47.8 (1.5 – 5.4)	500	1.9 (0.8)	8.8" (223)	0.6" (15)	1/4" 	16 (450)
QP1S02S1TD*	2.7 – 9.7 (0.3 – 1.1)	8.0 – 28.3 (0.9 – 3.2)	13.3 – 47.8 (1.5 – 5.4)	250	1.9 (0.8)	8.8" (223)	0.6" (15)	1/4" 	16 (450)
DC TRIGGER + PUSH-TO-START									
QP1T20S1D	2.7 – 9.7 (0.3 – 1.1)	8.0 – 22.1 (0.9 – 2.5)	–	2,000	1.9 (0.8)	8.8" (223)	0.6" (15)	1/4" 	16 (450)
QP1T20S1TD*	2.7 – 9.7 (0.3 – 1.1)	8.0 – 22.1 (0.9 – 2.5)	–	2,000	1.9 (0.8)	8.8" (223)	0.6" (15)	1/4" 	16 (450)
QP1T10S1D	2.7 – 9.7 (0.3 – 1.1)	8.0 – 27.3 (0.9 – 3.1)	13.3 – 39.8 (1.5 – 4.5)	1,000	1.9 (0.8)	8.8" (223)	0.6" (15)	1/4" 	16 (450)
QP1T10S1TD*	2.7 – 9.7 (0.3 – 1.1)	8.0 – 27.3 (0.9 – 3.1)	13.3 – 39.8 (1.5 – 4.5)	1,000	1.9 (0.8)	8.8" (223)	0.6" (15)	1/4" 	16 (450)
QP1T10S3D	2.7 – 9.7 (0.3 – 1.1)	8.0 – 27.3 (0.9 – 3.1)	13.3 – 39.8 (1.5 – 4.5)	1,000	1.9 (0.8)	8.8" (223)	0.6" (15)	1/4" 	16 (450)
QP1T05S1D	2.7 – 9.7 (0.3 – 1.1)	8.0 – 28.3 (0.9 – 3.2)	13.3 – 47.8 (1.5 – 5.4)	500	1.9 (0.8)	8.8" (223)	0.6" (15)	1/4" 	16 (450)
QP1T05S1TD*	2.7 – 9.7 (0.3 – 1.1)	8.0 – 28.3 (0.9 – 3.2)	13.3 – 47.8 (1.5 – 5.4)	500	1.9 (0.8)	8.8" (223)	0.6" (15)	1/4" 	16 (450)
QP1T05S3D	2.7 – 9.7 (0.3 – 1.1)	8.0 – 28.3 (0.9 – 3.2)	13.3 – 47.8 (1.5 – 5.4)	500	1.9 (0.8)	8.8" (223)	0.6" (15)	1/4" 	16 (450)
QP1T02S1D	2.7 – 9.7 (0.3 – 1.1)	8.0 – 28.3 (0.9 – 3.2)	13.3 – 47.8 (1.5 – 5.4)	250	1.9 (0.8)	8.8" (223)	0.6" (15)	1/4" 	16 (450)
QP1T02S1TD*	2.7 – 9.7 (0.3 – 1.1)	8.0 – 28.3 (0.9 – 3.2)	13.3 – 47.8 (1.5 – 5.4)	250	1.9 (0.8)	8.8" (223)	0.6" (15)	1/4" 	16 (450)

*Top air inlet.

Series			
Q2	75 dBa	1/4" NPT	1/4" (6 mm)

20 Series

Legendary performance in a compact, lightweight package.

Features

- Torque range: 3.0 – 40 in-lbs (0.34 – 4.5 Nm)
- Speeds: 800 – 2,600 rpm
- Skinsulate housing provides comfortable grip surface
- One-handed reverse lever
- Recommended for applications where precise torque control is required

Service and Accessories

Manuals:

 49999246









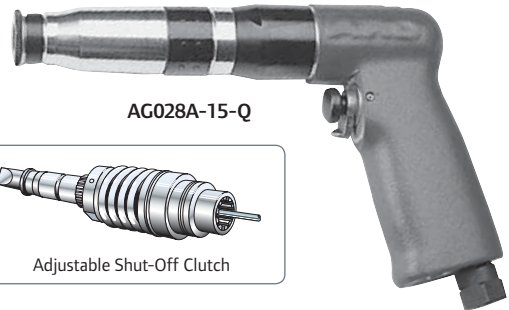

Accessories:

Torque arm: QTA010
 Suspension bail: 48934
 Spring balancer: BLD1
 Spindle accessories, see page 183

Kits:

Tune-up kit: 48846



Model	in-lbs (Nm)	in-lbs (Nm)	in-lbs (Nm)	rpm	lbs (kg)	in (mm)	in (mm)	in	cfm (L/min)
TRIGGER START									
AG027A-15-Q	3.0 – 10 (0.34 – 1.1)	8.0 – 20 (0.9 – 2.3)	-	1,500	1.9 (0.9)	8.3" (210)	0.7" (17)	1/4" 	15 (420)
AG027A-9-Q	3.0 – 10 (0.34 – 1.1)	8.0 – 20 (0.9 – 2.3)	10 – 30 (1.1 – 3.4)	900	1.9 (0.9)	8.3" (210)	0.7" (17)	1/4" 	15 (420)
AG027A-8-Q	4.0 – 13 (0.5 – 1.5)	10 – 26 (1.1 – 2.9)	12 – 40 (1.4 – 4.5)	800	1.9 (0.9)	8.3" (210)	0.7" (17)	1/4" 	15 (420)
PUSH-TO-START									
AG024A-15-Q	3.0 – 10 (0.34 – 1.1)	8.0 – 20 (0.9 – 2.3)	-	1,500	1.9 (0.9)	8.3" (210)	0.7" (17)	1/4" 	15 (420)
AG024A-9-Q	3.0 – 10 (0.34 – 1.1)	8.0 – 20 (0.9 – 2.3)	10 – 30 (1.1 – 3.4)	900	1.9 (0.9)	8.3" (210)	0.7" (17)	1/4" 	15 (420)
AG024A-8-Q	4.0 – 13 (0.5 – 1.5)	10 – 26 (1.1 – 2.9)	12 – 40 (1.4 – 4.5)	800	1.9 (0.9)	8.3" (210)	0.7" (17)	1/4" 	15 (420)
TRIGGER + PUSH-TO-START									
AG028A-26-Q	3.0 – 10 (0.34 – 1.1)	-	-	2,600	1.8 (0.8)	7.9" (200)	0.7" (17)	1/4" 	15 (420)
AG028A-15-Q	3.0 – 10 (0.34 – 1.1)	8.0 – 20 (0.9 – 2.3)	-	1,500	1.9 (0.9)	8.3" (210)	0.7" (17)	1/4" 	15 (420)
AG028A-9-Q	3.0 – 10 (0.34 – 1.1)	8.0 – 20 (0.9 – 2.3)	10 – 30 (1.1 – 3.4)	900	1.9 (0.9)	8.3" (210)	0.7" (17)	1/4" 	15 (420)
AG028A-8-Q	4.0 – 13 (0.5 – 1.5)	10 – 26 (1.1 – 2.9)	12 – 40 (1.4 – 4.5)	800	1.9 (0.9)	8.3" (210)	0.7" (17)	1/4" 	15 (420)

Series			
20	76 dBa	1/4 NPT	5/16" (8 mm)

Pistol Grip Air Screwdrivers

Adjustable Shut-Off Clutch

50 Series

Legendary performance with a well-deserved reputation for durability.

Features

- Torque range: 15 – 100 in-lbs (1.7 – 11.3 Nm)
- Speeds: 800 – 2,400 rpm
- Skinsulate housing provides comfortable grip surface
- One-handed reverse lever
- Recommended for applications where precise torque control is required

Service and Accessories









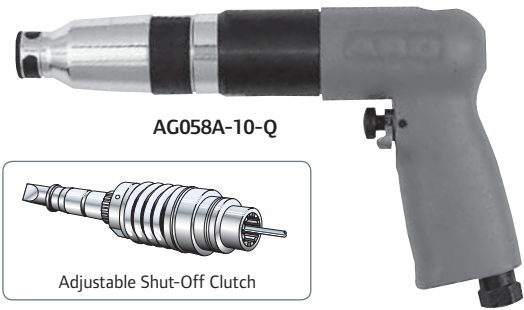



Manuals:

 49999067

Accessories:

Torque arm: QTA010
Suspension bail: 48934
Dead handle: 728N-A48
Spring balancer, see page 177
Spindle accessories, see page 183



Model	in-lbs (Nm)	in-lbs (Nm)	in-lbs (Nm)	rpm	lbs (kg)	in (mm)	in (mm)	in	cfm (L/min)
DC TRIGGER START									
AG057A-24-Q	15 – 40 (1.7 – 4.5)	–	–	2,400	2.7 (1.2)	8.4" (212)	0.9" (22)	1/4" 	25 (720)
AG057A-16-Q	15 – 40 (1.7 – 4.5)	25 – 60 (2.8 – 6.8)	–	1,600	2.9 (1.3)	8.9" (225)	0.9" (22)	1/4" 	25 (720)
AG057A-10-Q	15 – 40 (1.7 – 4.5)	25 – 60 (2.8 – 6.8)	35 – 80 (4.0 – 9.0)	1,000	2.9 (1.3)	8.9" (225)	0.9" (22)	1/4" 	25 (720)
AG057A-8-Q	15 – 40 (1.7 – 4.5)	25 – 60 (2.8 – 6.8)	35 – 100 (4.0 – 11.3)	800	2.9 (1.3)	8.9" (225)	0.9" (22)	1/4" 	25 (720)
DC PUSH-TO-START									
AG054A-24-Q	15 – 40 (1.7 – 4.5)	–	–	2,400	2.7 (1.2)	8.4" (212)	0.9" (22)	1/4" 	25 (720)
AG054A-16-Q	15 – 40 (1.7 – 4.5)	25 – 60 (2.8 – 6.8)	–	1,600	2.9 (1.3)	8.9" (225)	0.9" (22)	1/4" 	25 (720)
AG054A-10-Q	15 – 40 (1.7 – 4.5)	25 – 60 (2.8 – 6.8)	35 – 80 (4.0 – 9.0)	1,000	2.9 (1.3)	8.9" (225)	0.9" (22)	1/4" 	25 (720)
AG054A-8-Q	15 – 40 (1.7 – 4.5)	25 – 60 (2.8 – 6.8)	35 – 100 (4.0 – 11.3)	800	2.9 (1.3)	8.9" (225)	0.9" (22)	1/4" 	25 (720)
DC TRIGGER + PUSH-TO-START									
AG058A-24-Q	15 – 40 (1.7 – 4.5)	–	–	2,400	2.7 (1.2)	8.4" (212)	0.9" (22)	1/4" 	25 (720)
AG058A-16-Q	15 – 40 (1.7 – 4.5)	25 – 60 (2.8 – 6.8)	–	1,600	2.9 (1.3)	8.9" (225)	0.9" (22)	1/4" 	25 (720)
AG058A-10-Q	15 – 40 (1.7 – 4.5)	25 – 60 (2.8 – 6.8)	35 – 80 (4.0 – 9.0)	1,000	2.9 (1.3)	8.9" (225)	0.9" (22)	1/4" 	25 (720)
AG058A-8-Q	15 – 40 (1.7 – 4.5)	25 – 60 (2.8 – 6.8)	35 – 100 (4.0 – 11.3)	800	2.9 (1.3)	8.9" (225)	0.9" (22)	1/4" 	25 (720)

Series			
50	80 dBa	1/4" NPT	5/16" (8 mm)

QRT Series

Unique Quick Reverse Touch Control (QRT) trigger makes this the ideal tool when single-hand control of speed and rotation is required.

Features

- Torque range: 3 – 100 in-lbs (0.34 – 11.3 Nm)
- Speeds: 800 – 2,600 rpm
- Simple two-finger reverse control
- Ideal for applications that require frequent reversing or realignment
- Operates as trigger + push-to-start tool in forward rotation
- Reverse trigger provides instant full-power reverse
- Recommended for applications where precise torque control is required

Service and Accessories

Manuals:

- 49999013 20 Series
- 49999054 50 Series

Accessories:

- Torque arm: QTA010
- Spring balancers: BLD2
- Spindle accessories, see page 183



Model	in-lbs (Nm)	in-lbs (Nm)	in-lbs (Nm)	rpm	lbs (kg)	in (mm)	in (mm)	in	cfm (L/min)
20 SERIES QRT TRIGGER + PUSH-TO-START									
SQ024C-26-Q	3.0 – 10 (0.34 – 1.1)	–	–	2,600	1.9 (0.8)	7.1" (180)	0.8" (19)	1/4"	15 (420)
SQ024C-15-Q	3.0 – 10 (0.34 – 1.1)	8.0 – 20 (0.9 – 2.3)	–	1,500	2.0 (0.9)	7.5" (191)	0.8" (19)	1/4"	15 (420)
SQ024C-9-Q	3.0 – 10 (0.34 – 1.1)	8.0 – 20 (0.9 – 2.3)	10 – 30 (1.1 – 3.4)	900	2.0 (0.9)	7.5" (191)	0.8" (19)	1/4"	15 (420)
SQ024C-8-Q	4.0 – 13 (0.50 – 1.5)	10 – 26 (1.1–2.9)	12 – 40 (1.4 – 4.5)	800	2.0 (0.9)	7.5" (191)	0.8" (19)	1/4"	15 (420)
50 SERIES QRT TRIGGER + PUSH-TO-START									
SQ054C-16-Q	15 – 40 (1.7 – 4.5)	25 – 60 (2.8 – 6.8)	–	1,600	3.2 (1.4)	8.8" (224)	0.9" (24)	1/4"	25 (720)
SQ054C-10-Q	15 – 40 (1.7 – 4.5)	25 – 60 (2.8 – 6.8)	35 – 80 (4.0 – 9.0)	1,000	3.2 (1.4)	8.8" (224)	0.9" (24)	1/4"	25 (720)
SQ054C-8-Q	15 – 40 (1.7 – 4.5)	25 – 60 (2.8 – 6.8)	35 – 100 (4.0 – 11.3)	800	3.2 (1.4)	8.8" (224)	0.9" (24)	1/4"	25 (720)

Series			
20 Series QRT	79 dBa	1/4" NPT	5/16" (8 mm)
50 Series QRT	78 dBa	1/4" NPT	5/16" (8 mm)

Pistol Grip Air Screwdrivers

Adjustable Shut-Off Clutch

41 Series



Time-tested design known for its durability and performance.

Features

- Torque range: 15 – 100 in-lbs (1.7 – 11.3 Nm)
- Speeds: 800 – 2,400 rpm
- Skinsulate housing provides comfortable grip surface
- One-handed reverse lever
- Recommended for applications where precise torque control is required

Service and Accessories

Manuals:

-  16574592
-  80167356
-  16575284

Accessories:

- Torque arm: QTA010
- Horizontal hanger: 48934
- Dead handle: 48931
- Spring balancer, see page 177
- Spindle accessories, see page 183
- Top air inlet kit (push-to-start): 48995













41PA10TSQ4

Adjustable Shut-Off Clutch

Kits:

- Mechanism kit: 48804-1

Model	in-lbs (Nm)	in-lbs (Nm)	in-lbs (Nm)	rpm	lbs (kg)	in (mm)	in (mm)	in	cfm (L/min)
DC TRIGGER START									
41PA24TSQ4	15 – 40 (1.7 – 4.5)	–	–	2,400	2.9 (1.3)	9.4" (239)	0.9" (22)	1/4" 	28 (790)
41PA16TSQ4	15 – 40 (1.7 – 4.5)	25 – 60 (2.8 – 6.8)	–	1,600	3.1 (1.4)	9.8" (249)	0.9" (22)	1/4" 	28 (790)
41PA10TSQ4	15 – 40 (1.7 – 4.5)	25 – 60 (2.8 – 6.8)	35 – 80 (4.0 – 9.0)	1,000	3.1 (1.4)	9.8" (249)	0.9" (22)	1/4" 	28 (790)
41PA8TSQ4	15 – 40 (1.7 – 4.5)	25 – 60 (2.8 – 6.8)	35 – 100 (4.0 – 11.3)	800	3.1 (1.4)	9.8" (249)	0.9" (22)	1/4" 	28 (790)
DC PUSH-TO-START									
41PA24PSQ4	15 – 40 (1.7 – 4.5)	–	–	2,400	2.9 (1.3)	9.4" (239)	0.9" (22)	1/4" 	28 (790)
41PA16PSQ4	15 – 40 (1.7 – 4.5)	25 – 60 (2.8 – 6.8)	–	1,600	3.1 (1.4)	9.8" (249)	0.9" (22)	1/4" 	28 (790)
41PA10PSQ4	15 – 40 (1.7 – 4.5)	25 – 60 (2.8 – 6.8)	35 – 80 (4.0 – 9.0)	1,000	3.1 (1.4)	9.8" (249)	0.9" (22)	1/4" 	28 (790)
41PA8PSQ4	15 – 40 (1.7 – 4.5)	25 – 60 (2.8 – 6.8)	35 – 100 (4.0 – 11.3)	800	3.1 (1.4)	9.8" (249)	0.9" (22)	1/4" 	28 (790)
DC TRIGGER + PUSH-TO-START									
41PA16TPQ4	15 – 40 (1.7 – 4.5)	25 – 60 (2.8 – 6.8)	–	1,600	3.0 (1.36)	9.8" (249)	0.9" (22)	1/4" 	28 (790)
41PA10TPQ4	15 – 40 (1.7 – 4.5)	25 – 60 (2.8 – 6.8)	35 – 80 (4.0 – 9.0)	1,000	3.1 (1.4)	9.8" (249)	0.9" (22)	1/4" 	28 (790)
41PA8TPQ4	15 – 40 (1.7 – 4.5)	25 – 60 (2.8 – 6.8)	35 – 100 (4.0 – 11.3)	800	3.1 (1.4)	9.8" (249)	0.9" (22)	1/4" 	28 (790)

Series			
41	78 dBa	1/4" NPT	5/16" (8 mm)

Pistol Grip Air Screwdrivers

Adjustable Cushion Clutch

1 Series



Time-tested design provides repeatable results day in and day out at an economical price.

Features

- Torque range: 1.5 – 30 in-lbs (0.2 – 3.4 Nm)
- Speeds: 1,000 – 1,650 rpm
- Compact and lightweight
- Coated grip for operator comfort
- Recommended for applications that require a torque limiting clutch

Service and Accessories

Manuals:

-  16574550
-  80167265



Accessories:

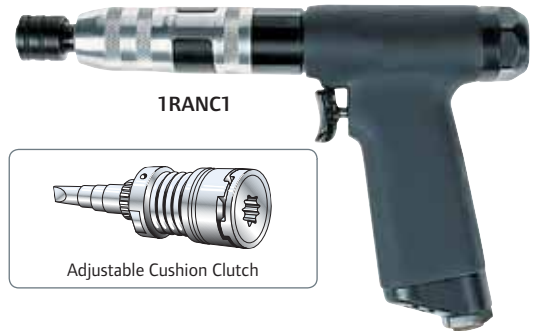

- Torque arm: QTA010
- Spring balancer, see page 177
- Spindle accessories, see page 183
- Hanger: 3RA-365

Kits:

- Tune-up kit: 3RA-TK2



Model	in-lbs (Nm)	in-lbs (Nm)	in-lbs (Nm)	rpm	lbs (kg)	in (mm)	in (mm)	in	cfm (L/min)
TRIGGER + PUSH-TO-START									
1RAMC1	2.5 – 15.9 (0.3 – 1.8)	6.2 – 20.4 (0.7 – 2.3)	–	1,650	1.5 (0.7)	8.5" (217)	0.7" (17)	1/4" 	13 (368)
1RANC1	1.5 – 15.9 (0.2 – 1.8)	4.4 – 23.0 (0.5 – 2.6)	9.7 – 30.1 (1.1 – 3.4)	1,000	1.5 (0.7)	8.5" (217)	0.7" (17)	1/4" 	13 (368)

Series			
1	73 dBa	1/8" NPT	1/4" (6 mm)

Pistol Grip Air Screwdrivers

Adjustable Cushion Clutch

20 & 50 Series



Legendary performance in a compact, lightweight package with a well-deserved reputation for durability.

Features

- Torque Range: 4 – 100 in-lbs (0.5 – 11.3 Nm)
- Speeds: 800 – 2,600 rpm
- Skinsulate housing provides comfortable grip surface
- One-handed reverse lever
- Recommended for applications that require a torque limiting clutch

Service and Accessories

Manuals:

	49999035	20 Series
	49999093	50 Series

Accessories (20 Series and 50 Series):

Torque arm: QTA010
 Spring balancer, see page 177
 Spindle accessories, see page 183
 Suspension bail (20 Series): 47795
 Suspension bail (50 Series): 46472

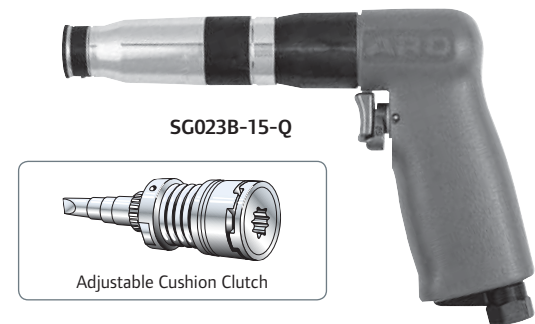



SG023B-15-Q

Adjustable Cushion Clutch

Kits:

Service kit (20 Series): 46992
 Service kit (50 Series): 47353

Model	in-lbs (Nm)	in-lbs (Nm)	in-lbs (Nm)	rpm	lbs (kg)	in (mm)	in (mm)	in	cfm (L/min)
20 SERIES TRIGGER START									
SG023B-26-Q	4.0 – 12 (0.5 – 1.4)	–	–	2,600	1.7 (0.8)	6.6" (169)	0.7" (17)	1/4"	15 (420)
SG023B-15-Q	4.0 – 20 (0.5 – 2.3)	–	–	1,500	1.8 (0.8)	7.0" (178)	0.7" (17)	1/4"	15 (420)
SG023B-9-Q	4.0 – 20 (0.5 – 2.3)	20 – 30 (2.3 – 3.4)	–	900	1.8 (0.8)	7.0" (178)	0.7" (17)	1/4"	15 (420)
50 SERIES TRIGGER START									
SG053B-25-Q	10 – 40 (1.1 – 4.5)	–	–	2,500	2.9 (1.4)	8.9" (226)	0.8" (21)	1/4"	25 (720)
SG053B-17-Q	10 – 40 (1.1 – 4.5)	15 – 60 (1.7 – 6.8)	–	1,700	3.1 (1.5)	9.4" (238)	0.8" (21)	1/4"	25 (720)
SG053B-10-Q	10 – 40 (1.1 – 4.5)	15 – 80 (1.7 – 9.0)	–	1,000	3.1 (1.5)	9.4" (238)	0.8" (21)	1/4"	25 (720)
SG053B-8-Q	10 – 40 (1.1 – 4.5)	15 – 80 (1.7 – 9.0)	45 – 100 (5.1 – 11.3)	800	3.1 (1.5)	9.4" (238)	0.8" (21)	1/4"	25 (720)

Series			
20	76 dBa	1/4" NPT	5/16" (8 mm)
50	78 dBa	1/4" NPT	5/16" (8 mm)

Q2 Series



Sets the standard for assembly tool ergonomics.

Features

- Torque range: 2.7 – 47.8 in-lbs (0.3 – 5.4 Nm)
- Speeds: 250 – 2,000 rpm
- Compact, lightweight, well-balanced design
- Contoured soft grip handle
- Two-finger trigger distributes grip force and reduces stress
- Interchangeable handles offer custom fit for various hand sizes
- Top or bottom air inlets allow for optimal mounting
- Recommended for applications that require a torque limiting clutch

Service and Accessories

Manuals:

-  16574527
-  80165939
-  16575219











Accessories:

- Horizontal hanger: TRP-A365
- Torque arm: QTA010
- Spring balancers, see page 177
- Spindle accessories, see page 183

Kits:

- Inlet / throttle / motor tune-up kit: Q2-PFAST-TK1
- Cushion clutch kit: Q2-CC-TK1



Model	in-lbs (Nm)	in-lbs (Nm)	in-lbs (Nm)	rpm	lbs (kg)	in (mm)	in (mm)	in	cfm (L/min)
TRIGGER START									
QP1S10C1D	2.7 – 9.7 (0.3 – 1.1)	8.0 – 22.1 (0.9 – 2.5)	13.3 – 39.8 (1.5 – 4.5)	1,000	1.9 (0.8)	8.8" (223)	0.6" (15)	1/4" 	16 (450)
QP1S10C1TD*	2.7 – 9.7 (0.3 – 1.1)	8.0 – 22.1 (0.9 – 2.5)	13.3 – 39.8 (1.5 – 4.5)	1,000	1.9 (0.8)	8.8" (223)	0.6" (15)	1/4" 	16 (450)
QP1S05C1D	2.7 – 9.7 (0.3 – 1.1)	8.0 – 28.3 (0.9 – 3.2)	13.3 – 47.8 (1.5 – 5.4)	500	1.9 (0.8)	8.8" (223)	0.6" (15)	1/4" 	16 (450)
QP1S05C1TD*	2.7 – 9.7 (0.3 – 1.1)	8.0 – 28.3 (0.9 – 3.2)	13.3 – 47.8 (1.5 – 5.4)	500	1.9 (0.8)	8.8" (223)	0.6" (15)	1/4" 	16 (450)
QP1S02C1TD*	2.7 – 9.7 (0.3 – 1.1)	8.0 – 28.3 (0.9 – 3.2)	13.3 – 47.8 (1.5 – 5.4)	250	1.9 (0.8)	8.8" (223)	0.6" (15)	1/4" 	16 (450)
PUSH-TO-START									
QP1P20C1D	2.7 – 9.7 (0.3 – 1.1)	8.0 – 22.1 (0.9 – 2.5)	–	2,000	1.9 (0.8)	8.8" (223)	0.6" (15)	1/4" 	16 (450)
QP1P10C1D	2.7 – 9.7 (0.3 – 1.1)	8.0 – 22.1 (0.9 – 2.5)	13.3 – 39.8 (1.5 – 4.5)	1,000	1.9 (0.8)	8.8" (223)	0.6" (15)	1/4" 	16 (450)
QP1P05C1D	2.7 – 9.7 (0.3 – 1.1)	8.0 – 28.3 (0.9 – 3.2)	13.3 – 47.8 (1.5 – 5.4)	500	1.9 (0.8)	8.8" (223)	0.6" (15)	1/4" 	16 (450)
TRIGGER + PUSH-TO-START									
QP1T10C1D	2.7 – 9.7 (0.3 – 1.1)	8.0 – 22.1 (0.9 – 2.5)	13.3 – 39.8 (1.5 – 4.5)	1,000	1.9 (0.8)	8.8" (223)	0.6" (15)	1/4" 	16 (450)
QP1T10C1TD*	2.7 – 9.7 (0.3 – 1.1)	8.0 – 22.1 (0.9 – 2.5)	13.3 – 39.8 (1.5 – 4.5)	1,000	1.9 (0.8)	8.8" (223)	0.6" (15)	1/4" 	16 (450)

*Top air inlet.

Series			
Q2	75 dBa	1/4" NPT	1/4" (6 mm)

Pistol Grip Air Screwdrivers

Adjustable Cushion Clutch

41 Series

Time-tested design known for its durability and performance.

Features

- Torque range: 10 – 100 in-lbs (1.1 – 11.3 Nm)
- Speeds: 800 – 2,500 rpm
- Skinsulate housing provides comfortable grip surface
- One-handed reverse lever
- Recommended for applications that require a torque limiting clutch

Service and Accessories

Manuals:

 P7098US

Accessories:

Torque arm: QTA010
Horizontal hanger: 48934
Dead handle: 48931
Spring balancer, see page 177
Spindle accessories, see page 183





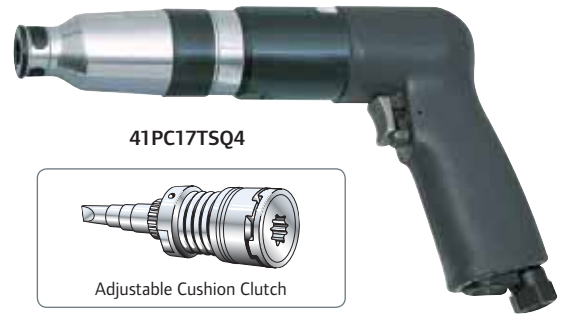







Kits:

Mechanism kit: 48804-1



41PC17TSQ4

Adjustable Cushion Clutch

Model	 in-lbs (Nm)	 in-lbs (Nm)	 in-lbs (Nm)	 rpm	 lbs (kg)	 in (mm)	 in (mm)	 in	 cfm (L/min)
TRIGGER START									
41PC25TSQ4	10 – 39.8 (1.1 – 4.5)	–	–	2,500	2.8 (1.3)	8.9" (226)	0.8" (20)	1/4" 	20 (565)
41PC17TSQ4	10 – 39.8 (1.1 – 4.5)	15 – 53.1 (1.7 – 6.0)	–	1,700	3.1 (1.4)	9.4" (239)	0.8" (20)	1/4" 	20 (565)
41PC10TSQ4	10 – 39.8 (1.1 – 4.5)	15 – 79.7 (1.7 – 9.0)	–	1,000	3.1 (1.4)	9.4" (239)	0.8" (20)	1/4" 	20 (565)
41PC8TSQ4	10 – 39.8 (1.1 – 4.5)	15 – 79.7 (1.7 – 9.0)	45.1 – 100 (5.1 – 11.3)	800	3.1 (1.4)	9.4" (239)	0.8" (20)	1/4" 	20 (565)

Series			
41	78 dBa	1/4" NPT	5/16" (8 mm)

5 & 7 Series



Durability and performance are the hallmarks of these proven winners.



Features

- Torque range: 13.3 – 110 in-lbs (1.5 – 12.5 Nm)
- Speeds: 900 – 2,000 rpm
- One-handed reverse lever
- Recommended for applications that require a torque limiting clutch

Service and Accessories

Manuals:

-  16574576 5 Series
-  80167273

-  16574584 7 Series
-  80167299
-  16575276















Accessories:

- Torque arm: QTA010
- Horizontal hanger: 7RA-A366
- Dead handle: 728N-A48 (5 Series only), requires (2) 5A-49
- Dead handle: R1A-A48 (7 Series only), requires (2) 7A-49
- Spring balancer, see page 177
- Spindle accessories, see page 183

Kits:

- Tune-up kit (5 Series): 5RA/5RL-TK1



Model	 in-lbs (Nm)	 in-lbs (Nm)	 in-lbs (Nm)	 rpm	 lbs (kg)	 in (mm)	 in (mm)	 in	 cfm (L/min)
5C 5 SERIES TRIGGER START									
5RALC1	13.3 – 35.4 (1.5 – 4.0)	–	–	2,000	2.6 (1.2)	8.8" (223)	0.8" (21)	1/4" 	17 (480)
5RALC3	13.3 – 35.4 (1.5 – 4.0)	–	–	2,000	2.6 (1.2)	9.0" (229)	0.8" (21)	1/4" 	17 (480)
5RANC1	13.3 – 54.9 (1.5 – 6.2)	54.9 – 70.8 (6.2 – 8.0)	–	900	2.9 (1.3)	9.5" (241)	0.8" (21)	1/4" 	17 (480)
5C 7 SERIES TRIGGER START									
7RALC1	15 – 55.4 (1.7 – 6.3)	15 – 75.2 (1.7 – 8.5)	–	1,800	3.1 (1.4)	10.0" (254)	0.9" (23)	1/4" 	27 (760)
7RAMC1	20.4 – 85.9 (2.3 – 9.7)	25.7 – 110.6 (2.9 – 12.5)	–	1,000	3.3 (1.5)	10.6" (268)	0.9" (23)	1/4" 	27 (760)

Series			
5	75 dBa	1/4" NPT	1/4" (6 mm)
7	79 dBa	1/4" NPT	5/16" (8 mm)

Pistol Grip Air Screwdrivers

Adjustable Cushion Clutch

QRT Series

Unique Quick Reverse Touch Control (QRT) trigger makes this the ideal tool when single-hand control of speed and rotation is required.

Features

- Torque range: 8.0 – 70.0 in-lbs (0.9 – 7.9 Nm)
- Speeds: 600 – 2,100 rpm
- Simple two-finger forward / reverse control
- Ideal for applications that require frequent reversing or realignment
- Operates as trigger + push-to-start tool in forward rotation
- Reverse trigger provides instant full-power reverse
- Recommended for applications that require a torque limiting clutch

Service and Accessories

Manuals:

49999032

Accessories:

Torque arm: QTA010
Spring balancer: BLD2
Spindle accessories, see page 183

Kits:

Service kit: 42114

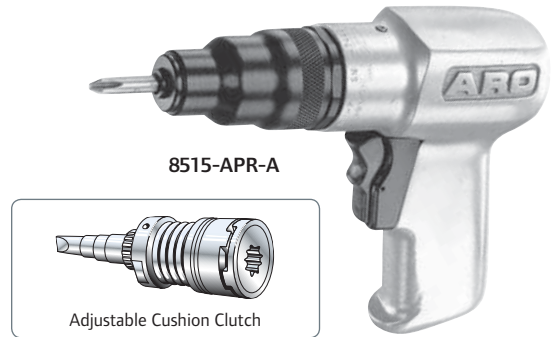

Model	in-lbs (Nm)	rpm	lbs (kg)	in (mm)	in (mm)	in	cfm (L/min)
TRIGGER + PUSH-TO-START							
8521-APR-A	8 – 40 (0.9 – 4.5)	2,100	2.5 (1.1)	7.5" (190)	0.9" (23)	1/4"	27 (762)
8515-APR-A	8 – 45 (0.9 – 5.1)	1,500	2.5 (1.1)	7.5" (190)	0.9" (23)	1/4"	27 (762)
8509-APR-A	8 – 50 (0.9 – 5.7)	900	3.1 (1.4)	8.9" (226)	0.9" (23)	1/4"	26 (732)
8506-APR-A	8 – 70 (0.9 – 7.9)	600	3.1 (1.4)	8.9" (226)	0.9" (23)	1/4"	24 (678)

Series			
QRT	82 dBa	1/4" NPT	5/16" (8 mm)

Pistol Grip Air Screwdrivers

Positive Jaw

20 & 50 Series

Legendary performance in a compact, lightweight package with a well-deserved reputation for durability.

Features

- Torque range: 12 – 120 in-lbs (1.4 – 13.6 Nm)
- Speeds: 800 – 2,600 rpm
- Skinsulate housing provides comfortable grip surface
- One-handed reverse lever
- Torque adjusted by limiting air pressure
- Recommended for applications that require more driving torque than final seating torque

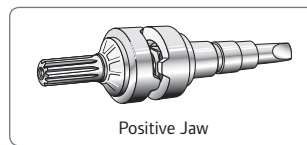

Service and Accessories

Manuals:

- 49999035 20 Series
- 49999093 50 Series
- 49999096 Woodworking screwdriver

Accessories:

- Torque arm: QTA010
- Suspension bail (20 Series): 47795
- Suspension bail (50 Series): 46472
- Spring balancer, see page 177
- Spindle accessories, see page 183

Kits:

- Service kit (20 Series): 46992
- Service kit (50 Series): 47353

Model	in-lbs (Nm)	rpm	lbs (kg)	in (mm)	in (mm)	in	cfm (L/min)
20 SERIES TRIGGER START							
SG022B-26-Q	12 (1.4)	2,600	1.5 (0.7)	5.1" (131)	0.7" (17)	1/4"	15 (420)
SG022B-15-Q	25 (2.8)	1,500	1.6 (0.7)	5.5" (140)	0.7" (17)	1/4"	15 (420)
SG022B-9-Q	38 (4.3)	900	1.6 (0.7)	5.5" (140)	0.7" (17)	1/4"	15 (420)
50 SERIES ANGLE JAW TRIGGER START							
SG052B-25-Q	45 (5.1)	2,500	2.4 (1.1)	7.2" (182)	0.8" (21)	1/4"	25 (720)
SG052B-17-Q	65 (7.3)	1,700	2.6 (1.2)	7.6" (194)	0.8" (21)	1/4"	25 (720)
SG052B-10-Q	90 (10.2)	1,000	2.6 (1.2)	7.6" (194)	0.8" (21)	1/4"	25 (720)
SG052B-8-Q	120 (13.6)	800	2.6 (1.2)	7.6" (194)	0.8" (21)	1/4"	25 (720)
50 SERIES 90 DEGREE JAW TRIGGER START							
SG059B-17-Q	65 (7.3)	1,700	2.6 (1.2)	7.6" (194)	0.8" (21)	1/4"	25 (720)
SG059B-10-Q	90 (10.2)	1,000	2.6 (1.2)	7.6" (194)	0.8" (21)	1/4"	25 (720)
SG059B-8-Q	120 (13.6)	800	2.6 (1.2)	7.6" (194)	0.8" (21)	1/4"	25 (720)
TRIGGER START WOODWORKING SCREWDRIVER							
7672-A18	74 (8.4)	1,800	2.6 (1.2)	6.6" (169)	0.9" (22)	1/4"	27 (720)

Series			
20	76 dBa	1/4" NPT	5/16" (8 mm)
50	78 dBa	1/4" NPT	5/16" (8 mm)

Series			
Woodworking	78 dBa	1/4" NPTF	5/16" (8mm)

Pistol Grip Air Screwdrivers

Positive Jaw

QRT Series



Unique Quick Reverse Touch Control (QRT) trigger makes this the ideal tool when single-hand control of speed and rotation is required.

Features

- Torque range: 40 – 110 in-lbs (1.1 – 12.5 Nm)
- Speeds: 600 – 2,100 rpm
- Simple two-finger reverse control
- Ideal for applications that require frequent reversing or realignment
- Operates as trigger + push-to-start tool in forward rotation
- Recommended for applications that require more driving torque than final seating torque

Service and Accessories

Manuals:

	49999183	000 Series
	49999032	0 Series









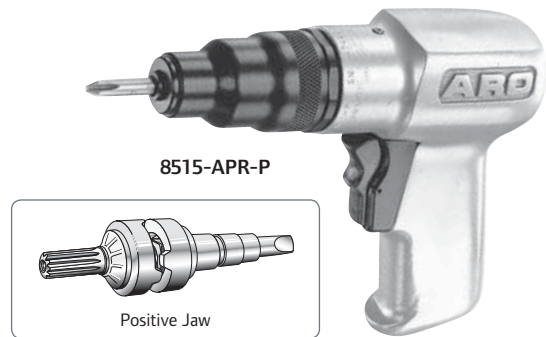



Accessories (000 Series and 0 Series):



Torque arm: QTA010
Spring balancer: BLD2
Spindle accessories, see page 183

Kits:

Service kit (0 Series): 42341



							
Model	in-lbs (Nm)	rpm	lbs (kg)	in (mm)	in (mm)	in	cfm (L/min)
000 QRT SERIES TRIGGER START							
8683-BPR-P	50 (5.7)	750	2.0 (0.9)	7.1" (179)	0.8" (20)	1/4" 	17 (480)
0 QRT SERIES TRIGGER START							
8521-APR-P	45 (5.1)	2,100	2.2 (1.0)	6.8" (173)	0.9" (23)	1/4" 	27 (762)
8515-APR-P	50 (5.7)	1,500	2.9 (1.3)	8.2" (208)	0.9" (23)	1/4" 	27 (762)
8509-APR-P	80 (9.1)	900	2.9 (1.3)	8.2" (208)	0.9" (23)	1/4" 	26 (732)
8506-APR-P	110 (12.5)	600	2.9 (1.3)	8.2" (208)	0.9" (23)	1/4" 	24 (678)

Series			
000	82 dBa	1/4" NPT	5/16" (8 mm)
0	82 dBa	1/4" NPT	5/16" (8 mm)

41 Series

Time-tested design known for its durability and performance.

Features

- Torque range: 45 – 120 in-lbs (5.1 – 13.6 Nm)
- Speeds: 800 – 2,500 rpm
- Skinsulate housing provides comfortable grip surface
- One-handed reverse lever
- Torque adjusted by limiting air pressure
- Recommended for applications that require more driving torque than final seating torque

Service and Accessories

Manuals:

 P7098

Accessories:

- Horizontal hanger: 48934
- Dead handle: 48931
- Torque arm: QTA010
- Spring balancer, see page 177
- Spindle accessories, see page 183











Kits:

Mechanism kit: 48804-1



41PP25TSQ4

Positive Jaw

							
Model	in-lbs (Nm)	rpm	lbs (kg)	in (mm)	in (mm)	in	cfm (L/min)
DC TRIGGER START							
41PP25TSQ4	45.1 (5.1)	2,500	2.2 (1.0)	7.2" (183)	0.8" (20)	1/4" 	20 (565)
41PP17TSQ4	64.6 (7.3)	1,700	2.4 (1.1)	7.6" (193)	0.8" (20)	1/4" 	20 (565)
41PP10TSQ4	90.3 (10.2)	1,000	2.4 (1.1)	7.6" (193)	0.8" (20)	1/4" 	20 (565)
41PP8TSQ4	120.4 (13.6)	800	2.4 (1.1)	7.6" (193)	0.8" (20)	1/4" 	20 (565)

Series			
41	78 dBa	1/4" NPT	5/16" (8 mm)

Pistol Grip Air Screwdrivers

Positive Jaw

5 & 7 Series



Durability and performance are the hallmarks of these proven winners.

Features

- Torque range: 35.4 – 166.4 in-lbs (4.0 – 18.8 Nm)
- Speeds: 700 – 2,000 rpm
- One-handed reverse lever
- Torque adjusted by limiting air pressure
- Recommended for applications that require more driving torque than final seating torque

Service and Accessories

Manuals:

-  16574576 5 Series
-  80167273
-  16574584 7 Series
-  16575276









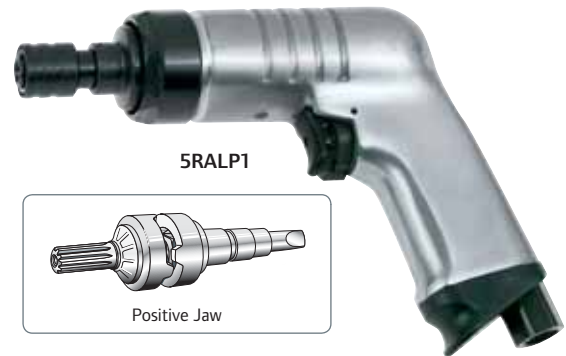

Accessories:

Torque arm: QTA010
 Dead handle: 728N-A48 (5 Series only), requires (2) 5A-49
 Dead handle: R1A-A48 (7 Series only), requires (2) 7A-49
 Spring balancer, see page 177
 Spindle accessories, see page 183

Kits:

Tune-up kit (5 Series): 5RA/5RL-TK1



							
Model	in-lbs (Nm)	rpm	lbs (kg)	in (mm)	in (mm)	in	cfm (L/min)
DC 5 SERIES TRIGGER START							
5RALP1	35.4 (4.0)	2,000	1.9 (0.9)	7.2" (184)	0.8" (21)	1/4" 	17 (480)
5RANP1	70.8 (8.0)	900	2.2 (1.0)	8.0" (203)	0.8" (21)	1/4" 	17 (480)
DC 7 SERIES TRIGGER START							
7RAMP1	115.9 (13.1)	1,000	3.1 (1.4)	9.3" (237)	0.9" (22)	1/4" 	27 (760)
7RANP1	166.4 (18.8)	700	3.1 (1.4)	9.3" (237)	0.9" (22)	1/4" 	27 (760)

Series			
5	75 dBa	1/4" NPT	1/4" (6 mm)
7	79 dBa	1/4" NPT	5/16" (8 mm)

Pistol Grip Air Screwdrivers

Stall

Q2 Series

Compact design handles tight clearance applications with ease.

Features

- Torque range: 25.7 – 86.7 in-lbs (2.9 – 9.8 Nm)
- Speeds: 500 – 2,000 rpm
- Compact, lightweight, well-balanced design
- Contoured soft grip handle
- Two-finger trigger distributes grip force and reduces stress
- Interchangeable handles offer custom fit for various hand sizes
- Top or bottom air inlets allow for optimal mounting
- Recommended for soft-draw applications in wood or other materials not requiring critical torque control

Service and Accessories

Manuals:

- 16574527
- 80165939

Accessories:

- Torque arm: QTA010
- Spring balancer, see page 177
- Spindle accessories, see page 183
- Horizontal hanger: TRP-A365

Kits:

- Inlet / throttle / motor tune-up kit: Q2-PFAST-TK1



Model	in-lbs (Nm)	rpm	lbs (kg)	in (mm)	in (mm)	in	cfm (L/min)
TRIGGER START							
QP1S20D1D	25.7 (2.9)	2000	1.5 (0.7)	6.4" (162)	0.6" (15)	1/4"	16 (450)
QP1S20D1TD*	25.7 (2.9)	2000	1.5 (0.7)	6.4" (162)	0.6" (15)	1/4"	16 (450)
QP1S15D1D	30.1 (3.4)	1500	1.5 (0.7)	6.4" (162)	0.6" (15)	1/4"	16 (450)
QP1S15D1TD*	30.1 (3.4)	1500	1.5 (0.7)	6.4" (162)	0.6" (15)	1/4"	16 (450)
QP1S10D1D	46 (5.2)	1000	1.5 (0.7)	6.4" (162)	0.6" (15)	1/4"	16 (450)
QP1S10D1TD*	46 (5.2)	1000	1.5 (0.7)	6.4" (162)	0.6" (15)	1/4"	16 (450)
QP1S05D1D	86.7 (9.8)	500	1.5 (0.7)	6.4" (162)	0.6" (15)	1/4"	16 (450)
QP1S05D1TD*	86.7 (9.8)	500	1.5 (0.7)	6.4" (162)	0.6" (15)	1/4"	16 (450)

*Top air inlet.

Series			
Q2	75 dBa	1/4" NPT	1/4" (6 mm)

Pistol Grip Air Screwdrivers

Stall

20 & 50 Series

Legendary performance in a compact, lightweight package with a well-deserved reputation for durability.

Features

- Torque range: 12 – 120 in-lbs (1.4 – 13.6 Nm)
- Speeds: 800 – 2,600 rpm
- Skinsulate housing provides comfortable grip surface
- One-handed reverse lever
- Torque adjusted by limiting air pressure
- Recommended for soft pull applications not requiring critical torque control

Service and Accessories

Manuals:

	49999035	20 Series
	49999093	50 Series









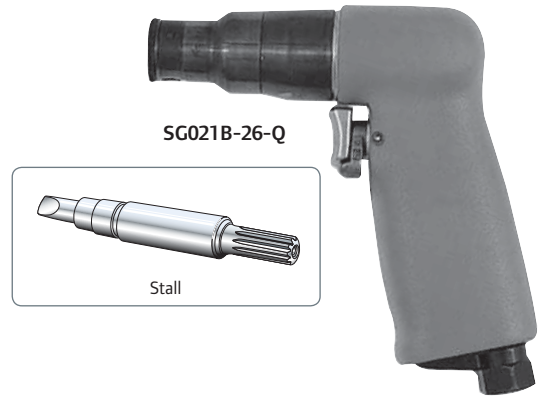





Accessories (20 Series and 50 Series):

Torque arm: QTA010
 Dead handle: 728N-A48
 Spring balancer, see page 177
 Spindle accessories, see page 183
 Suspension bail (20 Series): 47795
 Suspension bail (50 Series): 46472

Kits:

Service kit (20 Series): 46992
 Service kit (50 Series): 47353



Model	 in-lbs (Nm)	 rpm	 lbs (kg)	 in (mm)	 in (mm)	 in	 cfm (L/min)
20 SERIES TRIGGER START							
SG021B-26-Q	12 (1.4)	2,600	1.3 (0.6)	4.6" (118)	0.7" (17)	1/4" 	15 (420)
SG021B-15-Q	25 (2.8)	1,500	1.4 (0.6)	5.0" (128)	0.7" (17)	1/4" 	15 (420)
SG021B-9-Q	38 (4.3)	900	1.4 (0.6)	5.0" (128)	0.7" (17)	1/4" 	15 (420)
50 SERIES TRIGGER START							
SG051B-25-Q	45 (4.0)	2,500	2.2 (1.0)	6.9" (175)	0.8" (21)	1/4" 	25 (720)
SG051B-17-Q	65 (7.3)	1,700	2.4 (1.1)	7.4" (187)	0.8" (21)	1/4" 	25 (720)
SG051B-10-Q	90 (10.2)	1,000	2.4 (1.1)	7.4" (187)	0.8" (21)	1/4" 	25 (720)
SG051B-8-Q	120 (13.6)	800	2.4 (1.1)	7.4" (187)	0.8" (21)	1/4" 	25 (720)

Series			
20	76 dBa	1/4" NPT	5/16" (8 mm)
50	78 dBa	1/4" NPT	5/16" (8 mm)

5 & 7 Series



Durability and performance are the hallmarks of these proven winners.



Features

- Torque range: 35.4 – 70.8 in-lbs (4.0 – 8.0 Nm)
- Speeds: 900 – 2,000 rpm
- One-handed reverse lever
- Torque adjusted by limiting air pressure
- Recommended for soft-draw applications in wood or other materials not requiring critical torque control

Service and Accessories

Manuals:

-  16574576 5 Series
-  80167273

-  16574584 7 Series
-  80167299
-  16575276

Accessories (5 Series):

- Horizontal hanger: 7RA-A366
- Dead handle: 728N-A48, requires (2) 5A-49
- Horizontal hanger: R1A-A48 (7 Series only), requires (2) 7A-49
- Torque arm: QTA010



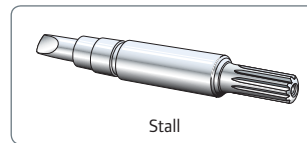







5RALD1



Stall

Kits:

- Tune-up kit (5 Series): 5RA/5RL-TK1

							
Model	in-lbs (Nm)	rpm	lbs (kg)	in (mm)	in (mm)	in	cfm (L/min)
5C 5 SERIES TRIGGER START							
5RALD1	35.4 (4.0)	2,000	1.9 (0.9)	7.2" (184)	0.8" (21)	1/4" 	17 (480)
5RAND1	70.8 (8.0)	900	2.1 (1.0)	8.0" (203)	0.8" (21)	1/4" 	17 (480)
5C 7 SERIES TRIGGER START							
7RALD1	70.8 (8.0)	1,800	2.8 (1.3)	8.6" (219)	0.9" (23)	1/4" 	27 (765)

Series			
5	75 dBa	1/4" NPT	1/4" (6 mm)
7	79 dBa	1/4" NPT	5/16" (8 mm)

Pistol Grip Air Screwdrivers

Stall

41 Series

Time-tested design known for its durability and performance.

Features

- Torque range: 45 – 120 in-lbs (5.1 – 13.6 Nm)
- Speeds: 800 – 2,500 rpm
- Skinsulate housing provides comfortable grip surface
- One-handed reverse lever
- Torque adjusted by limiting air pressure
- Recommended for soft-draw applications in wood or other materials not requiring critical torque control

Service and Accessories

Manuals:

 P7098





Accessories:

Horizontal hanger: 48934
 Dead handle: 48931
 Torque arm: QTA010
 Spring balancer, see page 177
 Spindle accessories, see page 183

Kits:

Mechanism kit: 48804-1



Model	in-lbs (Nm)	rpm	lbs (kg)	in (mm)	in (mm)	in	cfm (L/min)
DC TRIGGER START							
41PD25TSQ4	45.1 (5.1)	2,500	2.1 (1.0)	6.9" (176)	0.8" (20)	1/4" 	20 (565)
41PD17TSQ4	64.6 (7.3)	1,700	2.2 (1.0)	7.4" (188)	0.8" (20)	1/4" 	20 (565)
41PD10TSQ4	90.3 (10.2)	1,000	2.2 (1.0)	7.4" (188)	0.8" (20)	1/4" 	20 (565)
41PD8TSQ4	120.4 (13.6)	800	2.2 (1.0)	7.4" (188)	0.8" (20)	1/4" 	20 (565)

Series			
41	78 dBa	1/4" NPT	5/16" (8 mm)

QRT Series

Unique Quick Reverse Touch Control (QRT) trigger makes this the ideal tool when single hand control of speed and rotation is required.

Features

- Torque Range: 15 – 110 in-lbs (1.7 – 12.5 Nm)
- Speeds: 600 – 2,300 rpm
- Simple two-finger reverse control
- Ideal for applications that require frequent reversing or realignment
- Recommended for soft-draw applications in wood or other materials not requiring critical torque control

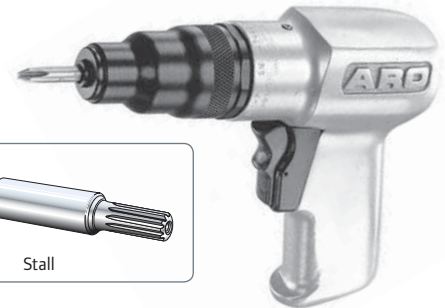
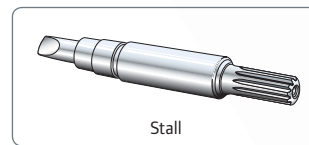

Service and Accessories

Manuals:













	49999183	000 Series
	49999032	0 Series

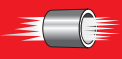

Accessories (000 Series and 0 Series):

Torque arm: QTA010
Spring balancer: BLD2
Spindle accessories, see page 183

Kits:

Service kit (0 Series): 42122-2

							
Model	in-lbs (Nm)	rpm	lbs (kg)	in (mm)	in (mm)	in	cfm (L/min)
DC 000 SERIES TRIGGER START							
8684-BPR-D	15 (1.7)	2,300	1.3 (0.6)	4.8" (123)	0.8" (20)	1/4" 	23 (648)
8683-BPR-D	50 (5.7)	750	1.6 (0.7)	6.0" (152)	0.8" (20)	1/4" 	17 (480)
DC 0 SERIES TRIGGER START							
8521-BPR-D	45 (5.1)	2,100	2.2 (1.0)	6.8" (173)	0.9" (23)	1/4" 	27 (762)
8515-BPR-D	50 (5.7)	1,500	2.8 (1.3)	8.2" (208)	0.9" (23)	1/4" 	27 (762)
8509-BPR-D	80 (9.1)	900	2.8 (1.3)	8.2" (208)	0.9" (23)	1/4" 	26 (732)
8506-BPR-D	110 (12.5)	600	2.8 (1.3)	8.2" (208)	0.9" (23)	1/4" 	24 (678)

Series			
000 QRT	82 dBa	1/4" NPT	5/16" (8 mm)
0 QRT	82 dBa	1/4" NPT	5/16" (8 mm)

Inline Air Screwdrivers

Adjustable Shut-Off Clutch

1 Series

Time-tested design provides repeatable results day in and day out at an economical price.

Features

- Torque range: 3.7 – 45.1 in-lbs (0.3 – 5.1 Nm)
- Speeds: 500 – 2,800 rpm
- Compact and lightweight
- Coated grip for operator comfort
- Simple push-button reverse
- Recommended for joints where precise torque control is required



1RPQS1

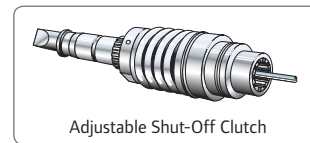

Adjustable Shut-Off Clutch

Service and Accessories

Manuals:

- 16574550
- 80167265

Accessories:

- Torque reaction arm: QTA010
- Spring balancer: BLD1
- Spindle accessories, see page 183

Kits:

- Reversible motor kit: 0-TK2

Model	in-lbs (Nm)	in-lbs (Nm)	in-lbs (Nm)	rpm	lbs (kg)	in (mm)	in (mm)	in	cfm (L/min)
DC LEVER START									
IRLNS1	2.7 – 15.9 (0.3 – 1.8)	4.4 – 23 (0.5 – 2.6)	9.7 – 30.1 (1.1 – 3.4)	1,000	1.1 (0.5)	9.2" (234)	0.6" (14)	1/4"	13 (368)
DC PUSH-TO-START									
IRPLS1	4.4 – 13.3 (0.5 – 1.5)	-	-	2,800	1.1 (0.5)	8.4" (213)	0.6" (14)	1/4"	13 (368)
IRPMS1	4.4 – 15.9 (0.5 – 1.8)	6.2 – 20.4 (0.7 – 2.3)	-	1,650	1.1 (0.5)	8.7" (222)	0.6" (14)	1/4"	13 (368)
IRPNS1	2.7 – 15.9 (0.3 – 1.8)	4.4 – 23 (0.5 – 2.6)	9.7 – 30.1 (1.1 – 3.4)	1,000	1.1 (0.5)	8.7" (222)	0.6" (14)	1/4"	13 (368)
IRPQS1	2.7 – 15.9 (0.3 – 1.8)	4.4 – 23 (0.5 – 2.6)	8.9 – 45.1 (1.0 – 5.1)	500	1.1 (0.5)	8.7" (222)	0.7" (17)	1/4"	13 (368)

Series			
1	73 dBA	1/8" NPT	1/4" (6 mm)

Inline Air Screwdrivers

Adjustable Shut-Off Clutch

Q2 Series



Sets the standard for assembly tool ergonomics.

Features

- Torque range: 2.7 – 47.8 in-lbs (0.3 – 5.4 Nm)
- Speeds: 250 – 2,000 rpm
- Compact, lightweight, well-balanced design
- Egg-shaped housing employs a natural fit
- Soft-grip surface over molded on a composite core provides a comfortable texture and temperature
- Recommended for joints where precise torque control is required

Service and Accessories

Manuals:

-  16574501, 16574493
-  80165921
-  16575185, 16575193

Accessories:

- Spring balancer, see page 177
- Workstation, see page 182
- Spindle accessories, see page 183
- Piped away exhaust kit: LG1-K284





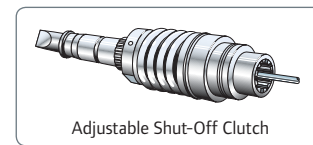









QS1P20S1D



Adjustable Shut-Off Clutch

Kits:















- ASO tune-up kit: Q2-ASO-TK1
- Inlet / throttle / motor tune-up kit: Q2-TK1

Model	in-lbs (Nm)	in-lbs (Nm)	in-lbs (Nm)	rpm	lbs (kg)	in (mm)	in (mm)	in	cfm (L/min)
DC LEVER START									
QS1L20S1D	2.7 – 9.7 (0.3 – 1.1)	8.0 – 22.1 (0.9 – 2.5)	–	2,000	1.5 (0.7)	9.5" (241)	0.9" (22)	1/4" 	16 (450)
QS1L15S1D	2.7 – 9.7 (0.3 – 1.1)	8.0 – 27.4 (0.9 – 3.1)	–	1,500	1.5 (0.7)	9.5" (241)	0.9" (22)	1/4" 	16 (450)
QS1L10S1D	2.7 – 9.7 (0.3 – 1.1)	8.0 – 22.1 (0.9 – 2.5)	13.3 – 39.8 (1.5 – 4.5)	1,000	1.5 (0.7)	9.5" (241)	0.9" (22)	1/4" 	16 (450)
QS1L05S1D	2.7 – 9.7 (0.3 – 1.1)	8.0 – 28.3 (0.9 – 3.2)	13.3 – 47.8 (1.5 – 5.4)	500	1.5 (0.7)	9.5" (241)	0.9" (22)	1/4" 	16 (450)
QS1L02S1D	2.7 – 9.7 (0.3 – 1.1)	8.0 – 28.3 (0.9 – 3.2)	13.3 – 47.8 (1.5 – 5.4)	250	1.5 (0.7)	9.5" (241)	0.9" (22)	1/4" 	16 (450)
DC PUSH-TO-START									
QS1P20S1D	2.7 – 9.7 (0.3 – 1.1)	8.0 – 22.1 (0.9 – 2.5)	–	2,000	1.4 (0.6)	8.8" (223)	0.9" (22)	1/4" 	16 (450)
QS1P15S1D	2.7 – 9.7 (0.3 – 1.1)	8.0 – 27.4 (0.9 – 3.1)	–	1,500	1.4 (0.6)	8.8" (223)	0.9" (22)	1/4" 	16 (450)
QS1P10S1D	2.7 – 9.7 (0.3 – 1.1)	8.0 – 22.1 (0.9 – 2.5)	13.3 – 39.8 (1.5 – 4.5)	1,000	1.4 (0.6)	8.8" (223)	0.9" (22)	1/4" 	16 (450)
QS1P05S1D	2.7 – 9.7 (0.3 – 1.1)	8.0 – 28.3 (0.9 – 3.2)	13.3 – 47.8 (1.5 – 5.4)	500	1.4 (0.6)	8.8" (223)	0.9" (22)	1/4" 	16 (450)
QS1P02S1D	2.7 – 9.7 (0.3 – 1.1)	8.0 – 28.3 (0.9 – 3.2)	13.3 – 47.8 (1.5 – 5.4)	250	1.4 (0.6)	8.8" (223)	0.9" (22)	1/4" 	16 (450)
QS1P15S3D	2.7 – 9.7 (0.3 – 1.1)	8.0 – 27.4 (0.9 – 3.1)	–	1,500	1.4 (0.6)	8.8" (223)	0.9" (22)	1/4" 	16 (450)
QS1P10S3D	2.7 – 9.7 (0.3 – 1.1)	8.0 – 22.1 (0.9 – 2.5)	13.3 – 39.8 (1.5 – 4.5)	1,000	1.4 (0.6)	8.8" (223)	0.9" (22)	1/4" 	16 (450)
QS1P05S3D	2.7 – 9.7 (0.3 – 1.1)	8.0 – 28.3 (0.9 – 3.2)	13.3 – 47.8 (1.5 – 5.4)	500	1.4 (0.6)	8.8" (223)	0.9" (22)	1/4" 	16 (450)

(continued next page)

Series			
Q2	75 dBA	1/4" NPT	1/4" (6 mm)

Q2 Series (continued)

									
Model	in-lbs (Nm)	in-lbs (Nm)	in-lbs (Nm)	rpm	lbs (kg)	in (mm)	in (mm)	in	cfm (L/min)
DC LEVER + PUSH-TO-START									
QS1T20S1D	2.7 – 9.7 (0.3 – 1.1)	8.0 – 22.1 (0.9 – 2.5)	–	2,000	1.5 (0.7)	9.5" (241)	0.9" (22)	1/4" 	16 (450)
QS1T15S1D	2.7 – 9.7 (0.3 – 1.1)	8.0 – 27.4 (0.9 – 3.1)	–	1,500	1.5 (0.7)	9.5" (241)	0.9" (22)	1/4" 	16 (450)
QS1T10S1D	2.7 – 9.7 (0.3 – 1.1)	8.0 – 22.1 (0.9 – 2.5)	13.3 – 39.8 (1.5 – 4.5)	1,000	1.5 (0.7)	9.5" (241)	0.9" (22)	1/4" 	16 (450)
QS1T05S1D	2.7 – 9.7 (0.3 – 1.1)	8.0 – 28.3 (0.9 – 3.2)	13.3 – 47.8 (1.5 – 5.4)	500	1.5 (0.7)	9.5" (241)	0.9" (22)	1/4" 	16 (450)
QS1T02S1D	2.7 – 9.7 (0.3 – 1.1)	8.0 – 28.3 (0.9 – 3.2)	13.3 – 47.8 (1.5 – 5.4)	250	1.5 (0.7)	9.5" (241)	0.9" (22)	1/4" 	16 (450)

Series			
Q2	75 dBA	1/4" NPT	1/4" (6 mm)

Inline Air Screwdrivers

Adjustable Shut-Off Clutch

20 & 50 Series



Legendary performance in a compact, lightweight package with a well-deserved reputation for durability.

Features

- Torque range: 3.0 – 100 in-lbs (0.34 – 11.3 Nm)
- Speeds: 800 – 2,600 rpm
- Skinsulate housing provides comfortable grip surface on push-to-start models
- Simple push-button reverse
- Recommended for joints where precise torque control is required

Service and Accessories

Manuals:

-  49999035 20 Series
-  49999246
-  49999093 50 Series

Accessories:







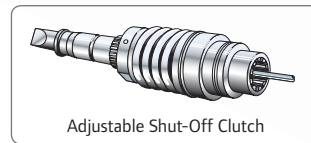





- Torque arm: QTA010
- Spring balancer, see page 177
- Spindle accessories, see page 183
- Workstation, see page 182
- Dead handle: 48931 (50 Series only)
- Piped away exhaust kit: 5L-K184



AS028A-15-Q



Adjustable Shut-Off Clutch

Model	in-lbs (Nm)	in-lbs (Nm)	in-lbs (Nm)	rpm	lbs (kg)	in (mm)	in (mm)	in	cfm (L/min)
20 SERIES PUSH-TO-START									
SA024C-26-Q	3.0 – 10 (0.34 – 1.1)	–	–	2,600	1.2 (0.5)	8.3" (210)	0.6" (15)	1/4" 	15 (420)
SA024C-15-Q	3.0 – 10 (0.34 – 1.1)	8.0 – 20 (0.9 – 2.3)	–	1,500	1.3 (0.6)	8.6" (219)	0.6" (15)	1/4" 	15 (420)
SA024C-9-Q	3.0 – 10 (0.34 – 1.1)	8.0 – 20 (0.9 – 2.3)	10 – 30 (1.1 – 3.4)	900	1.3 (0.6)	8.6" (219)	0.6" (15)	1/4" 	15 (420)
SA024C-8-Q	4.0 – 13 (0.5 – 1.5)	10 – 26 (1.1 – 2.9)	12 – 40 (1.4 – 4.5)	800	1.3 (0.6)	8.6" (219)	0.6" (15)	1/4" 	15 (420)
20 SERIES LEVER + PUSH-TO-START									
AS028A-15-Q	3.0 – 10 (0.34 – 1.1)	8.0 – 20 (0.9 – 2.3)	–	1,500	1.5 (0.7)	9.5" (240)	0.6" (15)	1/4" 	15 (420)
AS028A-9-Q	3.0 – 10 (0.34 – 1.1)	8.0 – 20 (0.9 – 2.3)	10 – 30 (1.1 – 3.4)	900	1.5 (0.7)	9.5" (240)	0.6" (15)	1/4" 	15 (420)
AS028A-8-Q	4.0 – 13 (0.5 – 1.5)	10 – 26 (1.1 – 2.9)	12 – 40 (1.4 – 4.5)	800	1.5 (0.7)	9.5" (240)	0.6" (15)	1/4" 	15 (420)
50 SERIES PUSH-TO-START									
SA054C-17-Q	15 – 40 (1.7 – 4.5)	25 – 60 (2.8 – 6.8)	–	1,700	2.8 (1.3)	10.3" (260)	0.9" (22)	1/4" 	25 (720)
SA054C-10-Q	15 – 40 (1.7 – 4.5)	25 – 60 (2.8 – 6.8)	35 – 80 (4.0 – 9.0)	1,000	2.8 (1.3)	10.3" (260)	0.9" (22)	1/4" 	25 (720)
SA054C-8-Q	15 – 40 (1.7 – 4.5)	25 – 60 (2.8 – 6.8)	35 – 100 (4.0 – 11.3)	800	2.8 (1.3)	10.3" (260)	0.9" (22)	1/4" 	25 (720)
50 SERIES LEVER + PUSH-TO-START									
AS058A-10-Q	15 – 40 (1.7 – 4.5)	25 – 60 (2.8 – 6.8)	35 – 80 (4.0 – 9.0)	1,000	3.0 (1.4)	10.9" (278)	0.9" (22)	1/4" 	25 (720)
AS058A-8-Q	15 – 40 (1.7 – 4.5)	25 – 60 (2.8 – 6.8)	35 – 100 (4.0 – 11.3)	800	3.0 (1.4)	10.9" (278)	0.9" (22)	1/4" 	25 (720)

Series			
20	76 dBA	1/4" NPT	5/16" (8mm)
50	80 dBA	1/4" NPT	5/16" (8mm)

41 Series



Time-tested design known for its durability and performance.

Features

- Torque range: 15 – 100 in-lbs (1.7 – 11.3 Nm)
- Speeds: 800 – 2500 rpm
- Skinsulate housing provides a comfortable grip surface, requiring less force and pressure during operation
- Simple push-button reverse
- Recommended for joints where precise torque control is required

Service and Accessories

Manuals:

-  80167356
-  16575284

Accessories:

- Bail: 46328
- Spring balancer: BLD2
- Torque reaction arm: QTA010
- Dead handle: 48931
- Spindle accessories, see page 183

Kits:







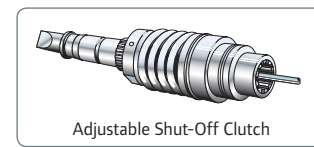







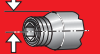

- Mechanism tune-up kit: 48804-1



41SA10PSQ4



Adjustable Shut-Off Clutch

Model	 in-lbs (Nm)	 in-lbs (Nm)	 in-lbs (Nm)	 rpm	 lbs (kg)	 in (mm)	 in (mm)	 in	 cfm (L/min)
DC PUSH-TO-START									
41SA17PSQ4	15 – 39.8 (1.7 – 4.5)	24.8 – 60.2 (2.8 – 6.8)	–	1,700	2.7 (1.2)	10.9" (277)	0.8" (20)	1/4" 	30 (850)
41SA10PSQ4	15 – 39.8 (1.7 – 4.5)	24.8 – 60.2 (2.8 – 6.8)	35.4 – 79.7 (4.0 – 9.0)	1,000	2.7 (1.2)	10.9" (277)	0.8" (20)	1/4" 	30 (850)
41SA8PSQ4	15 – 39.8 (1.7 – 4.5)	24.8 – 60.2 (2.8 – 6.8)	35.4 – 100 (4.0 – 11.3)	800	2.7 (1.2)	10.9" (277)	0.8" (20)	1/4" 	30 (850)
DC LEVER + PUSH-TO-START									
41SA25LPQ4	15 – 40 (1.7 – 4.5)	–	–	2,500	2.5 (1.1)	10.4" (264)	0.8" (20)	1/4" 	30 (850)
41SA17LPQ4	15 – 39.9 (1.7 – 4.5)	24.8 – 60.2 (2.8 – 6.8)	–	1,700	2.7 (1.2)	10.9" (277)	0.8" (20)	1/4" 	30 (850)
41SA10LPQ4	15 – 39.8 (1.7 – 4.5)	24.8 – 60.2 (2.8 – 6.8)	35.4 – 79.7 (4.0 – 9.0)	1,000	2.7 (1.2)	10.9" (277)	0.8" (20)	1/4" 	28 (790)
41SA8LPQ4	15 – 39.8 (1.7 – 4.5)	24.8 – 60.2 (2.8 – 6.8)	35.4 – 100 (4.0 – 11.3)	800	2.7 (1.2)	10.9" (277)	0.8" (20)	1/4" 	28 (790)

Series			
41	78 dBA	1/4" NPT	5/16" (8 mm)

Inline Air Screwdrivers

Adjustable Cushion Clutch

1 Series

Time-tested design provides repeatable results day in and day out at an economical price.



1RPMC1

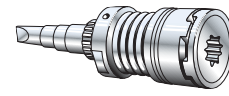

Adjustable Cushion Clutch

Features

- Torque range: 2.7 – 30.1 in-lbs (0.3 – 3.4 Nm)
- Speeds: 1,000 – 1,650 rpm
- Compact and lightweight
- Coated grip for operator comfort
- Simple push-button reverse
- Recommended for joints that require a torque limiting clutch

Service and Accessories

Manuals:



16574550



80167265

Accessories:

Torque reaction arm: QTA010
Spring balancer: BLD1
Spindle accessories, see page 183

Kits:

Motor tune-up kit: 0-TK2

Model	in-lbs (Nm)	in-lbs (Nm)	in-lbs (Nm)	rpm	lbs (kg)	in (mm)	in (mm)	in	cfm (L/min)
LEVER START									
1RLMC1	4.4 – 15.9 (0.5 – 1.8)	6.2 – 20.4 (0.7 – 2.3)	–	1,650	1.1 (0.5)	8.7" (222)	0.6" (14)	1/4"	13 (368)
1RLNC1	2.7 – 15.9 (0.3 – 1.8)	4.4 – 23.0 (0.5 – 2.6)	9.7 – 30.1 (1.1 – 3.4)	1,000	1.1 (0.5)	8.7" (222)	0.6" (14)	1/4"	13 (368)
PUSH-TO-START									
1RPMC1	4.4 – 15.9 (0.5 – 1.8)	6.2 – 20.4 (0.7 – 2.3)	–	1,650	1.1 (0.5)	8.7" (222)	0.6" (14)	1/4"	13 (368)
1RPNC1	2.7 – 15.9 (0.3 – 1.8)	4.4 – 23.0 (0.5 – 2.6)	9.7 – 30.1 (1.1 – 3.4)	1,000	1.1 (0.5)	8.7" (222)	0.6" (14)	1/4"	13 (368)

Series			
1	73 dBA	1/8" NPT	1/4" (6 mm)

Q2 Series

Sets the standard for assembly tool ergonomics.

Features

- Torque range: 3.0 – 47.8 in-lbs (0.3 - 5.4 Nm)
- Speeds: 250 – 2,800 rpm
- Compact, lightweight, well-balanced design
- Egg-shaped housing employs a natural fit
- Soft-grip surface over molded on a composite core provides a comfortable texture and temperature
- Recommended for joints that require a torque limiting clutch



QS1P10C1D

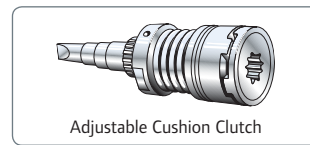

Adjustable Cushion Clutch

Service and Accessories

Manuals:

- 16574493, 16574501
- 80165921
- 16575185, 16575193

Accessories:

- Spring balancer: see page 177
- Piped away exhaust kit: LG1-K284
- Workstation, see page 182
- Spindle accessories, see page 183

Kits:

- QS inlet / throttle / motor tune-up kit: Q2-TK1
- Cushion clutch kit: Q2-CC-TK1

Model	in-lbs (Nm)	in-lbs (Nm)	in-lbs (Nm)	rpm	lbs (kg)	in (mm)	in (mm)	in	cfm (L/min)
OC LEVER START									
QS1L28C1D	3.0 – 9.7 (0.3 – 1.1)	–	–	2,800	1.5 (0.7)	9.5" (241)	0.9" (22)	1/4"	16 (450)
QS1L20C1D	3.0 – 9.7 (0.3 – 1.1)	8.0 – 22.1 (0.9 – 2.5)	–	2,000	1.5 (0.7)	9.5" (241)	0.9" (22)	1/4"	16 (450)
QS1L15C1D	3.0 – 9.7 (0.3 – 1.1)	8.0 – 22.1 (0.9 – 2.5)	–	1,500	1.5 (0.7)	9.5" (241)	0.9" (22)	1/4"	16 (450)
QS1L10C1D	3.0 – 9.7 (0.3 – 1.1)	8.0 – 22.1 (0.9 – 2.5)	13.3 – 40 (1.5 – 4.52)	1,000	1.5 (0.7)	9.5" (241)	0.9" (22)	1/4"	16 (450)
QS1L10C3D	3.0 – 9.7 (0.3 – 1.1)	8.0 – 22.1 (0.9 – 2.5)	13.3 – 40 (1.5 – 4.52)	1,000	1.5 (0.7)	9.5" (241)	0.9" (22)	1/4"	16 (450)
QS1L05C1D	3.0 – 9.7 (0.3 – 1.1)	8.0 – 28.3 (0.9 – 3.2)	13.3 – 47.8 (1.5 – 5.4)	500	1.5 (0.7)	9.5" (241)	0.9" (22)	1/4"	16 (450)
OC PUSH-TO-START									
QS1P28C1D	3.0 – 9.7 (0.3 – 1.1)	–	–	2,800	1.4 (0.6)	8.8" (223)	0.9" (22)	1/4"	16 (450)
QS1P20C1D	3.0 – 9.7 (0.3 – 1.1)	8.0 – 22.1 (0.9 – 2.5)	–	2,000	1.4 (0.6)	8.8" (223)	0.9" (22)	1/4"	16 (450)
QS1P15C1D	3.0 – 9.7 (0.3 – 1.1)	8.0 – 22.1 (0.9 – 2.5)	–	1,500	1.4 (0.6)	8.8" (223)	0.9" (22)	1/4"	16 (450)
QS1P10C1D	3.0 – 9.7 (0.3 – 1.1)	8.0 – 22.1 (0.9 – 2.5)	13.3 – 40.0 (1.5 – 4.5)	1,000	1.4 (0.6)	8.8" (223)	0.9" (22)	1/4"	16 (450)
QS1P05C1D	3.0 – 9.7 (0.3 – 1.1)	8.0 – 28.3 (0.9 – 3.2)	13.3 – 47.8 (1.5 – 5.4)	500	1.4 (0.6)	8.8" (223)	0.9" (22)	1/4"	16 (450)

Series			
Q2	75 dBA	1/4" NPT	1/4" (6 mm)

Inline Air Screwdrivers

Adjustable Cushion Clutch

20 & 50 Series

Legendary performance in a compact, lightweight package with a well-deserved reputation for durability.

Features

- Torque range: 4 – 100 in-lbs (0.5 – 11.3 Nm)
- Speeds: 800 – 2,600 rpm
- Skinsulate housing provides comfortable grip surface
- Simple push-button reverse
- Recommended for assembling that requires a torque limiting clutch

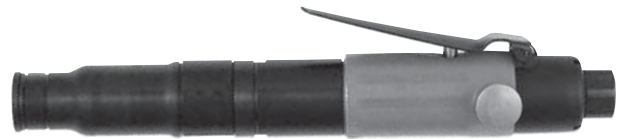

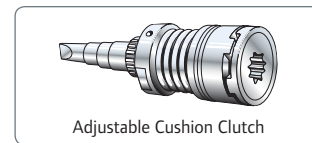

SL023B-15-Q



Adjustable Cushion Clutch

Service and Accessories

Manuals:















-  49999035 20 Series
-  49999093 50 Series

Accessories:

Torque reaction arm: QTA010
Spring balancer, see page 177
Spindle accessories, see page 183
Piped away exhaust kit: 5L-K184

Kits:

20 Series tune-up kit: 46992
50 Series tune-up kit: 47353

Model	in-lbs (Nm)	in-lbs (Nm)	in-lbs (Nm)	rpm	lbs (kg)	in (mm)	in (mm)	in	cfm (L/min)
20 SERIES LEVER START									
SL023B-26-Q	-	4.0 – 12 (0.5 – 1.4)	-	2,600	1.2 (0.5)	8.2" (208)	0.6" (15)	1/4" 	15 (420)
SL023B-15-Q	-	4.0 – 20 (0.5 – 2.3)	-	1,500	1.3 (0.6)	8.5" (217)	0.6" (15)	1/4" 	15 (420)
SL023B-9-Q	-	4.0 – 20 (0.5 – 2.3)	20 – 30 (2.3 – 3.4)	900	1.3 (0.6)	8.5" (217)	0.6" (15)	1/4" 	15 (420)
20 SERIES PUSH-TO-START									
SA023B-26-Q	-	4.0 – 12 (0.5 – 1.4)	-	2,600	1.2 (0.5)	8.2" (208)	0.6" (15)	1/4" 	15 (420)
SA023B-15-Q	-	4.0 – 20 (0.5 – 2.3)	-	1,500	1.3 (0.6)	8.5" (217)	0.6" (15)	1/4" 	15 (420)
SA023B-9-Q	-	4.0 – 20 (0.5 – 2.3)	20 – 30 (2.3 – 3.4)	900	1.3 (0.6)	8.5" (217)	0.6" (15)	1/4" 	15 (420)
50 SERIES LEVER START									
SL053B-25-Q	10 – 40 (1.1 – 4.5)	-	-	2,500	2.9 (1.4)	10.4" (264)	0.8" (21)	1/4" 	25 (720)
SL053B-17-Q	10 – 40 (1.1 – 4.5)	15 – 60 (1.7 – 6.8)	-	1,700	3.1 (1.5)	10.9" (277)	0.8" (21)	1/4" 	25 (720)
SL053B-10-Q	10 – 40 (1.1 – 4.5)	15 – 80 (1.7 – 9.0)	-	1,000	3.1 (1.5)	10.9" (277)	0.8" (21)	1/4" 	25 (720)
SL053B-8-Q	10 – 40 (1.1 – 4.5)	15 – 80 (1.7 – 9.0)	45 – 100 (5.1 – 11.3)	800	3.1 (1.5)	10.9" (277)	0.8" (21)	1/4" 	25 (720)
50 SERIES PUSH-TO-START									
SA053B-25-Q	10 – 40 (1.1 – 4.5)	-	-	2,500	2.6 (1.2)	10.4" (264)	0.8" (21)	1/4" 	25 (720)
SA053B-17-Q	10 – 40 (1.1 – 4.5)	15 – 60 (1.7 – 6.8)	-	1,700	2.8 (1.3)	10.9" (277)	0.8" (21)	1/4" 	25 (720)
SA053B-10-Q	10 – 40 (1.1 – 4.5)	15 – 80 (1.7 – 9.0)	-	1,000	2.8 (1.3)	10.9" (277)	0.8" (21)	1/4" 	25 (720)
SA053B-8-Q	10 – 40 (1.1 – 4.5)	15 – 80 (1.7 – 9.0)	45 – 100 (5.1 – 11.3)	800	2.8 (1.3)	10.9" (277)	0.8" (21)	1/4" 	25 (720)

Series			
20	76 dBA	1/4" NPT	5/16" (8mm)
50	78 dBA	1/4" NPT	5/16" (8mm)

41 Series

Time-tested design known for its durability and performance.

Features

- Torque range: 10 – 100 in-lbs (1.1 – 11.3 Nm)
- Speeds: 800 – 2,500 rpm
- Skinsulate housing provides a comfortable grip surface, requiring less force and pressure during operation
- Simple push-button reverse
- Recommended for assembling that requires a torque limiting clutch



41SC10LTQ4

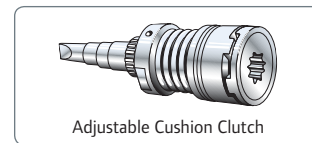

Adjustable Cushion Clutch

Service and Accessories

Manuals:

- 80167356
- 16575284

Accessories:

- Torque arm, see page 180
- Spring balancer, see page 177
- Spindle accessories, see page 183
- Dead handle: 48931
- Bail: 46328

Kits:

- Mechanism tune-up kit: 48804-1

Model	in-lbs (Nm)	in-lbs (Nm)	in-lbs (Nm)	rpm	lbs (kg)	in (mm)	in (mm)	in	cfm (L/min)
DC LEVER START									
41SC25LTQ4	9.7 – 39.8 (1.1 – 4.5)	–	–	2,500	2.9 (1.3)	10.4" (264)	0.8" (20)	1/4"	20 (565)
41SC17LTQ4	9.7 – 39.8 (1.1 – 4.5)	15 – 60.2 (1.7 – 6.8)	–	1,700	3.1 (1.4)	10.9" (277)	0.8" (20)	1/4"	20 (565)
41SC10LTQ4	9.7 – 39.8 (1.1 – 4.5)	15 – 79.7 (1.7 – 9.0)	–	1,000	3.1 (1.4)	10.9" (277)	0.8" (20)	1/4"	20 (565)
41SC8LTQ4	9.7 – 39.8 (1.1 – 4.5)	15 – 79.7 (1.7 – 9.0)	45 – 100 (5.1 – 11.3)	800	3.1 (1.4)	10.9" (277)	0.8" (20)	1/4"	20 (565)
DC PUSH-TO-START									
41SC25PSQ4	9.7 – 39.8 (1.1 – 4.5)	–	–	2,500	2.8 (1.3)	10.4" (264)	0.8" (20)	1/4"	20 (565)
41SC17PSQ4	9.7 – 39.8 (1.1 – 4.5)	15 – 60.2 (1.7 – 6.8)	–	1,700	3.1 (1.4)	10.9" (277)	0.8" (20)	1/4"	20 (565)
41SC10PSQ4	9.7 – 39.8 (1.1 – 4.5)	15 – 79.7 (1.7 – 9.0)	–	1,000	3.1 (1.4)	10.9" (277)	0.8" (20)	1/4"	20 (565)
41SC8PSQ4	9.7 – 39.8 (1.1 – 4.5)	15 – 79.7 (1.7 – 9.0)	45 – 100 (5.1 – 11.3)	800	3.1 (1.4)	10.9" (277)	0.8" (20)	1/4"	20 (565)

Series			
41	78 dBA	1/4" NPT	5/16" (8 mm)

Inline Air Screwdrivers

Adjustable Cushion Clutch

5 & 7 Series







Durability and performance are the hallmarks of these proven winners.

Features

- Torque range: 13 – 110 in-lbs (1.5 – 12.5 Nm)
- Speeds: 1,000 – 2,100 rpm
- Simple push-button reverse
- External torque adjustments with no tool disassembly required
- Recommended for assembly that requires a torque limiting clutch

Service and Accessories

Manuals:

	16574576	5 Series
	80167273	
	16575276	
	16574584	7 Series
	80167299	
	16575276	

Accessories:

Dead handle: 728N-A48 (5 Series only) requires (2) 5A-49,
R1A-A48 (7 Series only) requires (2) 7A-49
Suspension bail: 5RL-365 (5 Series only),
7L-365 (7 Series only)
Piped away exhaust kit: 5L-K184 (5 Series only),
7L-K284 (7 Series only)
Torque arm, see page 180
Spindle accessories, see page 183
Spring balancer, see page 177

Kits:





Mechanism tune-up kit (7 Series): 6RL-S/D-A/T-TK1

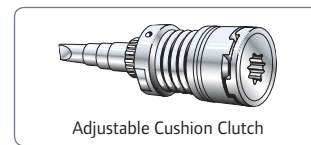



7RLMC1



Adjustable Cushion Clutch

Model	in-lbs (Nm)	in-lbs (Nm)	in-lbs (Nm)	rpm	lbs (kg)	in (mm)	in (mm)	in	cfm (L/min)
5 SERIES LEVER START									
5RLLC1	13 – 35 (1.5 – 4.0)	–	–	2,100	2.6 (1.1)	10.0" (254)	0.8" (21)	1/4" 	16 (460)
5RLNC1	13 – 54 (1.5 – 6.3)	55 – 75 (6.3 – 8.5)	–	1,000	2.9 (1.3)	10.7" (273)	0.8" (21)	1/4" 	16 (460)
5RLNC3	13 – 54 (1.5 – 6.3)	55 – 75 (6.3 – 8.5)	–	1,000	2.9 (1.3)	11.0" (279)	0.8" (21)	1/4" 	16 (460)
7 SERIES LEVER START									
7RLLC1	15 – 55 (1.7 – 6.3)	15 – 75 (1.7 – 8.5)	–	2,100	2.9 (1.3)	11.3" (287)	0.9" (22)	1/4" 	27 (762)
7RLMC1	20 – 85 (2.3 – 9.7)	25 – 110 (2.8 – 12.5)	–	1,200	3.1 (1.4)	11.9" (302)	0.9" (22)	1/4" 	27 (762)

Series			
5	75 dBA	1/4" NPT	1/4" (6 mm)
7	79 dBA	1/4" NPT	5/16" (8 mm)

Inline Air Screwdrivers

Positive Jaw

20 & 50 Series



Legendary performance in a compact, lightweight package with a well-deserved reputation for durability.

Features

- Torque range: 25 – 120 in-lbs (2.8 – 13.6 Nm)
- Speeds: 800 – 2,500 rpm
- Skinsulate housing provides comfortable grip surface
- Simple push-button reverse
- Recommended for assembly that requires more driving torque than final seating torque

Service and Accessories

Manuals:

	49999035	20 Series
	49999093	50 Series

Accessories:

Dead handle: 48931 (50 Series only)
 Suspension bail: 5RL-365
 Piped away exhaust kit: 5L-K184
 Torque arm: QTA010
 Spindle accessories, see page 183

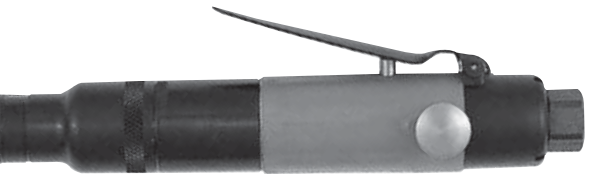



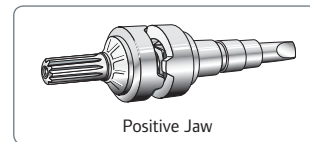









SL022B-9-Q



Positive Jaw

Kits:

20 Series tune-up kit: 46992
 50 Series tune-up kit: 47353

							
Model	in-lbs (Nm)	rpm	lbs (kg)	in (mm)	in (mm)	in	cfm (L/min)
20 SERIES ANGLE JAW							
SL022B-15-Q	25 (2.8)	1,500	1.1 (0.5)	7.0" (178)	0.6" (15)	1/4" 	15 (420)
SL022B-9-Q	38 (4.3)	900	1.1 (0.5)	7.0" (178)	0.6" (15)	1/4" 	15 (420)
50 SERIES ANGLE JAW							
SL052B-25-Q	45 (4.0)	2,500	2.4 (1.1)	8.6" (219)	0.8" (21)	1/4" 	25 (720)
SL052B-17-Q	65 (7.3)	1,700	2.6 (1.2)	9.1" (232)	0.8" (21)	1/4" 	25 (720)
SL052B-10-Q	90 (10.2)	1,000	2.6 (1.2)	9.1" (232)	0.8" (21)	1/4" 	25 (720)
SL052B-8-Q	120 (13.6)	800	2.6 (1.2)	9.1" (232)	0.8" (21)	1/4" 	25 (720)

Series			
20	76 dBA	1/4" NPT	5/16" (8mm)
50	78 dBA	1/4" NPT	5/16" (8mm)

Inline Air Screwdrivers

Positive Jaw

41 Series

Time-tested design known for its durability and performance.

Features

- Torque range: 45 – 120 in-lbs (5.1 – 13.6 Nm)
- Speeds: 800 – 2,500 rpm
- Skinsulate housing provides a comfortable grip surface, requiring less force and pressure during operation
- Simple push-button reverse
- Recommended for assembly that requires more driving torque than final seating torque

Service and Accessories

Manuals:

- 80167356
- 16575284

Accessories:

- Torque reaction arm: QTA010
- Dead handle: 48931
- Suspension bail: 46328
- Spring balancer, see page 177
- Spindle accessories, see page 183



Kits:

- Mechanism tune-up kit: 48804-1

Model	in-lbs (Nm)	rpm	lbs (kg)	in (mm)	in (mm)	in	cfm (L/min)
DC LEVER START							
41SP25LTQ4	45 (5.1)	2,500	2.2 (1.0)	8.6" (218)	0.8" (20)	1/4"	20 (565)
41SP17LTQ4	65 (7.3)	1,700	2.4 (1.1)	9.1" (231)	0.8" (20)	1/4"	20 (565)
41SP10LTQ4	90 (10.2)	1,000	2.4 (1.1)	9.1" (231)	0.8" (20)	1/4"	20 (565)
41SP8LTQ4	120 (13.6)	800	2.4 (1.1)	9.1" (231)	0.8" (20)	1/4"	20 (565)

Series			
41	78 dBA	1/4" NPT	5/16" (8 mm)

Inline Air Screwdrivers

Stall

20 & 50 Series

Legendary performance in a compact, lightweight package with a well-deserved reputation for durability.

Features

- Torque range: 12 – 120 in-lbs (1.5 – 13.6 Nm)
- Speeds: 800 – 2,600 rpm
- Skinsulate housing provides comfortable grip surface
- Simple push-button reverse
- Recommended for soft pull applications not requiring critical torque control

Service and Accessories

Manuals:

- 49999035 20 Series
- 49999093 50 Series

Accessories:

- Dead handle: 48931 (50 Series only)
- Torque arm: QTA010
- Spring balancers, see page 177
- Spindle accessories, see page 183
- Suspension bail: 5RL-365
- Piped away exhaust kit: 5L-K184

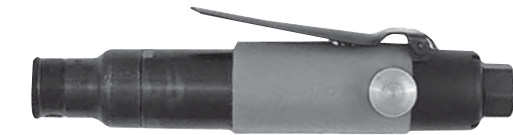

SL021B-15-Q

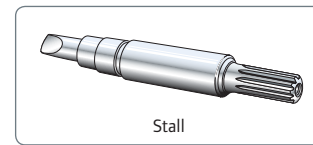

Kits:

- 20 Series tune-up kit: 46992
- 50 Series tune-up kit: 47353

Model	in-lbs (Nm)	rpm	lbs (kg)	in (mm)	in (mm)	in	cfm (L/min)
20 SERIES LEVER START							
SL021B-26-Q	12 (1.5)	2,600	0.9 (0.4)	6.2" (157)	0.6" (15)	1/4"	15 (420)
SL021B-15-Q	25 (2.8)	1,500	1.0 (0.5)	6.5" (167)	0.6" (15)	1/4"	15 (420)
SL021B-9-Q	38 (4.3)	900	1.0 (0.5)	6.5" (167)	0.6" (15)	1/4"	15 (420)
50 SERIES LEVER START							
SL051B-25-Q	45 (4.0)	2,500	2.2 (1.0)	8.1" (206)	0.8" (21)	1/4"	25 (720)
SL051B-17-Q	65 (7.3)	1,700	2.4 (1.1)	8.9" (225)	0.8" (21)	1/4"	25 (720)
SL051B-10-Q	90 (10.2)	1,000	2.4 (1.1)	8.9" (225)	0.8" (21)	1/4"	25 (720)
SL051B-8-Q	120 (13.6)	800	2.4 (1.1)	8.9" (225)	0.8" (21)	1/4"	25 (720)

Series	76 dBA	1/4" NPT	5/16" (8mm)
20	76 dBA	1/4" NPT	5/16" (8mm)
50	78 dBA	1/4" NPT	5/16" (8mm)

Inline Air Screwdrivers

Stall

Q2 Series

Sets the standard for assembly tool ergonomics.

Features

- Torque range: 16 – 51 in-lbs (1.8 – 5.8 Nm)
- Speeds: 1,000 – 2,800 rpm
- Compact, lightweight, well-balanced design
- Egg-shaped housing employs a natural fit
- Soft-grip surface over molded on a composite core provides a comfortable texture and temperature
- Recommended for soft draw applications in wood or other materials not requiring critical torque control



QS1L10D1D

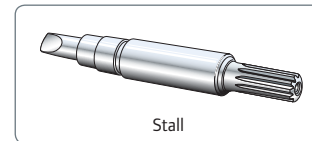

Service and Accessories

Manuals:

- 16574501
- 80165921
- 16575193

Accessories:

- Spring balancer, see page 177
- Workstation, see page 182
- Spindle accessories, see page 183
- Piped away exhaust kit: L01-K284

Kits:

- Inlet / throttle / motor tune up kit: Q2-TK1

Model	in-lbs (Nm)	rpm	lbs (kg)	in (mm)	in (mm)	in	cfm (L/min)
DC LEVER START							
QS1L28D1D	16 (1.8)	2,800	1.3 (0.6)	9.5" (241)	0.9" (22)	1/4"	16 (460)
QS1L20D1D	26 (2.9)	2,000	1.3 (0.6)	9.5" (241)	0.9" (22)	1/4"	16 (460)
QS1L10D1D	51 (5.8)	1,000	1.3 (0.6)	9.5" (241)	0.9" (22)	1/4"	16 (460)

Series			
Q2	75 dBA	1/4" NPT	1/4" (6 mm)

41 Series

Time-tested design known for its durability and performance.

Features

- Torque Range: 45 – 120 in-lbs (5.1 – 13.6 Nm)
- Speeds: 800 – 2,500 rpm
- Skinsulate housing provides a comfortable grip surface, requiring less force and pressure during operation
- Simple push-button reverse
- Recommended for soft pull applications not requiring critical torque control

Service and Accessories

Manuals:

-  80167356
-  16575284

Accessories:

- Dead handle: 48931
- Torque reaction arm: QTA010
- Spindle accessories, see page 183
- Bail: 46328





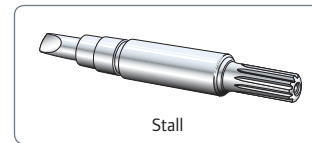





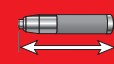

41SD10LTQ4



Kits:

- Mechanism tune-up kit: 48804-1

Model	 in-lbs (Nm)	 rpm	 lbs (kg)	 in (mm)	 in (mm)	 in	 cfm (L/min)
DC LEVER START							
41SD25LTQ4	45 (5.1)	2,500	2.1 (1.0)	8.1" (206)	0.8" (20)	1/4" 	20 (565)
41SD17LTQ4	65 (7.3)	1,700	2.3 (1.1)	8.9" (226)	0.8" (20)	1/4" 	20 (565)
41SD10LTQ4	90 (10.2)	1,000	2.3 (1.1)	8.9" (226)	0.8" (20)	1/4" 	20 (565)
41SD8LTQ4	120 (13.6)	800	2.3 (1.1)	8.9" (226)	0.8" (20)	1/4" 	20 (565)

Series			
41	75 dBA	1/4" NPT	5/16" (8 mm)



Angle Air Nutrunners

Torque Selection Guide

Adjustable Shut-Off Clutch

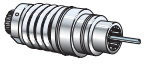

Model	0 Nm	25 Nm	50 Nm	75 Nm	100 Nm	250 Nm	Referral page
QA1L18S4LD	█						96
QA1L12S4LD	█						96
QA1L05S4SD	█						96
1RLN2S5	█						95
QA1L08S4LD	█						96
QA1L02S4LD	█						97
41AA9LTS6	█						99
41AA6LTS6	█						99
QA4AALS020NP25S06		█					100
QA4AALS030NP28S06		█					100
QA6AALS040NP35S06		█					101
QA4AALS...		█					100
QA6AALS070NP35S06			█				101
QA8AALS070NP43S08			█				102
QA6AALS...		█					101
QA8AALS090NP43S08			█				102
QA8AALS...		█					102

Adjustable Cushion Clutch



Model	0 Nm	5 Nm	10 Nm	15 Nm	20 Nm	Referral page
QA1L18C4LD		█				103
QA1L12C4LD		█				103
5RLK2C5		█				106
QA1L08C4LD		█				103
5RLL2C5		█				106
QA1L05C1LD		█				104
SR053B-11H-H		█				105
5RLN2C6		█				106
7RLL2C6		█				106
7RLM3C6		█				106
SR053B-6H-H		█				105

Stall



Model	0 Nm	25 Nm	50 Nm	75 Nm	100 Nm	250 Nm	Referral page
SR021B-17R-H	█						107
SR021B-10R-H	█						107
QA1L12D4LD	█						108
5RLK2D6	█						110
5RLL2D6	█						110
QA1L08D4LD	█						108
QA1L02D6LD	█						108
7RLL3D6	█						110
QA1L05D4LD	█						108
5RLN2D6	█						110
7RLM3D6	█						110
7RLN3D6	█						110
QA4AALD...	█						112
9RSQ83	█						110
QA6AALD...	█						113
QA8AALD...	█						114

Angle Air Nutrunners

Adjustable Shut-Off

1 Series

Time-tested design provides repeatable results day in and day out at an economical price.

Features

- Torque Range: 3.5 – 46.0 in-lbs (0.4 – 5.2 Nm)
- Speeds: 700 rpm
- Compact and lightweight
- Coated grip for operator comfort
- 1/4" quick change or square drive options
- Recommended for applications where precise torque control is required

Service and Accessories

Manuals:

- 16574568
- 80167380
- 16575250

Accessories:

Spring balancer: BLD1
Spindle accessories, see page 183

Kits:

Tune up kit: 0-TK2



1RLN2S3

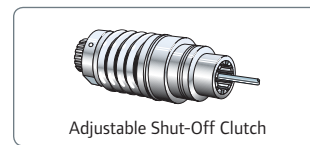

Adjustable Shut-Off Clutch

Model	in-lbs (Nm)	in-lbs (Nm)	in-lbs (Nm)	rpm	lbs (kg)	in (mm)	in (mm)	in (mm)	in
DC LEVER START									
1RLN2S5	3.5 – 23.0 (0.4 – 2.6)	7.1 – 34.5 (0.8 – 3.9)	9.7 – 46.0 (1.1 – 5.2)	700	1.7 (0.8)	12.5" (318)	0.52" (13.2)	1.3" (33)	1/4" □
1RLN2S3	3.5 – 23.0 (0.4 – 2.6)	7.1 – 34.5 (0.8 – 3.9)	9.7 – 46.0 (1.1 – 5.2)	700	1.7 (0.8)	12.5" (318)	0.52" (13.2)	1.3" (33)	1/4" ○

Series	73 dBA	1/8" NPT	1/4" (6 mm)	13 cfm (368 L/min)
1	73 dBA	1/8" NPT	1/4" (6 mm)	13 cfm (368 L/min)

Angle Air Nutrunners

Adjustable Shut-Off

Q2 Series

Sets the standard for assembly tool ergonomics.

Features

- Torque range: 3.5 – 101.5 in-lbs (0.4 – 11.5 Nm)
- Speeds: 250 – 1,750 rpm
- Offers precise torque control in a quiet, award-winning ergonomic package
- Compact, lightweight, well-balanced design
- Contoured soft grip handle
- Low force forward reverse control
- Recommended for applications where precise torque control is required



QA1L05S4LD

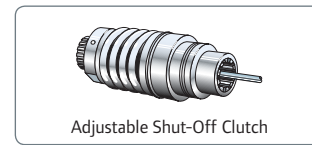

Adjustable Shut-Off Clutch

Service and Accessories

Manuals:

- 16574543
- 80167406
- 16584062

Accessories:

- Spring balancer, see page 177
- Vertical hanger: 7L-365
- Piped away exhaust kit: LG1-K284























Kits:





- Service kit: 48803-1
- Clutch kit: Q2-ASO-TK1
- Inlet / throttle / motor kit: Q2-TK1

Model	in-lbs (Nm)	in-lbs (Nm)	in-lbs (Nm)	rpm	lbs (kg)	in (mm)	in (mm)	in (mm)	in
DC LEVER START									
QA1L18S4LD	3.5 – 11.5 (0.4 – 1.3)	9.3 – 26.1 (1.05 – 2.95)	–	1,750	2.1 (1.0)	11.9" (302.3)	0.52" (13.2)	1.3" (33)	1/4" □
QA1L18S4SD	3.5 – 11.5 (0.4 – 1.3)	9.3 – 26.1 (1.05 – 2.95)	–	1,750	1.9 (0.9)	11.8" (300)	0.38" (9.5)	1.1" (28)	1/4" □
QA1L18S6LD	3.5 – 11.5 (0.4 – 1.3)	9.3 – 26.1 (1.05 – 2.95)	–	1,750	2.1 (1.0)	11.9" (302.3)	0.52" (13.2)	1.3" (33)	3/8" □
QA1L18S1LD	3.5 – 11.5 (0.4 – 1.3)	9.3 – 26.1 (1.05 – 2.95)	–	1,750	2.1 (1.0)	11.9" (302.3)	0.52" (13.2)	1.3" (33)	1/4" ⦿
QA1L18S9LD	3.5 – 11.5 (0.4 – 1.3)	9.3 – 26.1 (1.05 – 2.95)	–	1,750	2.1 (1.0)	11.9" (302.3)	0.52" (13.2)	1.3" (33)	1/4" ⦿
QA1L12S4LD	3.5 – 11.5 (0.4 – 1.3)	9.3 – 32.2 (1.1 – 3.64)	–	1,270	2.1 (1.0)	11.9" (302.3)	0.52" (13.2)	1.3" (33)	1/4" □
QA1L12S4SD	3.5 – 11.5 (0.4 – 1.3)	9.3 – 32.2 (1.1 – 3.64)	–	1,270	1.9 (0.9)	11.8" (300)	0.38" (9.5)	1.1" (28)	1/4" □
QA1L12S1LD	3.5 – 11.5 (0.4 – 1.3)	9.3 – 32.2 (1.1 – 3.64)	–	1,270	2.1 (1.0)	11.9" (302.3)	0.52" (13.2)	1.3" (33)	1/4" ⦿
QA1L12S9LD	3.5 – 11.5 (0.4 – 1.3)	9.3 – 32.2 (1.1 – 3.64)	–	1,270	2.1 (1.0)	11.9" (302.3)	0.52" (13.2)	1.3" (33)	1/4" ⦿
QA1L08S4LD	3.5 – 11.5 (0.4 – 1.3)	9.3 – 33.4 (1.05 – 3.77)	15.7 – 47.2 (1.77 – 5.33)	850	2.1 (1.0)	11.9" (302.3)	0.52" (13.2)	1.3" (33)	1/4" □
QA1L08S6LD	3.5 – 11.5 (0.4 – 1.3)	9.3 – 33.4 (1.05 – 3.77)	15.7 – 47.2 (1.77 – 5.33)	850	2.1 (1.0)	11.9" (302.3)	0.52" (13.2)	1.3" (33)	3/8" □

(continued next page)

Q2 Series (continued)

									
Model	in-lbs (Nm)	in-lbs (Nm)	in-lbs (Nm)	rpm	lbs (kg)	in (mm)	in (mm)	in (mm)	in
QA1108S9LD	3.5 – 11.5 (0.4 – 1.3)	9.3 – 33.4 (1.05 – 3.77)	15.7 – 47.2 (1.77 – 5.33)	850	2.1 (1.0)	11.9" (302.3)	0.52" (13.2)	1.3" (33)	1/4" 
QA1108S1LD	3.5 – 11.5 (0.4 – 1.3)	9.3 – 33.4 (1.05 – 3.77)	15.7 – 47.2 (1.77 – 5.33)	850	2.1 (1.0)	11.9" (302.3)	0.52" (13.2)	1.3" (33)	1/4" 
QA1105S4SD	3.5 – 11.5 (0.4 – 1.3)	9.3 – 36.0 (1.05 – 4.07)	–	500	1.9 (0.9)	11.8" (300)	0.38" (9.5)	1.1" (28)	1/4" 
QA1105S4LD	3.5 – 11.5 (0.4 – 1.3)	9.3 – 33.4 (1.05 – 3.77)	15.7 – 56.4 (1.77 – 6.37)	500	2.1 (0.9)	11.9" (302.3)	0.52" (13.2)	1.3" (33)	1/4" 
QA1105S6LD	3.5 – 11.5 (0.4 – 1.3)	9.3 – 33.4 (1.05 – 3.77)	15.7 – 56.4 (1.77 – 6.37)	500	2.1 (0.9)	11.9" (302.3)	0.52" (13.2)	1.3" (33)	3/8" 
QA1105S6XLD	11.7 – 38.2 (1.32 – 4.32)	31.0 – 88.3 (3.5 – 9.98)	–	500	2.3 (1.04)	13.0" (330)	0.52" (13.2)	1.3" (33)	3/8" 
QA1105S9LD	3.5 – 11.5 (0.4 – 1.3)	9.3 – 33.4 (1.05 – 3.77)	15.7 – 56.4 (1.77 – 6.37)	500	2.1 (1.0)	11.9" (302.3)	0.52" (13.2)	1.3" (33)	1/4" 
QA1105S1LD	3.5 – 11.5 (0.4 – 1.3)	9.3 – 33.4 (1.05 – 3.77)	15.7 – 56.4 (1.77 – 6.37)	500	2.1 (1.0)	11.9" (302.3)	0.52" (13.2)	1.3" (33)	1/4" 
QA1105S1XLD	11.7 – 38.2 (1.32 – 4.32)	31.0 – 88.3 (3.5 – 9.98)	–	500	2.3 (1.04)	13.0" (330)	0.52" (13.2)	1.3" (33)	1/4" 
QA1102S4LD	3.5 – 11.5 (0.4 – 1.3)	9.3 – 33.4 (1.05 – 3.77)	15.7 – 56.4 (1.77 – 6.37)	250	2.1 (1.0)	11.9" (302.3)	0.52" (13.2)	1.3" (33)	1/4" 
QA1102S1LD	3.5 – 11.5 (0.4 – 1.3)	9.3 – 33.4 (1.05 – 3.77)	15.7 – 56.4 (1.77 – 6.37)	250	2.1 (1.0)	11.9" (302.3)	0.52" (13.2)	1.3" (33)	1/4" 
QA1102S6LD	3.5 – 11.5 (0.4 – 1.3)	9.3 – 33.4 (1.05 – 3.77)	15.7 – 56.4 (1.77 – 6.37)	250	2.1 (1.0)	11.9" (302.3)	0.52" (13.2)	1.3" (33)	3/8" 
QA1102S6XLD	11.7 – 38.2 (1.32 – 4.32)	31.0 – 101.5 (3.50 – 11.5)	–	250	2.3 (1.04)	13.0" (330)	0.52" (13.2)	1.3" (33)	3/8" 
QA1102S1XLD	11.7 – 38.2 (1.32 – 4.32)	31.0 – 101.5 (3.50 – 11.5)	–	250	2.3 (1.04)	13.0" (330)	0.52" (13.2)	1.3" (33)	1/4" 

Series				
Q2	75 dBA	1/4" NPT	1/4" (6 mm)	16 cfm (450 L/min)

Angle Air Nutrunners

Adjustable Shut-Off

50 Series

Legendary performance with a well-deserved reputation for durability.

Features

- Torque Range: 20 – 130 in-lbs (2.2 – 14.7 Nm)
- Speeds: 600 – 2,400 rpm
- Auto-shut-off clutch provides accuracy with proven durability
- Multiple head and drive sizes available
- Recommended for applications where precise torque control is required

Service and Accessories

Manuals:

 49999389

Accessories:

Spring balancer: BLD2
Sockets, see form # IR-0506-016

Kits:







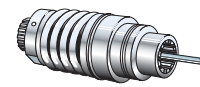













Service kit: 48804-1
Service kit: 47107







AR058A-16R-2



Adjustable Shut-Off Clutch

Model	 in-lbs (Nm)	 in-lbs (Nm)	 in-lbs (Nm)	 rpm	 lbs (kg)	 in (mm)	 in (mm)	 in (mm)	 in
DC LEVER START									
AR058A-24R-1	20 – 40 (2.2 – 4.5)	–	–	2,400	3.6 (1.6)	13.5" (343)	0.6" (15)	1.9" (48.3)	1/4" 
AR058A-24R-2	20 – 40 (2.2 – 4.5)	–	–	2,400	3.6 (1.6)	13.5" (343)	0.6" (15)	1.9" (48.3)	3/8" 
AR058A-24R-H	20 – 40 (2.2 – 4.5)	–	–	2,400	3.6 (1.6)	13.5" (343)	0.6" (15)	1.9" (48.3)	1/4" 
AR058A-16R-1	25 – 58 (2.8 – 6.5)	–	–	1,650	3.6 (1.6)	13.5" (343)	0.6" (15)	1.9" (48.3)	1/4" 
AR058A-16R-2	25 – 58 (2.8 – 6.5)	–	–	1,650	3.6 (1.6)	13.5" (343)	0.6" (15)	1.9" (48.3)	3/8" 
AR058A-16R-H	25 – 58 (2.8 – 6.5)	–	–	1,650	3.6 (1.6)	13.5" (343)	0.6" (15)	1.9" (48.3)	1/4" 
AR058A-9R-1	25 – 58 (2.8 – 6.5)	25 – 90 (2.8 – 10.2)	–	950	3.8 (1.7)	14.0" (356)	0.6" (15)	1.9" (48.3)	1/4" 
AR058A-9R-2	25 – 58 (2.8 – 6.5)	25 – 90 (2.8 – 10.2)	–	950	3.8 (1.7)	14.0" (356)	0.6" (15)	1.9" (48.3)	3/8" 
AR058A-9R-H	25 – 58 (2.8 – 6.5)	25 – 90 (2.8 – 10.2)	–	950	3.8 (1.7)	14.0" (356)	0.6" (15)	1.9" (48.3)	1/4" 
AR058A-6H-2	23 – 52 (2.6 – 5.9)	23 – 81 (2.6 – 9.2)	35 – 130 (4.0 – 14.7)	600	4.0 (1.8)	14.2" (360)	0.7" (17)	1.5" (38.1)	3/8" 
AR058A-6H-H	23 – 52 (2.6 – 5.9)	23 – 81 (2.6 – 9.2)	35 – 130 (4.0 – 14.7)	600	4.0 (1.8)	14.2" (360)	0.7" (17)	1.5" (38.1)	1/4" 
AR058A-6H-F	23 – 52 (2.6 – 5.9)	23 – 81 (2.6 – 9.2)	35 – 130 (4.0 – 14.7)	600	4.0 (1.8)	14.2" (360)	0.7" (17)	1.5" (38.1)	1/4" 

Series				
50	80 dBA	1/4" NPT	5/16" (8 mm)	25 cfm (720 L/min)

41 Series



Time-tested design known for its durability and performance.

Features

- Torque Range: 25 – 130 in-lbs (2.8 – 14.7 Nm)
- Speeds: 600 – 950 rpm
- Auto-shut-off clutch provides accuracy with proven durability
- Multiple drive sizes available
- Recommended for applications where precise torque control is required

Service and Accessories

Manuals:

-  16574600
-  80167398

Accessories:

Spring balancer: BLD2
Sockets, see form # IR-0506-016





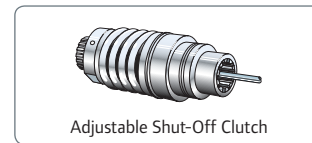





41AA9LTS6







Adjustable Shut-Off Clutch

Kits:

Service kit: 48804-1

Model	 in-lbs (Nm)	 in-lbs (Nm)	 in-lbs (Nm)	 rpm	 lbs (kg)	 in (mm)	 in (mm)	 in (mm)	 in
DC LEVER START									
41AA9LTS6	25 – 58 (2.8 – 6.5)	25 – 90 (2.8 – 10.2)	–	950	3.9 (1.8)	14.2" (360)	0.6" (15.0)	1.5" (38.1)	3/8" □
41AA9LTH4	25 – 58 (2.8 – 6.5)	25 – 90 (2.8 – 10.2)	–	950	3.9 (1.8)	14.2" (360)	0.6" (15.0)	1.5" (38.1)	1/4" ○
41AA6LTS6	23 – 52 (2.6 – 5.9)	23 – 81 (2.6 – 9.2)	35 – 130 (4.0 – 14.7)	600	4.0 (1.8)	14.2" (360)	0.7" (17.8)	1.9" (48.3)	3/8" □
41AA6LTH4	23 – 52 (2.6 – 5.9)	23 – 81 (2.6 – 9.2)	35 – 130 (4.0 – 14.7)	600	4.0 (1.8)	14.2" (360)	0.7" (17.8)	1.9" (48.3)	1/4" ○

Series				
41	79 dBA	1/4" NPT	5/16" (8 mm)	31 cfm (878 L/min)

Angle Air Nutrunners

Adjustable Shut-Off

QA4 Series

Accuracy, durability, and flexibility combine to maximize productivity.

Features

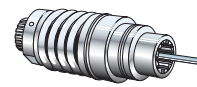

- Torque Range: 3.7 – 40.6 ft-lbs (5.0 – 55 Nm)
- Speeds: 200 – 1,025 rpm
- Adjustable shut-off clutch provides repeatability that improves joint quality
- Quick, precise shut-off limits scatter and torque reaction
- Lube-free motor
- Proven durability using world-class QE Series components
- Ergonomic grip for operator comfort
- Recommended for applications where precise torque control is required



Adjustable Shut-Off Clutch

Service and Accessories

Manuals:









-  80160344
-  80160336
-  80217474





Accessories:

- Torque arms, see page 180
- Swivel hanger: 129851
- Piped away exhaust kit: QA4-EXH-989
- Cycle count part kit: 131711
- Mounting flanges, see page 47
- Spring balancer, see page 177

Kits:

- Motor kit: QA4-1-K53
- Housing kit: QA4-1-K40
- Clutch ball kit: QA4-1-K581

									
Model	90 psi ft-lbs (Nm)	90 psi rpm	77 psi ft-lbs (Nm)	77 psi rpm	lbs (kg)	in (mm)	in (mm)	in (mm)	in
DC LEVER START									
QA4AALS011NP25S06	3.7 – 8.5 (5.0 – 11)	1,025	3.7 – 7.2 (5.0 – 9.7)	953	3.17 (1.44)	13.5" (342)	0.50" (13)	1.28" (33)	3/8" <input type="checkbox"/>
QA4AALS015NP25S06	5.2 – 11.1 (7.0 – 15)	800	5.2 – 9.4 (7.0 – 12.7)	744	3.17 (1.44)	13.5" (342)	0.50" (13)	1.28" (33)	3/8" <input type="checkbox"/>
QA4AALS020NP25S06	7.4 – 14.8 (10 – 20)	625	7.4 – 12.5 (10 – 17)	581	3.17 (1.44)	13.5" (342)	0.50" (13)	1.28" (33)	3/8" <input type="checkbox"/>
QA4AALS020NP28S06	7.4 – 14.8 (10 – 20)	625	7.4 – 12.5 (10 – 17)	581	3.35 (1.52)	14.3" (363)	0.55" (14)	1.39" (35)	3/8" <input type="checkbox"/>
QA4AALS030NP28S06	11.1 – 22.1 (15 – 30)	425	11.1 – 18.8 (15 – 25.5)	395	3.35 (1.52)	14.3" (363)	0.55" (14)	1.39" (35)	3/8" <input type="checkbox"/>
QA4AALS040NP35S06	14.8 – 29.5 (20 – 40)	325	14.8 – 25.1 (20 – 34)	302	3.98 (1.81)	15.6" (395)	0.69" (18)	1.71" (44)	3/8" <input type="checkbox"/>
QA4AALS040NP35S08	14.8 – 29.5 (20 – 40)	325	14.8 – 25.1 (20 – 34)	302	4.00 (1.81)	15.6" (395)	0.69" (18)	1.71" (44)	1/2" <input type="checkbox"/>
QA4AALS055NP35S08	18.4 – 40.6 (25 – 55)	200	18.4 – 33.6 (25 – 45.5)	186	4.50 (2.04)	16.4" (418)	0.69" (18)	1.71" (44)	1/2" <input type="checkbox"/>

Series				
QA4	79.3 dBA	1/4" NPT	3/8" (8 mm)	27 cfm (765 L/min)

QA6 Series

Accuracy, durability, and flexibility combine to maximize productivity.

Features

- Torque Range: 11.1 – 66.4 ft-lbs (15 – 90 Nm)
- Speeds: 175 – 580 rpm
- Adjustable shut-off clutch provides repeatability that improves joint quality
- Quick, precise shut-off limits scatter and torque reaction
- Lube-free motor
- Proven durability using world-class QE Series components
- Ergonomic grip for operator comfort
- Recommended for applications where precise torque control is required

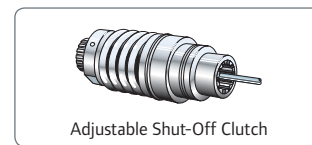

Service and Accessories

Manuals:

- 16601072
- 16601064
- 16601056

Accessories:

- Swivel hanger: QA6-A365-S
- Piped away exhaust kit: QA6-K284
- Torque arms, see page 180
- Mounting flanges, see page 47
- Sockets, see form # IR-0506-016

Kits:

- Motor kit: QA6-1-K53
- Clutch ball kit: QA6-1-K581
- Housing kit: QA6-1-K581

Model	90 psi ft-lbs (Nm)	90 psi rpm	77 psi ft-lbs (Nm)	77 psi rpm	lbs (kg)	in (mm)	in (mm)	in (mm)	in	
QC LEVER START										
QA6AALS030NP35S06	11.1 – 22.1 (15 – 30)	580	11.1 – 19.9 (15 – 27)	550	5.05 (2.29)	16.9" (429)	0.69" (18)	1.71" (44)	3/8"	
QA6AALS040NP35S06	14.8 – 29.5 (20 – 40)	430	14.8 – 25.8 (20 – 35)	405	5.05 (2.29)	16.9" (429)	0.69" (18)	1.71" (44)	3/8"	
QA6AALS040NP35S08	14.8 – 29.5 (20 – 40)	430	14.8 – 25.8 (20 – 35)	405	5.07 (2.30)	16.9" (429)	0.69" (18)	1.71" (44)	1/2"	
QA6AALS055NP35S08	18.4 – 40.6 (25 – 55)	320	18.4 – 36.1 (25 – 49)	300	5.07 (2.30)	16.9" (429)	0.69" (18)	1.71" (44)	1/2"	
QA6AALS070NP43S08	25.8 – 51.6 (35 – 70)	225	25.8 – 45.7 (35 – 62)	215	5.07 (2.30)	16.6" (422)	0.85" (22)	1.76" (45)	1/2"	
QA6AALS090NP43S08	33.2 – 66.4 (45 – 90)	185	33.2 – 59 (45 – 80)	175	5.07 (2.30)	16.6" (422)	0.85" (22)	1.76" (45)	1/2"	

Series				
QA6	82.5 dBA	3/8" NPT	1/2" (13 mm)	36 cfm (1019 L/min)

Angle Air Nutrunners

Adjustable Shut-Off

QA8 Series

Accuracy, durability, and flexibility combine to maximize productivity.

Features

- Torque Range: 14.8 – 166 ft-lbs (20 – 225 Nm)
- Speeds: 85 – 570 rpm
- Adjustable shut-off clutch provides repeatability that improves joint quality
- Quick, precise shut-off limits scatter and torque reaction
- Lube-free motor
- Proven durability using world-class QE Series components
- Ergonomic grip for operator comfort
- Recommended for applications where precise torque control is required

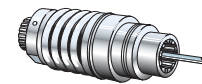

Adjustable Shut-Off Clutch

Service and Accessories

Manuals:

- 16601072
- 16601064
- 16601056

Accessories:

- Swivel hanger: QA6-A365-S
- Piped away exhaust kit: QA6-K284
- Torque arms, see page 180
- Mounting flanges, see page 47
- Sockets, see form # IR-0506-016

Kits:

- Motor kit: QA6-1-K53
- Clutch ball kit: QA6-1-K581
- Housing kit: QA8-1-K40

Model									
	90 psi ft-lbs (Nm)	90 psi rpm	77 psi ft-lbs (Nm)	77 psi rpm	lbs (kg)	in (mm)	in (mm)	in (mm)	in
QA8AALS040NP35S06	14.8 – 29.5 (20 – 40)	570	14.8 – 25.8 (20 – 35)	540	5.38 (2.44)	17.8" (453)	0.69" (18)	1.71" (44)	3/8"
QA8AALS040NP35S08	14.8 – 29.5 (20 – 40)	570	14.8 – 25.8 (20 – 35)	540	5.40 (2.45)	17.8" (453)	0.69" (18)	1.71" (44)	1/2"
QA8AALS055NP35S08	18.4 – 40.6 (25 – 55)	425	18.4 – 36.1 (25 – 49)	400	5.40 (2.45)	17.8" (453)	0.69" (18)	1.71" (44)	1/2"
QA8AALS070NP43S08	25.8 – 51.6 (35 – 70)	320	25.8 – 45.7 (35 – 62)	305	5.40 (2.45)	17.5" (445)	0.85" (22)	1.76" (45)	1/2"
QA8AALS090NP43S08	33.2 – 66.4 (45 – 90)	255	33.2 – 59.0 (45 – 80)	240	5.40 (2.45)	17.5" (445)	0.85" (22)	1.76" (45)	1/2"
QA8AALS115NP48S08	51.6 – 84.8 (70 – 115)	200	51.6 – 75.2 (70 – 102)	190	6.15 (2.79)	17.8" (452)	0.97" (25)	1.97" (50)	1/2"
QA8AALS150NP48S08	55.3 – 110.6 (75 – 150)	145	55.3 – 98.1 (75 – 133)	140	6.88 (3.12)	19.2" (489)	0.97" (25)	1.97" (50)	1/2"
QA8AALS200NF56S12	73.8 – 147.5 (100 – 200)	110	73.8 – 131.3 (100 – 178)	105	8.86 (4.02)	20" (508)	1.19" (30)	2.09" (53)	3/4"
QA8AALS225NF56S12	92.2 – 166 (125 – 225)	90	92.2 – 163.7 (125 – 222)	85	8.86 (4.02)	20" (508)	1.19" (30)	2.09" (53)	3/4"

Series				
QA8	87 dBA	3/8" NPT	1/2" (13 mm)	41 cfm (1161 L/min)

Angle Air Nutrunners

Adjustable Cushion Clutch

Q2 Series

Sets the standard for assembly tool ergonomics.

Features

- Torque range: 3.5 – 56.4 in-lbs (0.4 – 6.4 Nm)
- Speeds: 500 – 1,750 rpm
- Offers torque limiting control in a quiet, award-winning ergonomic package
- Compact, lightweight, well-balanced design
- Contoured soft grip handle
- Low force forward reverse control
- Recommended for applications requiring a torque limiting clutch



QA1L08C4LD

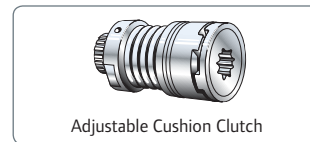

Adjustable Cushion Clutch

Service and Accessories

Manuals:

- 16574519, 16574543
- 80167406
- 16575201, 16584062

Accessories:

- Spring balancer, see page 177
- Hanger: 7L-365
- Piped away exhaust kit: LG1-K284
- Sockets, see form # IR-0506-016

Kits:

- Cushion clutch kit: Q2-CC-TK1
- Inlet / throttle / motor kit: Q2-TK1

Model	in-lbs (Nm)	in-lbs (Nm)	in-lbs (Nm)	rpm	lbs (kg)	in (mm)	in (mm)	in (mm)	in
OC LEVER START									
QA1L18C4LD	3.5 – 11.5 (0.4 – 1.3)	9.3 – 26.1 (1.05 – 2.95)	–	1,750	2.0 (0.9)	11.9" (302.3)	0.52" (13.2)	1.3" (33)	1/4"
QA1L18C1LD	3.5 – 11.5 (0.4 – 1.3)	9.3 – 26.1 (1.05 – 2.95)	–	1,750	2.0 (0.9)	11.9" (302.3)	0.52" (13.2)	1.3" (33)	1/4"
QA1L12C4LD	3.5 – 11.5 (0.4 – 1.3)	9.3 – 32.2 (1.1 – 3.64)	–	1,270	2.0 (0.9)	11.9" (302.3)	0.52" (13.2)	1.3" (33)	1/4"
QA1L12C1LD	3.5 – 11.5 (0.4 – 1.3)	9.3 – 32.7 (1.1 – 3.64)	–	1,270	2.1 (1.0)	11.9" (302.3)	0.52" (13.2)	1.3" (33)	1/4"
QA1L12C9LD	3.5 – 11.5 (0.4 – 1.3)	9.3 – 32.2 (1.1 – 3.64)	–	1,270	2.1 (1.0)	11.9" (302.3)	0.52" (13.2)	1.3" (33)	1/4"
QA1L12C6LD	3.5 – 11.5 (0.4 – 1.3)	9.3 – 32.2 (1.1 – 3.64)	–	1,270	2.1 (1.0)	11.9" (302.3)	0.52" (13.2)	1.3" (33)	3/8"
QA1L08C4LD	3.5 – 11.5 (0.4 – 1.3)	9.3 – 33.4 (1.05 – 3.77)	15.7 – 47.2 (1.77 – 5.33)	850	2.0 (0.9)	11.9" (302.3)	0.52" (13.2)	1.3" (33)	1/4"
QA1L08C1LD	3.5 – 11.5 (0.4 – 1.3)	9.3 – 33.4 (1.05 – 3.77)	15.7 – 47.2 (1.77 – 5.33)	850	2.1 (1.0)	11.9" (302.3)	0.52" (13.2)	1.3" (33)	1/4"
QA1L08C9LD	3.5 – 11.5 (0.4 – 1.3)	9.3 – 33.4 (1.05 – 3.77)	15.7 – 47.2 (1.77 – 5.33)	850	2.1 (1.0)	11.9" (302.3)	0.52" (13.2)	1.3" (33)	1/4"



(continued next page)





Series				
Q2	75 dBA	1/4" NPT	1/4" (6 mm)	16 cfm (450 L/min)

Angle Air Nutrunners

Adjustable Cushion Clutch

Q2 Series *(continued)*

Model	in-lbs (Nm)	in-lbs (Nm)	in-lbs (Nm)	rpm	lbs (kg)	in (mm)	in (mm)	in (mm)	in
DC LEVER START									
QA1L05C1LD	3.5 – 11.5 (0.4 – 1.3)	9.3 – 33.4 (1.05 – 3.77)	15.7 – 56.4 (1.77 – 6.37)	500	2.1 (1.0)	11.9" (302.3)	0.5" (12.7)	1.3" (33)	1/4" 
QA1L05C4LD	3.5 – 11.5 (0.4 – 1.3)	9.3 – 33.4 (1.05 – 3.77)	15.7 – 56.4 (1.77 – 6.37)	500	2.1 (1.0)	11.9" (302.3)	0.5" (12.7)	1.3" (33)	1/4" 
QA1L05C6LD	3.5 – 11.5 (0.4 – 1.3)	9.3 – 33.4 (1.05 – 3.77)	15.7 – 56.4 (1.77 – 6.37)	500	2.1 (1.0)	11.9" (302.3)	0.5" (12.7)	1.3" (33)	3/8" 

Series				
Q2	75 dBA	1/4" NPT	1/4" (6 mm)	16 cfm (450 L/min)

50 Series

Legendary performance with a well-deserved reputation for durability.

Features

- Torque Range: 20 – 135 in-lbs (2.2 – 15.3 Nm)
- Speeds: 500 – 1,650 rpm
- Proven durability and reliability
- Multiple head and drive sizes available
- Recommended for applications requiring a torque limiting clutch



SR053B-6H-H

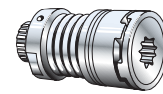

Adjustable Cushion Clutch

Service and Accessories

Manuals:

49999389

Accessories:

Spring balancer: BLD2
Sockets, see form # IR-0506-016

Kits:

Service kit: 48804-1
Service kit: 47407

Model	in-lbs (Nm)	in-lbs (Nm)	rpm	lbs (kg)	in (mm)	in (mm)	in (mm)	in
DC LEVER START								
SR053B-11H-H	20 – 70 (2.2 – 7.9)	–	1,150	4.0 (1.8)	14.2" (360)	0.7" (16.5)	1.9" (48.3)	1/4"
SR053B-11H-F	20 – 70 (2.2 – 7.9)	–	1,150	4.0 (1.8)	14.2" (360)	0.7" (16.5)	1.9" (48.3)	1/4"
SR053B-8H-H	25 – 100 (2.8 – 11.3)	–	800	4.0 (1.8)	14.2" (360)	0.7" (16.5)	1.9" (48.3)	1/4"
SR053B-6H-H	25 – 100 (2.8 – 11.3)	40 – 135 (4.5 – 15.3)	500	4.0 (1.8)	14.2" (360)	0.7" (16.5)	1.9" (48.3)	1/4"
NR053B-16R-1	25 – 58 (2.8 – 6.5)	–	1,650	3.6 (1.6)	13.5" (343)	0.6" (15.0)	1.5" (38.1)	1/4"
NR053B-11H-2	20 – 70 (2.2 – 7.9)	–	1,150	4.0 (1.8)	14.2" (360)	0.7" (16.5)	1.9" (48.3)	3/8"
NR053B-8H-2	25 – 100 (2.8 – 11.3)	–	800	4.0 (1.8)	14.2" (360)	0.7" (16.5)	1.9" (48.3)	3/8"
NR053B-6H-2	25 – 100 (2.8 – 11.3)	40 – 135 (4.5 – 15.3)	500	4.0 (1.8)	14.2" (360)	0.7" (16.5)	1.9" (48.3)	3/8"

Series				
50	80 dBA	1/4" NPT	5/16" (8 mm)	25 cfm (720 L/min)

Angle Air Nutrunners

Adjustable Cushion Clutch

5 & 7 Series



Durability and performance are the hallmarks of these proven winners.

Features

- Torque range: 10 – 130 in-lbs (1.7 – 14.8 Nm)
- Speeds: 600 – 1,800 rpm
- Convenient push-button reverse
- Proven quality and reliability
- Recommended for applications requiring a torque limiting clutch

Service and Accessories

Manuals:

-  80167471 5 Series
-  16584047 7 Series
-  16584054

Accessories:

- Spring balancer, see page 177
- Piped away exhaust kit: (5 Series) 5L-K184
(7 Series) 7L-K284
- Sockets, see form # IR-0506-016

Kits:







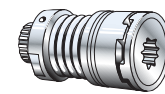









- Tune-up kit: 7RL-S/D-A/ T-TK1







5RLN2C3



Adjustable Cushion Clutch

								
Model	in-lbs (Nm)	in-lbs (Nm)	rpm	lbs (kg)	in (mm)	in (mm)	in (mm)	in
5C 5 SERIES LEVER START								
5RLK2C5	10 – 40 (1.14 – 4.55)	15 – 35 (1.71 – 3.98)	1,800	3.1 (1.4)	12.4" (315)	0.52" (13.2)	1.3" (33.0)	1/4" 
5RLK2C3	10 – 40 (1.14 – 4.55)	15 – 35 (1.71 – 3.98)	1,800	3.1 (1.4)	12.4" (315)	0.52" (13.2)	0.5" (12.7)	1/4" 
5RLL2C5	15 – 55 (1.7 – 6.3)	20 – 55 (2.28 – 6.26)	1,300	3.1 (1.4)	12.4" (315)	0.52" (13.2)	1.3" (33.0)	1/4" 
5RLN2C3	15 – 80.5 (1.7 – 9.1)	50.4 – 110.6 (5.69 – 12.51)	600	3.1 (1.4)	13.1" (330)	0.52" (13.2)	0.5" (12.7)	1/4" 
5RLN2C6	15.0 – 80.5 (1.7 – 9.1)	50.4 – 110.6 (5.7 – 12.51)	600	3.4 (1.5)	13.1" (330)	0.52" (13.2)	1.3" (33.0)	3/8" 
5C 7 SERIES LEVER START								
7RLL2C6	25 – 80 (2.84 – 9.10)	25 – 100 (2.84 – 12.51)	1,400	3.3 (1.5)	13.2" (335)	0.52" (13.2)	1.3" (33.0)	3/8" 
7RLL3C6	25 – 80 (2.84 – 9.10)	25 – 110 (2.84 – 12.51)	1,400	4.8 (2.2)	14.3" (363)	0.54" (13.7)	1.5" (38.1)	3/8" 
7RLM3C6	25 – 90 (2.84 – 10.24)	25 – 130 (2.84 – 14.79)	800	5.0 (2.3)	14.3" (363)	0.54" (13.7)	1.5" (38.1)	3/8" 

Series				
5	75 dBA	1/4" NPT	1/4" (6 mm)	16 cfm (450 L/min)
7	79 dBA	1/4" NPT	5/16" (6 mm)	27 cfm (760 L/min)

Angle Air Nutrunners

Stall

20 Series

Legendary performance in a compact, lightweight package.

Features

- Torque Range: 17 – 27 in-lbs (1.9 – 3.0 Nm)
- Speeds: 1,000 – 1,750 rpm
- Compact, lightweight design
- Multiple drive sizes available
- Torque control through pressure regulation or operator control
- Recommended for soft pull applications not requiring critical torque control

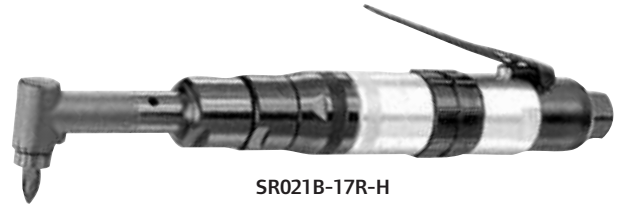

SR021B-17R-H

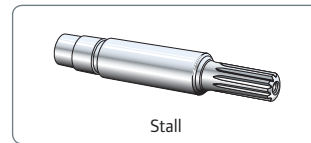

Stall

Service and Accessories

Manuals:

49999043

Accessories:

Spring balancer: BLD1
Spindle accessories, see page 183

Kits:

Service kit: 48803-1

Model	in-lbs (Nm)	rpm	lbs (kg)	in (mm)	in (mm)	in (mm)	in
LEVER START							
SR021B-17R-H	17 (1.9)	1750	1.7 (0.8)	9.5" (241)	0.6" (15.0)	1.5" (38.1)	1/4"
SR021B-10R-H	27 (3.0)	1,000	1.8 (0.8)	9.9" (252)	0.6" (15.0)	1.5" (38.1)	1/4"
LEVER START WITH PUSH BUTTON REVERSE							
SRB21A-17-H	17 (1.9)	1,750	1.7 (0.8)	9.5" (241)	0.52" (13.2)	1.5" (38.1)	1/4"
SRB21A-17-P	17 (1.9)	1,750	1.7 (0.8)	9.5" (241)	0.52" (13.2)	1.8" (45.7)	1/4"

Series				
20	76 dBA	1/4" NPT	5/16" (8 mm)	15 cfm (420 L/min)

Angle Air Nutrunners

Stall

Q2 Series



Award-winning design delivers the performance you need.

Features

- Torque Range: 35.4 – 102.3 in-lbs (4 – 11.6 Nm)
- Speeds: 250 – 1,270 rpm
- Compact, lightweight, well-balanced design
- Contoured soft grip handle
- Low force forward reverse controls
- Torque control through pressure regulation or operator control
- Recommended for soft pull applications not requiring critical torque control

Service and Accessories

Manuals:

-  16574519
-  80167406
-  16575201, 16584062

Accessories:

Spring balancer, see page 177
Sockets, see form # IR-0506-016
Piped away exhaust: LG1-K284
Vertical hanger: 7L-365

Kits:







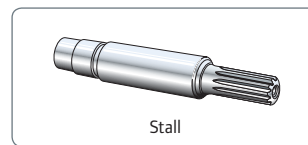









Inlet / Throttle / Motor kits: Q2-TK1







QA1L05D6LD



Stall

							
Model	in-lbs (Nm)	rpm	lbs (kg)	in (mm)	in (mm)	in (mm)	in
DC LEVER START							
QA1L12D4LD	35.4 (4.0)	1,270	1.5 (0.7)	8.9" (226)	0.52" (13.2)	1.3" (33)	1/4" 
QA1L12D6LD	35.4 (4.0)	1,270	1.5 (0.7)	8.9" (226)	0.52" (13.2)	1.3" (33)	3/8" 
QA1L12D1LD	35.4 (4.0)	1,270	1.5 (0.7)	8.9" (226)	0.52" (13.2)	1.3" (33)	1/4" 
QA1L08D4LD	60.2 (6.8)	850	1.5 (0.7)	8.9" (226)	0.52" (13.2)	1.3" (33)	1/4" 
QA1L08D6LD	60.2 (6.8)	850	1.5 (0.7)	8.9" (226)	0.52" (13.2)	1.3" (33)	3/8" 
QA1L08D1LD	60.2 (6.8)	850	1.5 (0.7)	8.9" (226)	0.52" (13.2)	1.3" (33)	1/4" 
QA1L05D4LD	102.3 (11.6)	500	1.5 (0.7)	8.9" (226)	0.52" (13.2)	1.3" (33)	1/4" 
QA1L05D6LD	102.3 (11.6)	500	1.5 (0.7)	8.9" (226)	0.52" (13.2)	1.3" (33)	3/8" 
QA1L05D1LD	102.3 (11.6)	500	1.5 (0.7)	8.9" (226)	0.54" (13.7)	1.3" (33)	1/4" 
QA1L02D6LD	85.3 (9.7)	250	1.5 (0.7)	8.9" (226)	0.54" (13.7)	1.3" (33)	3/8" 

Series				
Q2	75 dBA	1/4" NPT	1/4" (6 mm)	16 cfm (450 L/min)

50 Series

Legendary performance with a well-deserved reputation for durability.

Features

- Torque Range: 41 – 150 in-lbs (4.6 – 17 Nm)
- Speeds: 600 – 2,400 rpm
- Proven durability and reliability
- Multiple head and drive sizes available
- Torque control through pressure regulation or operator control
- Recommended for soft pull applications not requiring critical torque control



NR051B-16R-2

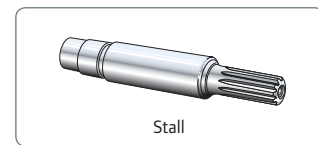

Service and Accessories

Manuals:

49999389, 49999456

Accessories:

Spring balancer: BLD2
Spindle accessories, see page 183

Kits:

Service kit: 47407
Service kit: 48804-1

Model	in-lbs (Nm)	rpm	lbs (kg)	in (mm)	in (mm)	in (mm)	in
DC LEVER START							
SR051B-24R-H	41 (4.6)	2,400	2.6 (1.2)	10.7" (272)	0.53" (13.5)	1.5" (38.1)	1/4"
SR051B-16R-H	62 (7.0)	1,600	2.6 (1.2)	10.7" (272)	0.53" (13.5)	1.5" (38.1)	1/4"
SR051B-16R-F	62 (7.0)	1,600	2.6 (1.2)	10.7" (272)	0.53" (13.5)	1.5" (38.1)	1/4"
SR051B-11H-H	80 (9.0)	1,150	3.0 (1.4)	11.3" (287)	0.7" (16.5)	1.9" (48.3)	1/4"
SR051B-8H-H	120 (13.5)	800	3.0 (1.4)	11.3" (287)	0.7" (16.5)	1.9" (48.3)	1/4"
SR051B-6H-H	150 (17.0)	600	3.0 (1.4)	11.3" (287)	0.7" (16.5)	1.9" (48.3)	1/4"
NR051B-24R-2	41 (4.6)	2,400	2.7 (1.2)	10.7" (272)	0.6" (15.0)	1.5" (38.1)	3/8"
NR051B-16R-2	62 (7.0)	1,600	2.7 (1.2)	10.7" (272)	0.6" (15.0)	1.5" (38.1)	3/8"
NR051B-11H-2	80 (9.0)	1,150	4.0 (1.8)	14.2" (360)	0.7" (16.5)	1.9" (48.3)	3/8"
NR051B-8H-2	120 (13.5)	800	4.0 (1.8)	14.2" (360)	0.7" (16.5)	1.9" (48.3)	3/8"
NR051B-6H-2	150 (17)	600	4.0 (1.8)	14.2" (360)	0.7" (16.5)	1.9" (48.3)	3/8"
DC LEVER START WITH PUSH BUTTON REVERSE							
SRB51A-16-H	62 (7)	1,600	2.8 (1.3)	10.8" (274)	0.52" (13.2)	1.5" (38.1)	1/4"
SRB51A-16-P	62 (7)	1,600	2.8 (1.3)	10.8" (274)	0.52" (13.2)	1.8" (45.7)	1/4"

Series				
50	80 dBA	1/4" NPT	5/16" (8 mm)	25 cfm (720 L/min)

Angle Air Nutrunners

Stall

5, 7 & 9 Series





Durability and performance are the hallmarks of these proven winners.

Features

- Torque Range: 40 in-lbs – 82 ft-lbs (4.6 – 111.5 Nm)
- Speeds: 300 – 1,800 rpm
- Convenient push-button reverse
- Proven quality and reliability
- Torque control through pressure regulation or operator control
- Recommended for soft pull applications not requiring critical torque control

Service and Accessories

Manuals:

	P6586	5 Series
	80167471	
	P6588	7 Series
	16574089	9 Series
	80167521	

Accessories:

Reaction bar: 9SL-48 (9 Series)
Hanger: 6WS-366
Spring balancer, see page 177

Kits:





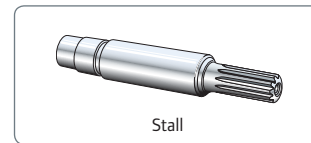

Tune-up kit: 7RL-S/D-A/T-TK1 (7 Series)







9RSQ83



Stall

							
Model	in-lbs (Nm)	rpm	lbs (kg)	in (mm)	in (mm)	in (mm)	in
5 SERIES LEVER START							
5RLK2D6	40.0 (4.6)	1,800	2.7 (1.2)	10.1" (257.3)	0.5" (13)	1.3" (33.0)	3/8" <input type="checkbox"/>
5RLL2D6	55.0 (6.3)	1,300	2.7 (1.2)	10.1" (257.3)	0.5" (13)	1.3" (33.0)	3/8" <input type="checkbox"/>
5RLN2D6	110.6 (12.5)	600	3.1 (1.4)	10.9" (276)	0.5" (13)	1.3" (33.0)	3/8" <input type="checkbox"/>
7 SERIES LEVER START							
7RLL3D6	100.0 (11.3)	1,400	3.3 (1.5)	11.0" (279)	0.7" (17.8)	1.5" (38.1)	3/8" <input type="checkbox"/>
7RLM3D6	175.0 (19.8)	800	3.5 (1.6)	11.6" (295)	0.7" (17.8)	1.5" (38.1)	3/8" <input type="checkbox"/>
7RLN3D6	265.0 (29.9)	500	3.5 (1.6)	11.6" (295)	0.7" (17.8)	1.5" (38.1)	3/8" <input type="checkbox"/>
9 SERIES LEVER START							
9RSQ83	82.0 (111.5)	300	7.6 (3.5)	17.9" (454.2)	1.0" (24.6)	1.8" (45.7)	1/2" <input type="checkbox"/>

Series				
5	75 dBA	1/4" NPT	1/4" (6 mm)	17 cfm (480 L/min)
7	79 dBA	1/4" NPT	5/16" (8 mm)	27 cfm (760 L/min)
9	82 dBA	1/2" NPT	1/2" (13 mm)	65 cfm (1841 L/min)

Flat Angle Series

Designed for limited-access, light assembly applications.

Features

- Torque Range: 54 – 90 in-lbs (6.1 – 10.2 Nm)
- Speeds: 850 – 1,450 rpm
- Flat-angle provides needed clearance
- Angle rotates 360 degrees for ease of operation
- Torque control through pressure regulation or operator control
- Recommended for soft pull applications not requiring critical torque control

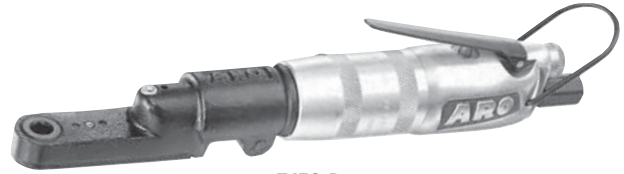

7456-D

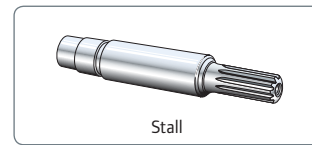

Service and Accessories

Manuals:

49999130

Accessories:

Spring balancer: BLD2
 Piped-away exhaust: 44360-10
 Socket spindles, see chart below

Model	in-lbs (Nm)	rpm	lbs (kg)	in (mm)	in (mm)	in (mm)	in
C LEVER START							
7456-D	54 (6.1)	1,450	2.9 (1.3)	11.0" (279)	0.5" (12.7)	0.7" (17.8)	3/8" Female ⁽¹⁾
7453-D	90 (10.2)	850	3.4 (1.5)	12.3" (312)	0.5" (12.7)	0.7" (17.8)	3/8" Female ⁽¹⁾

⁽¹⁾ Standard.

Series				
Flat Angle	87 dBA	1/4" NPT	5/16" (8 mm)	23 cfm (660 L/min)

Spindle Part Number	Hex Size in	Spindle Part Number	Hex Size in	Spindle Part Number	Hex Size in
HEX (FEMALE) SOCKET SPINDLES					
33532-1	1/4"	33532-5 ⁽¹⁾	3/8"	33532-9	1/2"
33532-2	9/32"	33532-6	13/32"	33532-10	17/32"
33532-3	5/16"	33532-7	7/16"	33532-11	9/16"
33532-4	11/32"	33532-8	15/32"	-	-

⁽¹⁾ Standard.

Angle Air Nutrunners

Stall

QA4 Series

Delivers dramatic improvements in speed, size, and durability.

Features

- Torque Range: up to 40 ft-lbs (55 Nm)
- Speeds: 200 – 1,025 rpm
- Proven durability using world-class QE Series components
- Economical alternative to shut-off tools
- Lube-free motor
- Torque control through pressure regulation or operator control
- Recommended for soft pull applications not requiring critical torque control

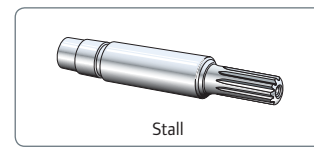

Service and Accessories

Manuals:

- 80160344
- 80160336
- 80217474

Accessories:

- Mounting flanges, see page 47
- Locking lever: 131655
- Long lever: 131654
- Swivel hanger: 129851
- Piped away exhaust kit: QA4-EXH-989
- Torque arms, see page 180
- Sockets, see form # IR-0506-016

Kits:

- Motor kit: QA4-1-K53
- Housing kit: QA4-1-K40

Model	90 psi ft-lbs (Nm)*	90 psi ft-lbs (Nm)	77 psi ft-lbs (Nm)	90 psi rpm	lbs (kg)	in (mm)	in (mm)	in (mm)	in
DC LEVER START									
QA4AALD011NP25S06	8 (11)	9.6 (10)	7 (10)	1,025	2.47 (1.12)	11.1" (342)	1.28" (33)	0.50" (13)	3/8"
QA4AALD015NP25S06	11 (15)	11.8 (20)	9 (13)	800	2.47 (1.12)	11.1" (342)	1.28" (33)	0.50" (13)	3/8"
QA4AALD020NP25S06	15 (20)	15.5 (20)	13 (17)	625	2.47 (1.12)	11.1" (342)	1.28" (33)	0.50" (13)	3/8"
QA4AALD030NP28S06	22 (30)	22.9 (30)	19 (26)	425	2.63 (1.20)	11.1" (363)	1.39" (35)	0.55" (14)	3/8"
QA4AALD040NP35S06	30 (40)	30.2 (40)	25 (34)	325	3.25 (1.48)	13.2" (363)	1.71" (44)	0.69" (18)	3/8"
QA4AALD055NP35S08	40 (55)	42.8 (60)	34 (46)	200	3.88 (1.76)	14.1" (395)	1.71" (44)	0.69" (18)	1/2"

*Note: Highest recommended torque for assembly line applications. Exceeding the highest recommended torque repeatedly may result in reduced tool life.

Series				
QA4	79.3 dBA	1/4" NPT	3/8" (10 mm)	27 cfm (765 L/min)

QA6 Series

Delivers dramatic improvements in speed, size, and durability.

Features

- Torque Range: up to 66 ft-lbs (90 Nm)
- Speeds: 185 – 580 rpm
- Proven durability using world-class QE Series components
- Economical alternative to shut-off tools
- Lube-free motor
- Torque control through pressure regulation or operator control
- Recommended for soft pull applications not requiring critical torque control

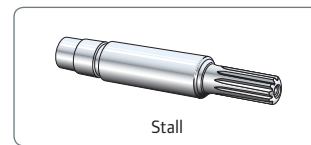

Service and Accessories

Manuals:

- 16601072
- 16601064
- 16601056

Accessories:

- Swivel hanger: QA6-A365-S
- Sockets, see form # IR-0506-016
- Angle head boots, see page 186
- Mounting flanges, see page 47
- Spanner wrench: GEA40-478
- Piped away exhaust kit: QA6-K284
- Torque arms, see page 180

Kits:

- Motor kit: QA6-1-K53
- Housing kit: QA6-1-K40

Model	90 psi ft-lbs (Nm)	90 psi ft-lbs (Nm)	77 psi ft-lbs (Nm)	90 psi rpm	lbs (kg)	in (mm)	in (mm)	in (mm)	in
DC LEVER START									
QA6AALD030NP35S06	22 (30)	28.8 (39)	20 (27)	580	4.65 (2.11)	16.9" (429)	1.71" (44)	0.69" (18)	3/8"
QA6AALD040NP35S06	30 (40)	36.1 (49)	26 (35)	430	4.65 (2.11)	16.9" (429)	1.71" (44)	0.69" (18)	3/8"
QA6AALD040NP35S08	30 (40)	36.1 (49)	26 (35)	430	4.67 (2.12)	16.9" (429)	1.71" (44)	0.69" (18)	1/2"
QA6AALD055NP35S08	41 (55)	47.9 (65)	36 (49)	320	4.67 (2.12)	16.9" (429)	1.71" (44)	0.69" (18)	1/2"
QA6AALD070NP43S08	52 (70)	64.9 (88)	46 (62)	225	4.67 (2.12)	16.6" (422)	1.76" (45)	0.85" (22)	1/2"
QA6AALD090NP43S08	66 (90)	76 (103)	59 (80)	185	4.67 (2.12)	16.6" (422)	1.76" (45)	0.85" (22)	1/2"

Series				
QA6	82.5 dBA	3/8" NPT	1/2" (13 mm)	36 cfm (1019 L/min)

Angle Air Nutrunners

Stall

QA8 Series

Delivers dramatic improvements in speed, size, and durability.

Features

- Torque Range: up to 166 ft-lbs (225 Nm)
- Speeds: 90 – 570 rpm
- Proven durability using world-class QE Series components
- Economical alternative to shut-off tools
- Lube-free motor
- Torque control through pressure regulation or operator control
- Recommended for soft pull applications not requiring critical torque control

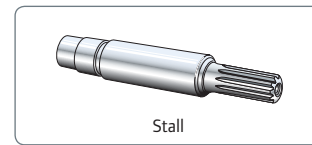

Service and Accessories

Manuals:

- 16601072
- 16601064
- 16601056

Accessories:

- Torque arms, see page 180
- Swivel hanger: QA6-A365-S
- Piped away exhaust kit: QA6-K284
- Mounting flanges, see page 47
- Sockets, see form # IR-0506-016

Kits:

- Housing kit: QA8-1-K40
- Motor kit: QA6-1-K53

Model	90 psi ft-lbs (Nm)*	90 psi ft-lbs (Nm)	77 psi ft-lbs (Nm)	90 psi rpm	lbs (kg)	in (mm)	in (mm)	in (mm)	in
DC LEVER START									
QA8AALD040NP35S06	30 (40)	38.3 (52)	26 (35)	570	4.98 (2.26)	17.8" (453)	1.71" (44)	0.69" (18)	3/8"
QA8AALD040NP35S08	30 (40)	38.3 (52)	26 (35)	570	5.00 (2.27)	17.8" (453)	1.71" (44)	0.69" (18)	1/2"
QA8AALD055NP35S08	41 (55)	50.1 (68)	36 (49)	425	5.00 (2.27)	17.8" (453)	1.71" (44)	0.69" (18)	1/2"
QA8AALD070NP43S08	52 (70)	63.4 (86)	46 (62)	320	5.00 (2.27)	17.5" (445)	1.76" (45)	0.85" (22)	1/2"
QA8AALD090NP43S08	66 (90)	79.6 (108)	59 (80)	255	5.00 (2.27)	17.5" (445)	1.76" (45)	0.85" (22)	1/2"
QA8AALD115NP48S08	85 (115)	91.4 (124)	75 (102)	200	5.75 (2.61)	17.8" (452)	1.97" (50.0)	0.97" (25)	1/2"
QA8AALD150NP48S08	111 (150)	121.7 (165)	98 (133)	145	6.48 (2.94)	19.2" (489)	1.97" (50.0)	0.97" (25)	1/2"
QA8AALD200NF56S12	148 (200)	157.1 (213)	131 (178)	110	8.47 (3.84)	20.0" (508)	2.09" (53.2)	1.19" (30)	3/4"
QA8AALD225NF56S12	166 (225)	202.1 (274)	164 (222)	90	8.47 (3.84)	20.0" (508)	2.09" (53.2)	1.19" (30)	3/4"

*Note: Highest recommended torque for assembly line applications. Exceeding the highest recommended torque repeatedly may result in reduced tool life.

Series				
QA8	87 dBA	3/8" NPT	1/2" (13 mm)	46 cfm (1303 L/min)



Inline Air Nutrunners

Torque Selection Guide

Adjustable Shut-Off

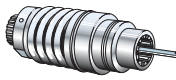

Model	0 Nm	40 Nm	80 Nm	120 Nm	160 Nm	200 Nm	Referral page
QA4ASLS012NP41S06	█						116
QA4ASLS015NP41S06	█						116
QA4ASLS020NP41S06	█	█					116
QA4ASLS027NP41S06	█	█					116
QA4ASLS046NP41S06	█	█	█				116
QA6ASLS025NP41S06	█	█	█				117
QA6ASLS030NP41S06	█	█	█				117
QA6ASLS040NP41S06	█	█	█				117
QA6ASLS055NP41S08	█	█	█	█			117
QA8ASLS040NP41S08	█	█	█	█			118
QA8ASLS055NP41S08	█	█	█	█			118
QA8ASLS070NP41S08	█	█	█	█	█		118
QA8ASLS090NP41S08	█	█	█	█	█		118
QA8ASLS115NP41S08	█	█	█	█	█		118
QA8ASLS150NP41S08	█	█	█	█	█	█	118
QA8ASLS180NP41S08	█	█	█	█	█	█	118

Remote Start Shut-Off

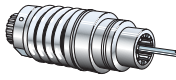

Model	0 Nm	40 Nm	80 Nm	120 Nm	160 Nm	200 Nm	Referral page
QA4ASR012NF41S06	█						119
QA4ASR015NF41S06	█						119
QA4ASR020NF41S06	█	█					119
QA4ASR027NF41S06	█	█					119
QA4ASR046NF41S06	█	█	█				119
QA6ASR025NF41S06	█	█	█				120
QA6ASR030NF41S06	█	█	█				120
QA6ASR040NF41S06	█	█	█				120
QA6ASR055NF41S06	█	█	█	█			120
QA8ASR040NF41S06	█	█	█	█			121
QA8ASR055NF41S08	█	█	█	█			121
QA8ASR070NF41S08	█	█	█	█	█		121
QA8ASR090NF41S08	█	█	█	█	█		121
QA8ASR115NF41S08	█	█	█	█	█		121
QA8ASR150NF41S08	█	█	█	█	█	█	121
QA8ASR180NF41S08	█	█	█	█	█	█	121

Remote Start Stall



Model	0 Nm	40 Nm	80 Nm	120 Nm	160 Nm	200 Nm	Referral page
QA4ASRD012NF41S06	█						122
QA4ASRD015NF41S06	█						122
QA4ASRD020NF41S06	█	█					122
QA4ASRD027NF41S06	█	█					122
QA4ASRD046NF41S06	█	█	█				122
QA6ASRD025NF41S06	█	█	█				123
QA6ASRD030NF41S06	█	█	█				123
QA6ASRD040NF41S06	█	█	█				123
QA6ASRD055NF41S08	█	█	█	█			123
QA8ASRD040NF41S06	█	█	█	█			124
QA8ASRD055NF41S08	█	█	█	█			124
QA8ASRD070NF41S08	█	█	█	█	█		124
QA8ASRD090NF41S08	█	█	█	█	█		124
QA8ASRD115NF41S08	█	█	█	█	█		124
QA8ASRD150NF41S08	█	█	█	█	█	█	124
QA8ASRD180NF41S08	█	█	█	█	█	█	124

Inline Air Nutrunners

Adjustable Shut-Off

QA4 Series

Accuracy, durability, and flexibility combine to maximize productivity.

Features

- Torque range: 4.4 – 34 ft-lbs (6.0 – 46 Nm)
- Speeds: 250 – 1,050 rpm
- Adjustable shut-off clutch provides repeatability that improves joint quality
- Quick, precise shut-off limits scatter and torque reaction
- Lube-free motor
- Proven durability using world-class QE Series components
- Ergonomic grip for operator comfort
- Recommended for applications where precise torque control is required

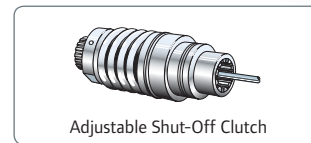

Adjustable Shut-Off Clutch

Service and Accessories

Manuals:

- 80160344
- 80160336
- 80217474

Accessories:

- Sockets, see form # IR-0506-016
- Piped away exhaust kit: QA4-EXH-989
- Cycle count port kit: 131711
- Mounting flanges, see page 47
- Torque arms, see page 180

Kits:

- Motor kit: QA4-1-K53
- Housing kit: QA4-1-K40
- Clutch ball kit: QA4-1-K581

Model	90 psi ft-lbs (Nm)	90 psi rpm	77 psi ft-lbs (Nm)	77 psi rpm	lbs (kg)	in (mm)	in (mm)	in
DC LEVER START								
QA4ASLS012NP41S06	4.4 – 8.8 (6 – 12)	1,050	4.4 – 7.4 (6 – 10)	977	3.22 (1.46)	18.3" (464)	0.81" (21)	3/8" □
QA4ASLS015NP41S06	5.2 – 11.1 (7 – 15)	850	5.2 – 9.4 (7 – 12.7)	791	3.22 (1.46)	18.3" (464)	0.81" (21)	3/8" □
QA4ASLS020NP41S06	7.4 – 14.8 (10 – 20)	600	7.4 – 12.5 (10 – 17)	558	3.22 (1.46)	18.3" (464)	0.81" (21)	3/8" □
QA4ASLS027NP41S06	10.3 – 19.9 (14 – 27)	450	10.3 – 16.7 (14 – 22.7)	419	3.22 (1.46)	18.3" (464)	0.81" (21)	3/8" □
QA4ASLS046NP41S06	14.8 – 33.9 (20 – 46)	250	14.8 – 28.0 (20 – 38)	233	3.73 (1.69)	18.8" (478)	0.91" (23)	3/8" □
QA4ASLS046NP41S08	14.8 – 33.9 (20 – 46)	250	14.8 – 28.0 (20 – 38)	233	3.77 (1.71)	18.8" (478)	0.91" (23)	1/2" □

Series				
QA4	79.3 dBA	1/4" NPT	3/8" (10 mm)	29 cfm (821 L/min)

QA6 Series

Accuracy, durability, and flexibility combine to maximize productivity.

Features

- Torque range: 8.9 – 40.6 ft-lbs (12 – 55 Nm)
- Speeds: 325 – 720 rpm
- Adjustable shut-off clutch provides repeatability that improves joint quality
- Quick, precise shut-off limits scatter and torque reaction
- Lube-free motor
- Proven durability using world-class QE Series components
- Ergonomic grip for operator comfort
- Recommended for applications where precise torque control is required

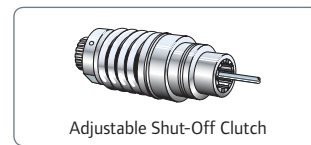

Adjustable Shut-Off Clutch

Service and Accessories

Manuals:

- 16601072
- 16601064
- 16601056

Accessories:

- Sockets, see form # IR-0506-016
- Piped away exhaust kit: QA6-K284
- Mounting flanges, see page 47
- Torque arms, see page 180

Kits:

- Housing kit: QA6-1-K40
- Clutch ball kit: QA6-1-K581
- Motor kit: QA6-1-K53

Model	90 psi ft-lbs (Nm)	90 psi rpm	77 psi ft-lbs (Nm)	77 psi rpm	lbs (kg)	in (mm)	in (mm)	in
DC LEVER START								
QA6ASLS025NP41S06	8.9 – 18.4 (12 – 25)	720	8.9 – 16.2 (12 – 22)	685	5.07 (2.30)	18.8" (478)	0.80" (20)	3/8" □
QA6ASLS030NP41S06	11.1 – 22.1 (15 – 30)	605	11.1 – 19.2 (15 – 26)	575	5.07 (2.30)	18.8" (478)	0.80" (20)	3/8" □
QA6ASLS040NP41S06	14.8 – 29.5 (20 – 40)	450	14.8 – 25.8 (20 – 35)	425	5.07 (2.30)	18.8" (478)	0.80" (20)	3/8" □
QA6ASLS055NP41S08	18.4 – 40.6 (25 – 55)	325	18.4 – 36.1 (25 – 49)	310	5.09 (2.31)	18.8" (478)	0.80" (20)	1/2" □

Series				
QA6	82.5 dBA	3/8" NPT	1/2" (13 mm)	36 cfm (1020 L/min)

Inline Air Nutrunners

Adjustable Shut-Off

QA8 Series

Accuracy, durability, and flexibility combine to maximize productivity.

Features

- Torque range: 14.8 – 132.8 ft-lbs (20 – 180 Nm)
- Speeds: 140 – 600 rpm
- Adjustable shut-off clutch provides repeatability that improves joint quality
- Quick, precise shut-off limits scatter and torque reaction
- Lube-free motor
- Proven durability using world-class QE Series components
- Ergonomic grip for operator comfort
- Recommended for applications where precise torque control is required

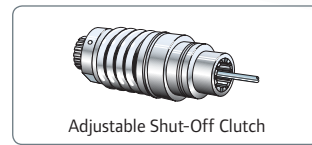

Adjustable Shut-Off Clutch

Service and Accessories

Manuals:

- 16601072
- 16601064
- 16601056

Accessories:

- Torque arm, see page 180
- Sockets, see form # IR-0506-016
- Piped away exhaust kit: QA6-K284
- Mounting flanges, see page 47

Kits:

- Housing kit: QA8-1-K40
- Motor kit: QA6-1-K53
- Clutch ball kit: QA6-1-K581

Model	90 psi ft-lbs (Nm)	90 psi rpm	77 psi ft-lbs (Nm)	77 psi rpm	lbs (kg)	in (mm)	in (mm)	in
DC LEVER START								
QA8ASLS040NP41S06	14.8 – 29.5 (20 – 40)	600	14.8 – 25.8 (20 – 35)	570	5.27 (2.39)	19.7" (502)	0.80" (20)	3/8" □
QA8ASLS040NP41S08	14.8 – 29.5 (20 – 40)	600	14.8 – 25.8 (20 – 35)	570	5.29 (2.40)	19.7" (502)	0.80" (20)	1/2" □
QA8ASLS055NP41S08	18.4 – 40.6 (25 – 55)	470	18.4 – 36.1 (25 – 49)	445	5.29 (2.40)	19.7" (502)	0.80" (20)	1/2" □
QA8ASLS070NP41S08	25.8 – 51.6 (35 – 70)	355	25.8 – 45.7 (35 – 62)	335	5.60 (2.54)	19.9" (506)	0.94" (24)	1/2" □
QA8ASLS090NP41S08	33.2 – 66.4 (45 – 90)	255	33.2 – 59.0 (45 – 80)	245	6.33 (2.87)	21.3" (542)	0.94" (24)	1/2" □
QA8ASLS115NF41S08	51.6 – 84.8 (70 – 115)	215	51.6 – 75.2 (70 – 102)	205	7.50 (3.40)	21.3" (541)	2.00" (51)	1/2" □
QA8ASLS150NF41S08	55.3 – 110.6 (75 – 150)	165	55.3 – 98.1 (75 – 133)	160	7.50 (3.40)	21.3" (541)	2.00" (51)	1/2" □
QA8ASLS180NF41S08	66.4 – 132.8 (90 – 180)	140	66.4 – 118.0 (90 – 160)	135	7.50 (3.40)	21.3" (541)	2.00" (51)	1/2" □

Series				
QA8	87 dBA	3/8" NPT	1/2" (13 mm)	46 cfm (1303 L/min)

Inline Air Nutrunners

Remote Start Shut-Off

QA4 Series

Accuracy, durability, and flexibility combine to maximize productivity.

Features

- Torque range: 4.4 – 33.9 ft-lbs (6.0 – 46 Nm)
- Speeds: 250 – 1,050 rpm
- Slim, compact design for space-saving fixturing
- Quick, precise shut-off limits scatter and torque reaction
- Integral cycle count port
- Lube-free motor
- Proven durability using world-class QE Series components
- Recommended for applications where precise torque control is required

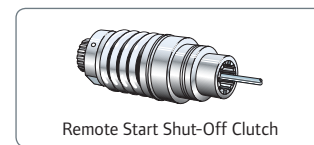

Service and Accessories

Manuals:

- 80160344
- 80160336
- 80217474

Accessories:

- Piped away exhaust kit: QA4-EXH-989
- Sockets, see form # IR-0506-016
- Mounting flanges, see page 47

Kits:

- Housing kit: QA4-1-K40
- Motor kit: QA4-1-K53
- Clutch ball kit: QA4-1-K581

Model	90 psi ft-lbs (Nm)	90 psi rpm	77 psi ft-lbs (Nm)	77 psi rpm	lbs (kg)	in (mm)	in (mm)	in
DC REMOTE START								
QA4ASRS012NF41S06	4.4 – 8.8 (6 – 12)	1,050	4.4 – 7.4 (6 – 10)	977	3.55 (1.61)	17.8" (451)	0.81" (21)	3/8" <input type="checkbox"/>
QA4ASRS015NF41S06	5.2 – 11.1 (7 – 15)	850	5.2 – 9.4 (7 – 12.7)	791	3.55 (1.61)	17.8" (451)	0.81" (21)	3/8" <input type="checkbox"/>
QA4ASRS020NF41S06	7.4 – 14.8 (10 – 20)	600	7.4 – 12.5 (10 – 17)	558	3.55 (1.61)	17.8" (451)	0.81" (21)	3/8" <input type="checkbox"/>
QA4ASRS027NF41S06	10.3 – 19.9 (14 – 27)	450	10.3 – 16.7 (14 – 22.7)	419	3.55 (1.61)	17.8" (451)	0.81" (21)	3/8" <input type="checkbox"/>
QA4ASRS046NF41S06	14.8 – 33.9 (20 – 46)	250	14.8 – 28.0 (20 – 38)	233	4.06 (1.84)	18.3" (465)	0.91" (23)	3/8" <input type="checkbox"/>
QA4ASRS046NF41S08	14.8 – 33.9 (20 – 46)	250	14.8 – 28.0 (20 – 38)	233	4.06 (1.84)	18.3" (465)	0.91" (23)	1/2" <input type="checkbox"/>

Series					
QA4	79.3 dBA	3/8" NPT	1/4" NPT	3/8" (10 mm) x qty. 2 1/2" (13 mm) x qty. 1	29 cfm (793 L/min)

Inline Air Nutrunners

Remote Start Shut-Off

QA6 Series

Accuracy, durability, and flexibility combine to maximize productivity.

Features

- Torque range: 8.9 – 40.6 ft-lbs (12 – 55 Nm)
- Speeds: 315 – 700 rpm
- Slim, compact design for space-saving fixturing
- Quick, precise shut-off limits scatter and torque reaction
- Integral cycle count port
- Lube-free motor
- Proven durability using world-class QE Series components
- Recommended for applications where precise torque control is required

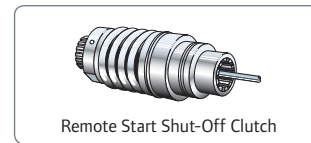

Service and Accessories

Manuals:

- 16601072
- 16601064
- 16601056

Accessories:

- Sockets, see form # IR-0506-016
- Piped away exhaust kit: QA6-K284
- Mounting flanges, see page 47

Kits:

- Remote housing kit: QA6-1R-K40
- Motor kit: QA6-1-K53
- Clutch ball kit: QA6-1-K581

Model	90 psi ft-lbs (Nm)	90 psi rpm	77 psi ft-lbs (Nm)	77 psi rpm	lbs (kg)	in (mm)	in (mm)	in
DC REMOTE START								
QA6ASRS025NF41S06	8.9 – 18.4 (12 – 25)	700	8.9 – 16.2 (12 – 22)	665	5.76 (2.61)	17.9" (454)	1.34" (34)	3/8" <input type="checkbox"/>
QA6ASRS030NF41S06	11.1 – 22.1 (15 – 30)	585	11.1 – 19.2 (15 – 26)	555	5.76 (2.61)	17.9" (454)	1.34" (34)	3/8" <input type="checkbox"/>
QA6ASRS040NF41S06	14.8 – 29.5 (20 – 40)	435	14.8 – 25.8 (20 – 35)	415	5.76 (2.61)	17.9" (454)	1.34" (34)	3/8" <input type="checkbox"/>
QA6ASRS055NF41S08	18.4 – 40.6 (25 – 55)	315	18.4 – 36.1 (25 – 49)	300	5.78 (2.62)	17.9" (454)	1.34" (34)	1/2" <input type="checkbox"/>

Series					
QA6	82.5 dBA	1/2" NPT	3/8" NPT	1/2" (13 mm) x qty. 3	36 cfm (1020 L/min)

QA8 Series

Accuracy, durability, and flexibility combine to maximize productivity.

Features

- Torque range: 14.8 – 132.8 ft-lbs (20 – 180 Nm)
- Speeds: 125 – 540 rpm
- Slim, compact design for space-saving fixturing
- Quick, precise shut-off limits scatter and torque reaction
- Integral cycle count port
- Lube-free motor
- Proven durability using world-class QE Series components
- Recommended for applications where precise torque control is required

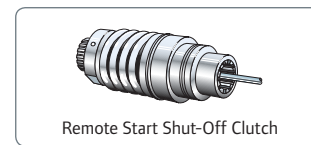

Service and Accessories

Manuals:

- 16601072
- 16601064
- 16601056

Accessories:

- Sockets, see form # IR-0506-016
- Piped away exhaust kit: QA6-K284
- Mounting flanges, see page 47

Kits:

- Remote housing tune-up kit: QA6-1R-K40
- Motor kit: QA6-1-K53
- Clutch ball kit: QA6-1-K581
- Housing kit: QA8-1-K40

Model	90 psi ft-lbs (Nm)	90 psi rpm	77 psi ft-lbs (Nm)	77 psi rpm	lbs (kg)	in (mm)	in (mm)	in
DC REMOTE START								
QA8ASRS040NF41S06	14.8 – 29.5 (20 – 40)	540	14.8 – 25.8 (20 – 35)	515	6.03 (2.73)	18.8" (478)	1.34" (34)	3/8" □
QA8ASRS040NF41S08	14.8 – 29.5 (20 – 40)	540	14.8 – 25.8 (20 – 35)	515	6.05 (2.74)	18.8" (478)	1.34" (34)	1/2" □
QA8ASRS055NF41S08	18.4 – 40.6 (25 – 55)	425	18.4 – 36.1 (25 – 49)	405	6.05 (2.74)	18.8" (478)	1.34" (34)	1/2" □
QA8ASRS070NF41S08	25.8 – 51.6 (35 – 70)	320	25.8 – 45.7 (35 – 62)	305	6.80 (3.09)	19.0" (482)	1.69" (43)	1/2" □
QA8ASRS090NF41S08	33.2 – 66.4 (45 – 90)	230	33.2 – 59.0 (45 – 80)	220	7.53 (3.42)	20.4" (518)	1.69" (43)	1/2" □
QA8ASRS115NF41S08	51.6 – 84.8 (70 – 115)	195	51.6 – 75.2 (70 – 102)	185	8.02 (3.64)	20.4" (517)	2.00" (51)	1/2" □
QA8ASRS150NF41S08	55.3 – 110.6 (75 – 150)	150	55.3 – 98.1 (75 – 133)	145	8.02 (3.64)	20.4" (517)	2.00" (51)	1/2" □
QA8ASRS180NF41S08	66.4 – 132.8 (90 – 180)	125	66.4 – 118.0 (90 – 160)	120	8.02 (3.64)	20.4" (517)	2.00" (51)	1/2" □

Series					
QA8	87 dBA	1/2" NPT	3/8" NPT	1/2" (13 mm) x qty. 3	46 cfm (1303 L/min)

Inline Air Nutrunners

Remote Start Stall

QA4 Series

Durability and flexibility combine to maximize productivity.

Features

- Torque Range: 8.8 – 33.9 ft-lbs (12 – 46 Nm)
- Speeds: 250 – 1,050 rpm
- Slim, compact design for space-saving fixturing
- Torque control through pressure regulation
- Lube-free motor
- Recommended for non-critical or pressure-controlled multi-spindle fixtured applications

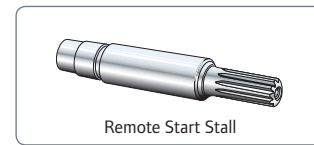

Service and Accessories

Manuals:

- 80160344
- 80160336
- 80217474

Accessories:

Sockets, see form # IR-0506-016
 Piped away exhaust kit: QA4-EXH-989
 Mounting flanges, see page 47

Kits:

Motor kit: QA4-1-K53
 Housing kit: QA4-1-K40

Model	90 psi ft-lbs (Nm)*	77 psi ft-lbs (Nm)	90 psi ft-lbs (Nm)	90 psi rpm	lbs (kg)	in (mm)	in (mm)	in
DC REMOTE START								
QA4ASRD012NF41S06	8.8 (12)	7.4 (10)	9.6 (13)	1050	3.55 (1.61)	17.8" (451)	0.81" (21)	3/8"
QA4ASRD015NF41S06	11.1 (15)	9.4 (12.7)	11.8 (16)	850	3.55 (1.61)	17.8" (451)	0.81" (21)	3/8" □
QA4ASRD020NF41S06	14.8 (20)	12.5 (17)	15.5 (21)	600	3.55 (1.61)	17.8" (451)	0.81" (21)	3/8" □
QA4ASRD027NF41S06	19.9 (27)	16.7 (22.7)	20.6 (28)	450	3.55 (1.61)	17.8" (451)	0.81" (21)	3/8" □
QA4ASRD046NF41S06	33.9 (46)	28 (38)	34.7 (47)	250	4.06 (1.84)	18.3" (465)	0.91" (23)	3/8" □
QA4ASRD046NF41S08	33.9 (46)	28 (38)	34.7 (47)	250	4.06 (1.84)	18.3" (465)	0.91" (23)	1/2" □

*Note: Highest recommended torque for assembly line applications. Exceeding the highest recommended torque repeatedly may result in reduced tool life.

Series					
QA4	79.3 dBA	3/8" NPT	1/4" NPT	3/8" (10 mm) x qty. 2 1/2" (13 mm) x qty. 1	29 cfm (793 L/min)

QA6 Series

Durability and flexibility combine to maximize productivity.

Features

- Torque Range: 18.4 – 40.6 ft-lbs (25 – 55 Nm)
- Speeds: 315 – 700 rpm
- Slim, compact design for space-saving fixturing
- Torque control through pressure regulation
- Lube-free motor
- Recommended for non-critical or pressure-controlled multi-spindle fixtured applications

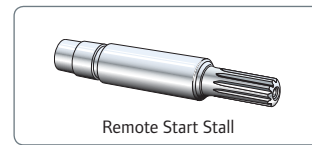

Service and Accessories

Manuals:

- 16601072
- 16601064
- 16601056

Accessories:

- Sockets, see form # IR-0506-016
- Piped away exhaust kit: QA6-K284
- Mounting flanges, see page 47

Kits:

- Housing kit: QA6-1-K40
- Motor kit: QA6-1-K53

Model	90 psi ft-lbs (Nm)*	77 psi ft-lbs (Nm)	90 psi ft-lbs (Nm)	90 psi rpm	lbs (kg)	in (mm)	in (mm)	in
DC REMOTE START								
QA6ASRD025NF41S06	18.4 (25)	16.2 (22)	19.9 (27)	700	5.76 (2.61)	17.9" (454)	1.34" (34)	3/8" □
QA6ASRD030NF41S06	22.1 (30)	19.2 (26)	23.6 (32)	585	5.76 (2.61)	17.9" (454)	1.34" (34)	3/8" □
QA6ASRD040NF41S06	29.5 (40)	25.8 (35)	31.7 (43)	435	5.76 (2.61)	17.9" (454)	1.34" (34)	3/8" □
QA6ASRD055NF41S08	40.6 (55)	36.1 (49)	44.2 (60)	315	5.78 (2.62)	17.9" (454)	1.34" (34)	1/2" □

*Note: Highest recommended torque for assembly line applications. Exceeding the highest recommended torque repeatedly may result in reduced tool life.

Series					
QA6	82.5 dBA	1/2" NPT	3/8" NPT	1/2" (13 mm) x qty. 3	36 cfm (1020 L/min)

Inline Air Nutrunners

Remote Start Stall

QA8 Series

Durability and flexibility combine to maximize productivity.

Features

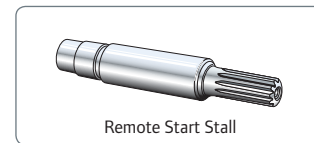

- Torque Range: 29.5 – 132.8 ft-lbs (40 – 180 Nm)
- Speeds: 125 – 540 rpm
- Slim, compact design for space-saving fixturing
- Torque control through pressure regulation
- Lube-free motor
- Recommended for non-critical or pressure-controlled multi-spindle fixtured applications



Remote Start Stall

Service and Accessories

Manuals:









-  16601072
-  16601064
-  16601056

Accessories:





Sockets, see form # IR-0506-016
Piped away exhaust kit: QA6-K284
Mounting flanges, see page 47

Kits:

Housing kit: QA8-1-K40
Motor kit: QA6-1-K53

Model	90 psi ft-lbs (Nm)*	77 psi ft-lbs (Nm)	90 psi ft-lbs (Nm)	90 psi rpm	lbs (kg)	in (mm)	in (mm)	in
DC REMOTE START								
QA8ASRD040NF41S06	29.5 (40)	25.8 (35)	34.7 (47)	540	6.03 (2.73)	18.8" (478)	1.34" (34)	3/8" 
QA8ASRD040NF41S08	29.5 (40)	25.8 (35)	34.7 (47)	540	6.05 (2.74)	18.8" (478)	1.34" (34)	1/2" 
QA8ASRD055NF41S08	40.6 (55)	36.1 (49)	44.2 (60)	425	6.05 (2.74)	18.8" (478)	1.34" (34)	1/2" 
QA8ASRD070NF41S08	51.6 (70)	45.7 (62)	59.0 (80)	320	6.80 (3.09)	19.0" (482)	1.69" (43)	1/2" 
QA8ASRD090NF41S08	66.4 (90)	59.0 (80)	78.2 (106)	230	7.53 (3.42)	20.4" (518)	1.69" (43)	1/2" 
QA8ASRD115NF41S08	84.8 (115)	75.2 (102)	93.7 (127)	195	8.02 (3.64)	20.4" (517)	2.00" (51)	1/2" 
QA8ASRD150NF41S08	110.6 (150)	98.1 (133)	120.2 (163)	150	8.02 (3.64)	20.4" (517)	2.00" (51)	1/2" 
QA8ASRD180NF41S08	132.9 (180)	118.0 (160)	143.1 (194)	125	8.02 (3.64)	20.4" (517)	2.00" (51)	1/2" 

*Note: Highest recommended torque for assembly line applications. Exceeding the highest recommended torque repeatedly may result in reduced tool life.

Series					
QA8	87 dBA	1/2" NPT	3/8" NPT	1/2" (13 mm) x 3	46 cfm (1303 L/min)



Pulse Tools

Torque Selection Guide

Non Shut-Off

Model	0 Nm	50 Nm	100 Nm	150 Nm	200 Nm	250 Nm	Referral page
100PQ1							128
46PQ1							127
Q70PQ1							126
46P3							127
180PQ1							128
Q80PQ1							126
Q70P3							126
280P							128
380P							128
Q80P3							126
500P							128
Q90P3							126
700P							128
Q110P4							126
900P							128
1100P							128
100P4							127
130P4							127
140P6							127

Shut-Off

Model	0 Nm	50 Nm	100 Nm	150 Nm	200 Nm	250 Nm	Referral page
40PSQ1							130
45PS3							130
55PS3							130
500PS3							131
70PS3							130
700PS3							131
90PS4							130
900PS4							131
1100PS4							131
1900PS4							131

Transducerized

Model	0 Nm	50 Nm	100 Nm	150 Nm	200 Nm	250 Nm	300 Nm	350 Nm	400 Nm	Referral page
QXP60P6										133
QXP70P6										133
QXP80P6										133
QXP90P6										133
QXP110P8										133
QXP120P8										133
QXP140P8										133
QXP150P8										133
YEX-120										134
YEX-150										134
YEX-501										134
YEX-701										134
YEX-901										134
YEX-1400										134
YEX-1900										134
YEX-3000										134
YED-200										134

Pistol Grip Pulse Tools

Non-Shut-Off

Q Series

Represents the latest generation of pulse tool technology engineered with the end-user in mind.



Features

- Torque range: 15 – 74 ft-lbs (20 – 100 Nm)
- Speeds: 5,500 – 7,000 rpm
- Easy torque adjustment for quick setup
- Extremely lightweight, compact, and fast
- World-class power-to-weight ratio
- Ergonomic design provides comfortable grip, low vibration and noise, and reactionless one-handed operation
- Environmentally enhanced lube-free, dual-chamber air motor, and self-lubricating blades and cylinder reduce oil mist
- Non-shut-off tools are recommended for the majority of applications where speed and ergonomics are important



Service and Accessories

Manuals:







-  80206618
-  80206667
-  80213671

Accessories:

- Sockets, see form # IR-0506-016
- QC qualifier, see page 132
- Spring balancer, see page 177

Kits:

- See page 137 for kits

Model	ft-lbs (Nm)	rpm	lb (kg)	in (mm)	in (mm)	in	cfm (L/min)	
TRIGGER START								
Q70PQ1	M6 – M8	15 – 20 (20 – 28)	7,000	1.8 (0.8)	5.2" (131)	0.9" (23)	1/4" 	12 (340)
Q70P3	M6 – M8	18 – 25 (24 – 35)	7,000	1.8 (0.8)	5.2" (131)	0.9" (23)	3/8" 	11 (311)
Q80PQ1	M8	18 – 25 (24 – 35)	7,000	1.9 (0.9)	5.4" (138)	0.9" (23)	1/4" 	12 (340)
Q80P3	M8	25 – 36 (34 – 50)	7,000	1.9 (0.9)	5.4" (138)	0.9" (23)	3/8" 	12 (340)
Q90P3	M8 – M10	35 – 48 (47 – 65)	6,500	2.1 (1.0)	5.8" (148)	0.9" (23)	3/8" 	14 (396)
Q110P4	M10 – M12	48 – 74 (65 – 100)	5,500	3.0 (1.4)	6.5" (164)	1.1" (27)	1/2" 	20 (566)

Model			
Q70P – Q80P	74 – 75 dBa	1/4" NPT	3/8" (10 mm)
Q90P – Q110P	78 – 81 dBa	1/4" NPT	3/8" (10 mm)

Power Pulse Plus

Ergonomic designs offer proven performance in high- and low-torque models.

Features

- Torque range: 10 - 174 ft-lbs (14 - 235 Nm)
- Speeds: 3200 - 8000 rpm
- Easy torque adjustment for quick setup
- High-speed, compact, lightweight design
- Excellent power-to-weight-ratio
- Two-speed trigger provides slow-speed starting and high-speed rundown
- Ergonomic design provides comfortable grip, low vibration and noise, and reactionless one-handed operation
- Non-shut-off tools are recommended for the majority of applications where speed and ergonomics are important



Service and Accessories

Manuals:

- 16574774
- 16574782
- 80167588
- 80167547

Accessories:

- Sockets, see form # IR-0506-016
- QC qualifier, see page 132
- Spring balancer, see page 177

Kits:

See page 137 for kits

Model	ft-lbs (Nm)	rpm	lb (kg)	in (mm)	in (mm)	in	cfm (L/min)	
DC TRIGGER START								
46PQ1	M5 - M6	10 - 18 (14 - 24)	8,000	2.0 (0.9)	7.3" (185)	0.7" (18)	1/4"	12 (340)
46P3	M5 - M6	8 - 21 (16 - 29)	8,000	2.0 (0.9)	7.3" (185)	0.7" (18)	3/8"	12 (340)
100P4	M12	48 - 107 (65 - 145)	4,000	4.7 (2.2)	7.4" (188)	1.3" (33)	1/2"	20 (566)
130P4	M14	56 - 141 (75 - 190)	3,600	5.8 (2.6)	7.9" (200)	1.3" (34)	1/2"	25 (708)
140P6	M16	78 - 174 (105 - 235)	3,200	6.8 (3.1)	8.9" (226)	1.4" (36)	3/4"	26 (736)

Model			
46P	78 dBA	1/4" NPT	3/8" (10 mm)
100P - 140P	82 dBA	1/4" NPT	1/2" (13 mm)

Pistol Grip Pulse Tools

Non-Shut-Off

Power Pulse

Performance-proven designs offer broad torque ranges for the ultimate in flexibility.

Features

- Torque range: 3 – 90 ft-lbs (4 – 122 Nm)
- Speeds: 5,000 – 10,500 rpm
- Easy torque adjustment for quick setup
- Broad torque coverage
- Two-speed trigger provides slow-speed starting and high-speed rundown
- Patented cooling system extends life
- Reactionless one-handed operation
- Non-shut-off tools are recommended for the majority of applications where speed and ergonomics are important



700P

Service and Accessories

Manuals:



















- 📖 16574790
- 📖 P7073us
- 📖 P7090us
- 📖 P7072us
- 📖 80167554
- 📖 P7074us



Accessories:

- Sockets, see form # IR-0506-016
- QC qualifier, see page 132
- Spring balancer, see page 177

Kits:

- See page 137 for kits

								
Model		ft-lbs (Nm)	rpm	lb (kg)	in (mm)	in (mm)	in	cfm (L/min)
DC TRIGGER START								
100PQ1	M4 – M5	3 – 8 (4 – 11)	9,300	1.6 (0.7)	5.6" (142)	0.7" (18)	1/4" 	12 (340)
180PQ1	M4 – M6	6 – 22 (8 – 30)	10,500	2.2 (1.0)	6.5" (165)	0.9" (23)	1/4" 	9 (255)
280PQ1	M6 – M8	10 – 26 (14 – 35)	9,500	2.5 (1.1)	7.0" (178)	0.9" (23)	1/4" 	11 (311)
280P	M6 – M8	12 – 28 (16 – 38)	9,500	2.5 (1.1)	7.0" (178)	0.9" (23)	3/8" 	11 (311)
380PQ1	M8	15 – 32 (20 – 44)	8,500	2.9 (1.3)	7.0" (178)	1.0" (26)	1/4" 	11 (311)
380P	M8	18 – 36 (24 – 49)	8,500	2.9 (1.3)	7.9" (178)	1.0" (26)	3/8" 	11 (311)
500PQ1	M8 – M10	18 – 38 (38 – 52)	8,500	3.2 (1.5)	6.5" (165)	1.2" (31)	1/4" 	12 (340)
500P	M8 – M10	20 – 43 (27 – 58)	8,500	3.2 (1.5)	6.5" (165)	1.2" (31)	3/8" 	12 (340)
700P	M8 – M10	24 – 58 (33 – 79)	8,500	3.6 (1.6)	6.5" (165)	1.2" (31)	3/8" 	14 (396)
900P	M10	30 – 80 (41 – 109)	7,500	4.6 (2.1)	7.9" (200)	1.3" (33)	1/2" 	14 (396)
1100P	M10 – M12	35 – 90 (48 – 122)	5,000	4.9 (2.2)	8.2" (208)	1.4" (36)	1/2" 	16 (453)

Model			
Power Pulse	76 – 78 dBA	1/4" NPT	3/8" (10 mm)

Inline / Angle Pulse Tools

Non-Shut-Off

Power Pulse





Performance-proven designs deliver in inline and space-constrained applications.

Features

- Torque range: 3 – 36 ft-lbs (4 – 49 Nm)
- Speeds: 5,500 – 10,000 rpm
- Easy torque adjustment for quick setup
- High-speed reactionless operation for space-constrained and inline applications
- Excellent power-to-weight ratio for more comfortable, convenient operation
- Non-shut-off tools are recommended for the majority of applications where speed and ergonomics are important

Service and Accessories

Manuals:

-  P7089us
-  P7075us
-  P7079us
-  P7062US















Accessories:



- Sockets, see form # IR-0506-016
- QC qualifier, see page 132
- Spring balancer, see page 177

Kits:

See page 137 for kits



								
Model	ft-lbs (Nm)	rpm	lb (kg)	in (mm)	in (mm)	in	cfm (L/min)	
DC INLINE LEVER START								
100SQ1	M4 – M5	3 – 9 (4 – 12)	10,000	1.8 (0.8)	8.9" (226)	0.8" (20)	1/4" 	12 (340)
180SQ1	M4 – M6	6 – 22 (8 – 30)	9,000	2.0 (0.9)	8.7" (221)	0.9" (23)	1/4" 	9 (255)
280SQ1	M6 – M8	7 – 26 (10 – 35)	8,000	2.1 (1.0)	9.0" (229)	0.9" (23)	1/4" 	11 (311)
380SQ1	M8	15 – 32 (20 – 44)	8,500	2.6 (1.2)	9.1" (231)	1.0" (25)	1/4" 	11 (311)
DC ANGLE LEVER START								
500A	M6 – M8	12 – 30 (16 – 41)	7,000	3.3 (1.5)	10.5" (267)	1.1" (27)	3/8" 	11 (311)
700A	M8 – M10	19 – 36 (26 – 49)	5,500	4.4 (2.0)	11.2" (284)	1.1" (27)	3/8" 	12 (340)

Model			
Power Pulse	76 – 83 dBA	1/4" NPT	3/8" (10 mm)

Pistol Grip Pulse Tools

Shut-Off

Power Pulse Plus

Ergonomic designs offer proven performance and error-proofing.

Features

- Torque range: 4 – 59 ft-lbs (5 – 78 Nm)
- Speeds: 5,000 – 7,000 rpm
- Easy torque adjustment for quick setup
- Auto-shut-off feature stops airflow to tool when cycle is complete
- High-speed, compact, lightweight design
- Ergonomic design provides comfortable grip, low vibration and noise, and reactionless one-handed operation
- Auto-shut-off limits air consumption and tool wear
- Deters early throttle release; recommended when improved error-proofing is desired

Service and Accessories

Manuals:

- 16574766
- 80167570

Accessories:



Sockets, see form # IR-0506-016
QC qualifier, see page 132
Spring balancer, see page 177

Kits:

See page 137 for kits



Model	ft-lbs (Nm)	rpm	lb (kg)	in (mm)	in (mm)	in	cfm (L/min)
DC TRIGGER START							
40PSQ1	M4 – M5	4 – 10 (5 – 13)	5,000	2.1 (1.0)	7.2" (183)	0.73" (19)	1/4" 13 (368)
45PS3	M5 – M6	6 – 14 (8 – 20)	7,000	2.4 (1.1)	7.3" (185)	0.83" (21)	3/8" 12 (340)
45PSQ1	M5 – M6	5 – 13 (7 – 17)	7,000	2.4 (1.1)	7.3" (185)	0.83" (21)	1/4" 12 (340)
55PS3	M6 – M8	7 – 21 (10 – 28)	6,000	2.4 (1.1)	7.3" (185)	0.83" (21)	3/8" 15 (425)
55PSQ1	M6 – M8	6 – 16 (8 – 22)	6,000	2.4 (1.1)	7.3" (185)	0.83" (21)	1/4" 15 (425)
70PS3	M8 – M10	26 – 42 (36 – 58)	5,500	3.5 (1.6)	8.1" (206)	0.97" (25)	3/8" 17 (481)
90PS4	M10 – M12	37 – 59 (51 – 78)	5,000	4.4 (2.0)	7.9" (201)	1.15" (29)	1/2" 18 (510)

Model			
40PS – 55PS	70 – 76 dBA	1/4" NPT	3/8" (10 mm)
70PS – 90PS	82 – 85 dBA	1/4" NPT	3/8" (10 mm)

Power Pulse

Performance-proven designs offer broad torque ranges for ultimate flexibility.

Features

- Torque range: 10 – 140 ft-lbs (14 – 190 Nm)
- Speeds: 6,500 – 10,500 rpm
- Easy torque adjustment for quick setup
- Auto-shut-off feature stops airflow to tool when cycle is complete
- Broad torque coverage
- Two-speed trigger provides slow-speed starting and high-speed rundown
- Auto-shut-off limits air consumption and tool wear
- Deters early throttle release; recommended when improved error-proofing is desired



Service and Accessories

Manuals:

- P7191us
- P7192us

Accessories:

- Sockets, see form # IR-0506-016
- QC qualifier, see page 132
- Spring balancer, see page 177

Kits:

See page 137 for kits

Model	ft-lbs (Nm)	rpm	lb (kg)	in (mm)	in (mm)	in	cfm (L/min)	
DC TRIGGER START								
500PS3	M6 – M8	10 – 40 (14 – 54)	10,500	4.0 (1.8)	7.9" (201)	1.2" (30)	3/8" □	12 (340)
700PS3	M8 – M10	20 – 60 (27 – 81)	9,250	4.5 (2.0)	8.5" (216)	1.2" (30)	3/8" □	14 (396)
900PS4	M10	30 – 70 (41 – 95)	8,000	5.9 (2.7)	9.1" (231)	1.3" (33)	1/2" □	14 (396)
1100PS4	M10 – M12	40 – 85 (54 – 115)	6,500	6.2 (2.8)	9.2" (234)	1.3" (33)	1/2" □	16 (453)
1900PS4	M12 – M14	70 – 140 (108 – 190)	7,000	8.6 (3.9)	10.2" (259)	1.5" (38)	1/2" □	18 (510)

Model			
Power Pulse	77 – 82 dBA	1/4" NPT	3/8" (10 mm)

Air Tool Qualifiers

QC Qualifier

Error-proofing and process control for shut-off and non-shut-off tools.

Process Qualification

- Provides OK / NOK signal based on air flow rundown signature
- Verifies batch / gang count and cycle time completion
- Optional hose light gives operator visual feedback right at the tool
- I/O ports interface with alarms, lights, and process control devices
- Total cycle count alarm prompts for preventive maintenance

Error-Proofing

- Detects rehits, cross-threads, and early throttle release

Easy Setup

- Simple menu prompts quickly to lead users through setup

Shut-Off Capability

- Solenoid valve provides shutoff capability on non-shut-off tools

Tool Compatibility

- No tool modifications are required (such as special valves, porting)
- Independent of brand — see manual for tool compatibility list

Recommended when additional error-proofing, operator feedback and process control are required.

Service and Accessories

Manuals:

-  45520624
-  45499555

Accessories:

- Hose light, see page 138
- Spring balancers, see page 177



Model	OK / NOK	Batch Count	Batch Timing	Error-Proofing	I/O	Parameter Sets	Comm Protocol	Solenoid Valve
FOR USE WITH NON-SHUT-OFF TOOLS								
QC100-S-K	●	●	●	●	●	2	—	●
QC100-N-K	●	●	●	●	●	2	PFCS	●
FOR USE WITH SHUT-OFF TOOLS								
QC200-S-K	●	●	●	●	●	2	—	—
QC200-N-K	●	●	●	●	●	2	PFCS	—

Pistol Grip Pulse Tools

Transducerized

QXP Series

Combine the power and ergonomics of the latest generation of reactionless pulse tools with closed-loop electronic control to maximize productivity in torque-critical applications.

Features

- Torque range: 7.4 – 162 ft-lbs (10 – 220 Nm)
- Speeds: 4,200 – 7,000 rpm
- Extremely compact, lightweight, ergonomic design
- World-class power-to-weight ratio
- Reactionless, high-speed operation
- Accurate, adjustable closed-loop torque control
- Low noise and vibration
- Visible and audible feedback
- Recommended for applications requiring data output, closed-loop torque accuracy, process control, and operator feedback

Service and Accessories

Manuals:

- 80206642
- 80206675
- 80194574

Accessories:







Impact sockets, see form # IR-0506-016
Spring balancers, see page 177



Kits:

See page 137 for kits



QXP110P8

							
Model		ft-lbs (Nm)	rpm	lb (kg)	in (mm)	in (mm)	Drive
DC TRIGGER START							
QXP60P6	M6	7.4 – 14.5 (10 – 19.5)	6,000	2.8 (1.26)	7.0" (179)	0.8" (21.0)	3/8" □
QXP60Q4	M6	6.3 – 11.8 (8 – 16)	6,000	2.8 (1.26)	7.0" (179)	0.8" (21.0)	1/4" Ⓞ
QXP70P6	M6 – M8	13 – 24 (18 – 33)	7,000	2.8 (1.26)	7.0" (179)	0.8" (21.0)	3/8" □
QXP70Q4	M6 – M8	11 – 20 (15 – 27)	7,000	2.8 (1.26)	7.0" (179)	0.8" (21.0)	1/4" Ⓞ
QXP80P6	M8	17 – 33 (24 – 46)	7,000	3.0 (1.3)	7.3" (186)	0.8" (21.0)	3/8" □
QXP90P6	M8 – M10	26 – 44 (35 – 60)	6,500	3.3 (1.50)	7.7" (195)	0.9" (23.0)	3/8" □
QXP110P8	M10 – M12	35 – 70 (48 – 95)	5,500	4.1 (1.86)	8.2" (209)	1.0" (25.6)	1/2" □
QXP120P8	M12	48 – 92 (65 – 125)	5,900	5.4 (2.46)	8.8" (223)	1.1" (29.0)	1/2" □
QXP140P8	M14	55 – 114 (75 – 155)	5,200	6.3 (2.86)	9.3" (235)	1.1" (29.0)	1/2" □
QXP150P8	M16	81 – 162 (110 – 220)	4,200	7.5 (3.41)	9.6" (241)	1.3" (32.5)	1/2" □

Series			
QXP	75 – 87 dBA	1/4" NPT	3/8" (10 mm)

Pistol Grip Pulse Tools

Transducerized

YE Classic Series

Combine the power and ergonomics of reactionless pulse tools with closed-loop electronic control to maximize productivity in torque-critical applications.

Features

- Torque range: 2.6 – 265 ft-lbs (3.5 – 360 Nm)
- Speeds: 2,300 – 9,000 rpm
- Excellent power-to-weight ratio
- Reactionless, high-speed operation
- Accurate, adjustable closed-loop torque control
- Low noise and vibration
- Recommended for applications requiring data output, closed-loop torque accuracy, process control, and operator feedback

Service and Accessories

Manuals:

-  P7584
-  P7371













Accessories:



Impact sockets, see form # IR-0506-016
Spring balancers, see page 177

Kits:

See page 137 for kits



Model		ft-lbs (Nm)	rpm	lb (kg)	in (mm)	in (mm)	Drive
DC TRIGGER START							
YEX-120A	M5 – M6	2.6 – 6.5 (3.5 – 8.8)	7,000	3.2 (1.43)	8.8" (223)	0.93" (23.5)	1/4" 
YEX-120	M5 – M6	2.9 – 7.2 (3.9 – 9.8)	7,000	3.2 (1.43)	8.7" (222)	0.93" (23.5)	3/8" 
YEX-150A	M5 – M6	3.6 – 11.1 (4.9 – 15)	9,000	3.2 (1.43)	8.8" (223)	0.91" (23.0)	1/4" 
YEX-150	M5 – M6	4.0 – 13.3 (5.4 – 18)	9,000	3.2 (1.43)	8.7" (222)	0.91" (23.0)	3/8" 
YEX-501A	M6 – M8	11.1 – 31.7 (15 – 43)	8,200	4.4 (2.0)	8.9" (227)	1.04" (26.5)	1/4" 
YEX-501	M6 – M8	12.5 – 35 (17 – 48)	8,200	4.4 (2.0)	9.4" (234)	1.04" (26.5)	3/8" 
YEX-701	M8 – M10	18.4 – 55 (25 – 75)	8,000	4.9 (2.2)	9.7" (246)	1.04" (26.5)	3/8" 
YEX-901	M10	23.6 – 65 (32 – 88)	6,100	5.9 (2.7)	10.1" (257)	1.32" (33.5)	1/2" 
YEX-1400	M10 – M12	38 – 105 (52 – 142)	5,900	7.7 (3.5)	10.5" (266)	1.34" (34.0)	1/2" 
YEX-1900	M12	43 – 123 (58 – 167)	5,800	9.0 (4.1)	10.9" (277)	1.54" (39.0)	1/2" 
YEX-3000	M16	90 – 209 (122 – 284)	4,000	14.1 (6.4)	12.2" (309)	1.57" (40.0)	3/4" 
YED-200	M18 – M20	129 – 265 (175 – 360)	2,300	15.0 (6.8)	12.0" (307)	1.60" (40.0)	3/4" 

Series			
YEX	74 – 80 dBA	1/4" NPT	3/8" (10 mm)
YED	86 dBA	1/2" NPT	1/2" (13 mm)

Inline Pulse Tools

Transducerized

YE Classic Series

Combine the power and ergonomics of reactionless pulse tools with closed-loop electronic control to maximize productivity in torque-critical applications.

Features

- Torque range: 2.7 – 45 ft-lbs (3.6 – 61 Nm)
- Speeds: 7,500 – 10,000 rpm
- Excellent power-to-weight ratio
- Reactionless, high-speed operation
- Accurate, adjustable closed-loop torque control
- Low noise and vibration
- Recommended for applications requiring data output, closed-loop torque accuracy, process control, and operator feedback



Service and Accessories

Manuals:



P7371

Accessories:

Sockets, see form # IR-0506-016
Spring balancers, see page 177

Kits:

See page 137 for kits

Model		ft-lbs (Nm)	rpm	lb (kg)	in (mm)	in (mm)	Drive
DC TRIGGER START							
YEX-120SA	M5 – M6	2.7 – 5.3 (3.6 – 7.2)	10,000	2.6 (1.18)	10.5" (267)	1.22" (31.0)	1/4"
YEX-120S	M5 – M6	3.0 – 5.6 (4.0 – 7.6)	10,000	2.6 (1.18)	10.5" (267)	1.22" (31.0)	3/8"
YEX-150SA	M5 – M6	3.6 – 11 (4.9 – 15)	9,000	3.0 (1.43)	10.9" (276)	0.91" (23.0)	1/4"
YEX-150S	M5 – M6	4.0 – 13 (5.4 – 18)	9,000	3.2 (1.45)	10.8" (275)	0.91" (23.0)	3/8"
YEX-300SA	M6	5.8 – 15 (7.8 – 20)	8,000	4.0 (1.80)	12.3" (313)	1.06" (27.0)	1/4"
YEX-300S	M6	6.5 – 16 (8.8 – 22)	8,000	4.0 (1.80)	12.3" (313)	1.06" (27.0)	3/8"
YEX-500SA	M6 – M8	8.1 – 27 (11 – 37)	7,800	4.6 (2.10)	13.2" (334)	1.06" (27.0)	1/4"
YEX-500S	M6 – M8	9.6 – 30 (13 – 41)	7,800	4.6 (2.10)	13.1" (333)	1.06" (27.0)	3/8"
YEX-700S	M8	14.8 – 45 (20 – 61)	7,500	5.1 (2.30)	13.1" (333)	1.06" (27.0)	3/8"

Series			
YEX	74 – 80 dBA	1/4" NPT	3/8" (10 mm)

Controllers

YETC-200 Series

Combine the power and ergonomics of reactionless pulse tools with closed-loop electronic control to maximize productivity in torque-critical applications.

Features

- Easy setup and programming of up to 8 parameter groups
- Closed-loop torque control for QXP and YE Series tools
- Torque readout and data output
- Detects rehits, cross-threads, and early throttle release
- Cycle and batch OK/NOK signals
- I/O for process flow control
- Advanced tightening strategies available
- Recommended for applications requiring data output, closed-loop torque accuracy, process control, and operator feedback

Programmable parameters:

- Maximum torque
- Minimum torque
- Target torque
- Threshold torque
- Tool coefficient
- Fast error (pre-tightened)
- Slow error (cross thread)
- Gang control
- Additional advanced parameters



Additional Equipment

Standard equipment:







Controller	
10-meter tool cable	Y-7642-0908-0117
Solenoid valve	
Tool air hose with quick couplers	
Air regulator	

Optional equipment:

15-meter tool cable	Y-7642-0908-0119
20-meter extension tool cable	Y-7642-0908-0122
3/8" solenoid valve	Y-9191-1026-0000
1/2" solenoid valve	YETV-12KIT
Printer	Y-CTZ

Manuals:

- P7395
- P7396

Model	 in (mm)	 in (mm)	 in (mm)	 lb (kg)	 volts	Configs	
YETC-200ETB	9" (230)	4.3" (110)	11.4" (290)	11.4 (5.2)	117 V AC	8	1
YETC-200ETB-4	9" (230)	4.3" (110)	11.4" (290)	11.4 (5.2)	117 V AC	4 x 2	4
YETC-200ETF	9" (230)	4.3" (110)	11.4" (290)	11.4 (5.2)	117 V AC	8	1

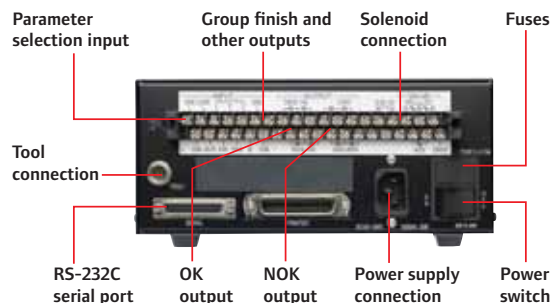
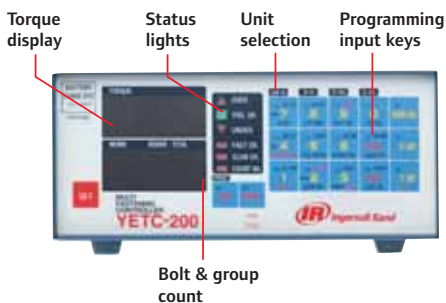

Pulse Tools

Accessories

Pulse Tune-Up Kits

Model	Motor Kit	Mechanism Kit	Repair Kit
SHUT-OFF PULSE TOOLS			
POWER PULSE PLUS			
40PSQ1	40PSQ1-TK1	40PSQ1-TKMS1	45PS-99
45PS3	45PS3-TK1	45PS3-TKMS1	45PS-99
45PSQ1	45PS3-TK1	45PS3-TKMS1	45PS-99
55PS3	55PS3-TK1	45PS3-TKMS1	45PS-99
55PSQ1	55PS3-TK1	45PS3-TKMS1	45PS-99
70PS3	70PS3-TK1	70PS3-TKMS1	45PS-99
90PS4	90PS4-TK1	90PS4-TKMS1	90PS-99
POWER PULSE			
500PS3	500PS3-K500	500PS3-K600	700A-99
700PS3	700PS3-K500	500PS3-K600	700A-99
900PS4	900PS4-K500	900PS4-K600	700A-99
1100PS4	1100PS4-K500	1100PS4-K600	700A-99
1900PS4	1900P-K500A	1900P-K600A	1900P-99
NON-SHUT-OFF PULSE TOOLS			
POWER PULSE PLUS			
46P3	46P-TK1	46P-TKMS1	46P-99
46PQ1	46P-TK1	46P-TKMS1	46P-99
Q70PQ1	Q70P-TK1	Q70P-TKMS1	N/A
Q70P3	Q70P-TK1	Q70P-TKMS1	N/A
Q80PQ1	Q70P-TK1	Q70P-TKMS1	N/A
Q80P3	Q70P-TK1	Q70P-TKMS1	N/A
Q90P3	Q70P-TK1	Q70P-TKMS1	N/A
Q110P4	Q110P-TK1	Q110P-TKMS1	N/A
100P4	100P4-TK1	100P4-TKMS1	100P4-99
130P4	130P4-TK1	130P4-TKMS1	130P4-99
140P6	140P6-TK1	140P6-TKMS1	140P6-99

Model	Motor Kit	Mechanism Kit	Repair Kit
NON-SHUT-OFF PULSE TOOLS			
POWER PULSE			
100PQ1	100PQ-K500	100PQ-K600	100PQ-99
180PQ1	180PQ-K500	180PQ-K600A	180PQ-99
280PQ1	280PQ-K500	180PQ-K600A	180PQ-99
280P	280PQ-K500	180PQ-K600A	180PQ-99
380PQ1	380PQ-K500	380PQ-K600A	180PQ-99
380P	380PQ-K500	380PQ-K600A	180PQ-99
500PQ1	500P-K500	500P-K600	700A-99
500P	500P-K500	500P-K600	700A-99
700P	700P-K500	500P-K600	700A-99
900P	900P-K500	900P-K600A	700A-99
1100P	1100PS4-K500	900P-K600A	700A-99
INLINE			
100SQ1	100SQ-K500	100PQ-K600	100PQ-99
180SQ1	180PQ-K500	180PQ-K600A	180PQ-99
280SQ1	280PQ-K500	180PQ-K600A	180PQ-99
380SQ1	380PQ-K500	380SQ-K600A	180PQ-99
ANGLE			
500A	500A-K500	500A-K600	180PQ-99
700A	700A-K500	700A-K600	700A-99
QXP SERIES TRANSDUCERIZED PULSE			
Models 70/80/90	Q70P-TK1	Q70P-TKMS1	N/A
Models 110	Q110P-TK1	Q110P-TKMS1	N/A

Pulse Tools

Accessories

Hose Lights

Model	Description
QXLH-16-14	8' (2.4 m) hose and light with 1/4" fittings
QXLH-13-14	16' (4.8 m) hose and light with 1/4" fittings
QXLH-25-14	25' (7.6 m) hose and light with 1/4" fittings
QXLH-16-38	16' (4.8 m) hose and light with 3/8" fittings
QXLH-25-38	25' (7.6 m) hose and light with 3/8" fittings



QC & QXC Hose Light

Literature

Catalog Name	Form Number
Pulse Tools	SW041107

Protective Boots

Model	Boot Part Number
100P4	100P4-P32
130P4	130P4-P32
46P3, 46PQ1	46P3-941
45PS3, 45PSQ1, 55PS3, 55PSQ1	55PS3-P32
70PS3	70PS3-P32
90PS4	90PS4-P32
140P6	140P6-P32
40PSQ1	40PSQ1-P32
Q70P3, Q70PQ1	Y-0189-0029-0000
Q80P3, Q80PQ1	Y-0191-0029-0000
Q90P3	Y-0188-0029-0000
Q110P4	Y-0190-0029-0000
QXP70P6, QXP70Q4, QXP90P6	Y-0186-0029-0000
QXP110P8	Y-0187-0029-0000
QXP120P8	Y-0323-0029-0000
QXP140P8	Y-0341-0029-0000



Protective Boots

Air Production Drills

Compact size, ergonomics, excellent power-to-weight ratios, and durability distinguish the Ingersoll Rand line of air drills for production and maintenance applications. Choose from our broad range of models, including inline, angle, flat head, pistol, and modular drills to meet your exact requirements. All drills for production applications share key features such as double row ball bearing construction, which assures a maximum TIR of 0.005" for precise, concentric holes.

**140**

Pistol Grip Drills

**154**

Inline Handle Drills

**161**

Angle Head Drills

**169**

Modular Drills



Air Production Drills

Torque Selection Guide

Pistol Grip

Model	0	2 Nm	4 Nm	6 Nm	8 Nm	10 Nm	20 Nm	40 Nm	60 Nm	70 Nm	Referral page
6ADST4	■										149
DG021B-64-A	■										145
QP511LD	■										143
7ADST4	■										150
QP381D	■	■									143
DG022B-26-A	■	■									144
1AL1	■	■									142
QP301LD / QP302LD	■	■									143
DG021B-33-A	■	■									144
1P38ST4	■	■	■								142
5AHST4	■	■	■								148
DG052B-50-B	■	■	■								146
QP201D / QP202D	■	■	■								143
6AJST4	■	■	■								149
DG051B-52-A	■	■	■								147
QP151D / QP152D	■	■	■								143
5AKST4	■	■	■								148
728JA1	■	■	■								153
5RALST6	■	■	■	■							148
7AJST4	■	■	■	■							150
DG051B-33-A	■	■	■	■							147
DG052B-25-B	■	■	■	■							146
6AKST4	■	■	■	■							149
7845-E	■	■	■	■							151
DG022B-8-A	■	■	■	■							144
7AJJST4	■	■	■	■							150
QP091D	■	■	■	■							143
DG021B-10-A	■	■	■	■							145
728LA2	■	■	■	■							153
6ALST4	■	■	■	■	■						149
1P09ST4	■	■	■	■	■						142
7ALST6	■	■	■	■	■						150
5ANST6	■	■	■	■	■						148
8509-ADB	■	■	■	■	■						152
QP051D / QP052D	■	■	■	■	■						143
DG052B-10-A	■	■	■	■	■						146
DG022B-4-A	■	■	■	■	■						144
DG051B-15-A	■	■	■	■	■						147
1P06ST4	■	■	■	■	■						142
DG021B-5-A	■	■	■	■	■						145
8506-ADB	■	■	■	■	■						152
DG051B-11-A	■	■	■	■	■						147
728NA3	■	■	■	■	■						153
7ANST8	■	■	■	■	■						150
7847-E	■	■	■	■	■						151
6ARST6	■	■	■	■	■						149
DG052B-4-B	■	■	■	■	■						146
6ASST6	■	■	■	■	■						149
DG051B-4-A	■	■	■	■	■						147
7849-E	■	■	■	■	■						151

Inline

Model	0	2 Nm	4 Nm	6 Nm	8 Nm	10 Nm	20 Nm	30 Nm	40 Nm	Referral page
DL021B-220-A										156
DL021B-64-A										156
QS511D										154
7850-E										160
QS381D										154
DL022B-26-A										155
DL021B-33-A										156
QS301D										154
5LJ1										159
6LH1										159
DL021B-19-A										156
QS151D										154
DL052B-30-A										157
5LL1										159
6LK1										159
DL022B-8-A										155
DL052B-15-B										157
5LN3										159
DL051B-15-A										158
DL052B-6-B										157
6LR3										159
7854-E										160

Angle

Model	0	2 Nm	4 Nm	6 Nm	8 Nm	10 Nm	20 Nm	30 Nm	40 Nm	Referral page
DR021B-50-A										163
1LL1A1										161
QA3559D										162
5LH1B1										165
DR053B-52-T										164
QA1739D										162
DR021B-15-A										163
QA1219D										162
DR051B-28-A										164
6LK1A1										166
7441-D										168
DR023B-11-E										163
QA0854D										162
7LK1A1										167
QA0859D										162
DR021B-7-A										163
DR023B-5-C										163
QA0539D										162
DR051B-11-A										164
5LN2A43										165
7LN3A44										167
DR051B-4-A										164
6LR3A44										166

Air Production Drills

Pistol Grip

1 Series



1 Series drills combine proven quality and performance with economy for day-in day-out production drilling.

Features

- Stall Torque: 20 – 100 in-lbs (2.3 – 11.3 Nm)
- Speeds: 600 – 3800 rpm
- Power: 0.15 – 0.19 hp
- Double row ball bearings construction assures max TIR of 0.005" for precise, concentric holes
- Variable speed control allows slow starting and high speed for fast drilling
- Excellent power-to-weight ratio gets the job done with less fatigue

Service and Accessories

Manuals:

-  16572760
-  16572661
-  16572059

Accessories:







Horizontal hanger: 3RA-365
Chuck: R0H-99
Spindle accessories, see page 185

Kits:

Tune-up kit: 3A-TK2



1P38ST4

							
Model	in-lbs (Nm)	rpm	lbs (kg)	in (mm)	in (mm)	in (mm)	cfm (L/min)
C TRIGGER START							
1P38ST4	20.4 (2.3)	3,800	1.4 (0.6)	6.3" (159)	1/4" (6.0)	0.7" (17)	11 (311)
1AL1	15 (1.7)	2,800	1.4 (0.6)	6.3" (159)	1/4" (6.0)	0.7" (17)	11 (311)
1P09ST4	67.3 (7.6)	900	1.5 (0.7)	6.7" (171)	1/4" (6.0)	0.7" (17)	11 (311)
1P06ST4	100 (11.3)	600	1.5 (0.7)	6.7" (171)	1/4" (6.0)	0.7" (17)	11 (311)

Model				
1AL1	0.15 hp	73 dBa	1/4" NPT	1/4" (6 mm)
1P	0.19 hp	73 dBa	1/4" NPT	1/4" (6 mm)

Q2 Series

Compact and light weight, Q2 drills deliver more power in a smaller package to get the job done in less time.

Features

- Stall torque: 9.7 – 86.4 in-lbs (1.1 – 9.8 Nm)
- Speeds: 500 – 5100 rpm
- Compact and lightweight, this tool delivers more power in a smaller package to get the job done in less time
- Variable speed control allows slow starting and high speed for fast drilling
- Ergonomic design reduces operator fatigue
- Excellent power-to-weight ratio gets the job done with less fatigue

Service and Accessories

Manuals:

- 16572745
- 16572034
- 16572679

Accessories:

- Horizontal hanger: 3RA-365
- Chuck: R0H-99
- Spindle accessories, see page 185

Kits:

- Tune-up kit: Q2-PDRILL-TK1



QP151D

	Max. Nm	1 min. rpm	lbs (kg)	in (mm)	Max. in (mm)	in (mm)	cfm (L/min)
C TRIGGER START							
QP511LD	9.7 (1.1)	5,100	1.4 (0.7)	6.7" (171)	1/4" (6)	0.6" (15)	16 (450)
QP381D	13.3 (1.5)	3,800	1.5 (0.7)	7.2" (184)	1/4" (6)	0.6" (15)	16 (450)
QP301LD	15.9 (1.8)	3,000	1.4 (0.7)	6.7" (171)	1/4" (6)	0.6" (15)	16 (450)
QP302LD	15.9 (1.8)	3,000	1.7 (0.8)	6.7" (171)	3/8" (10)	0.7" (18)	16 (450)
QP201D	24.8 (2.8)	2,000	1.5 (0.7)	7.2" (184)	1/4" (6)	0.6" (15)	16 (450)
QP202D	24.8 (2.8)	2,000	1.8 (0.8)	7.2" (184)	3/8" (10)	0.7" (18)	16 (450)
QP151D	30.1 (3.4)	1,500	1.5 (0.7)	7.2" (184)	1/4" (6)	0.6" (15)	16 (450)
QP152D	30.1 (3.4)	1,500	1.8 (0.8)	7.2" (184)	3/8" (10)	0.7" (18)	16 (450)
QP091D	51.3 (5.8)	900	1.5 (0.7)	7.2" (184)	1/4" (6)	0.6" (15)	16 (450)
QP051D	86.4 (9.8)	500	1.5 (0.7)	7.2" (184)	1/4" (6)	0.6" (15)	16 (450)
QP052D	86.4 (9.8)	500	1.8 (0.8)	7.2" (184)	3/8" (10)	0.7 (18)	16 (450)

Series				
Q2	0.25 hp	75 dBa	1/4" NPT	1/4" (6 mm)

Air Production Drills

Pistol Grip

20 Series

20 Series drills offer impressive power-to-weight ratio in a classic, comfortable design.

Features

- Stall torque: 2.4 – 106.8 in-lbs (0.3 – 12 Nm)
- Speeds: 400 – 22,000 rpm
- Power: 0.25 hp (0.18 kW)
- High-performance motor delivers increased speed and power for fast, smooth hole drilling
- Ergonomically correct handle styling and lightweight, compact size enhance operator comfort
- Responsive two-stage trigger provides optimum control when starting a hole
- Excellent power-to-weight ratio gets the job done with less fatigue

Service and Accessories

Manuals:

- 49999065
- 49999471

Accessories:

- Horizontal hanger: 3RA-365
- Suspension bail: 47795
- Spindle accessories, see page 185
- Swivel air inlet, see page 186

Kits:

- Service kit: 47755



DG021B-33-A

Model	in-lbs (Nm)	rpm	lbs (kg)	in (mm)	in (mm)	in (mm)	cfm (L/min)
DC TRIGGER START							
DG022B-50-A	7.2 (0.8)	5,000	1.5 (0.7)	5.7" (146)	1/4" (6)	0.7" (17)	15 (420)
DG022B-26-A	14.4 (1.6)	2,600	1.5 (0.7)	5.7" (146)	1/4" (6)	0.7" (17)	15 (420)
DG022B-26-P	14.4 (1.6)	2,600	1.5 (0.7)	5.7" (146)	*	0.7" (17)	15 (420)
DG022B-15-A	25.2 (2.8)	1,500	1.6 (0.8)	6.1" (155)	1/4" (6)	0.7" (17)	15 (420)
DG022B-15-B	25.2 (2.8)	1,500	1.6 (0.8)	6.1" (155)	3/8" (10)	0.7" (17)	15 (420)
DG022B-15-L	25.2 (2.8)	1,500	1.6 (0.8)	6.1" (155)	3/8" (10)**	0.7" (17)	15 (420)
DG022B-15-P	25.2 (2.8)	1,500	1.6 (0.8)	6.1" (155)	*	0.7" (17)	15 (420)
DG022B-8-A	49.2 (5.5)	800	1.6 (0.8)	6.1" (155)	1/4" (6)	0.7" (17)	15 (420)
DG022B-8-B	49.2 (5.5)	800	1.6 (0.8)	6.1" (155)	3/8" (10)	0.7" (17)	15 (420)
DG022B-8-P	49.2 (5.5)	800	1.6 (0.8)	6.1" (155)	*	0.7" (17)	15 (420)
DG022B-4-A	96 (11)	400	1.6 (0.8)	6.1" (155)	1/4" (6)	0.7" (17)	15 (420)
DG022B-4-P	96 (11)	400	1.6 (0.8)	6.1" (155)	*	0.7" (17)	15 (420)







* No Chuck

** Keyless Chuck: 3/8" (10 mm)

(continued next page)





Series					
20	0.25 hp	76 dBa	1/4" NPT	5/16" (8mm)	3/8"-24*

20 Series (continued)

							
Model	in-lbs (Nm)	rpm	lbs (kg)	in (mm)	in (mm)	in (mm)	cfm (L/min)
C TRIGGER START							
DG021B-220-A	2.4 (0.3)	22,000	1.5 (0.7)	5.7" (146)	1/4" (6)	0.7" (17)	15 (420)
DG021B-220-P	2.4 (0.3)	22,000	1.5 (0.7)	5.7" (146)	*	0.7" (17)	15 (420)
DG021B-64-A	8.4 (1.0)	6,400	1.5 (0.7)	5.7" (146)	1/4" (6)	0.7" (17)	15 (420)
DG021B-64-P	8.4 (1.0)	6,400	1.5 (0.7)	5.7" (146)	*	0.7" (17)	15 (420)
DG021B-33-A	15.6 (1.8)	3,300	1.5 (0.7)	5.7" (146)	1/4" (6)	0.7" (17)	15 (420)
DG021B-33-P	15.6 (1.8)	3,300	1.5 (0.7)	5.7" (146)	*	0.7" (17)	15 (420)
DG021B-19-A	27.6 (3.0)	1,900	1.6 (0.8)	6.1" (155)	1/4" (6)	0.7" (17)	15 (420)
DG021B-19-B	27.6 (3.0)	1,900	1.6 (0.8)	6.1" (155)	3/8" (10)	0.7" (17)	15 (420)
DG021B-10-A	54.0 (6.0)	1,000	1.6 (0.8)	6.1" (155)	1/4" (6)	0.7" (17)	15 (420)
DG021B-10-B	54.0 (6.0)	1,000	1.6 (0.8)	6.1" (155)	3/8" (10)	0.7" (17)	15 (420)
DG021B-5-A	106.8 (12)	500	1.6 (0.8)	6.1" (155)	1/4" (6)	0.7" (17)	15 (420)
DG021B-5-B	106.8 (12)	500	1.6 (0.8)	6.1" (155)	3/8" (10)	0.7" (17)	15 (420)

* No Chuck

** Keyless Chuck: 3/8" (10 mm)

Series					
20	0.25 hp	76 dBa	1/4" NPT	5/16" (8mm)	3/8"-24*

Air Production Drills

Pistol Grip

50 Series

Legendary performance with a well-deserved reputation for durability.

Features

- Stall torque: 8.4 – 348 in-lbs (1 – 39 Nm)
- Speeds: 400 – 18,000 rpm
- High-performance motor delivers increased speed and power for fast, smooth hole drilling
- Ergonomically correct handle styling and lightweight, compact size enhance operator comfort
- Responsive two-stage trigger provides optimum control when starting a hole
- Excellent power-to-weight ratio gets the job done with less fatigue

Service and Accessories

Manuals:



49999042



49999500

Accessories:

Suspension bail: 46472
Spindle accessories, see page 185
Swivel air inlet, see page 186

Kits:

Service kit: 47756



DG051B-15-B



Model	in-lbs (Nm)	rpm	lbs (kg)	in (mm)	Max. in (mm)	in (mm)	cfm (L/min)
DC TRIGGER START							
DG052B-50-B	24 (2.7)	5,000	2.3 (1.1)	6.8" (171)	3/8" (10)	0.9" (22)	25 (720)
DG052B-50-L	24 (2.7)	5,000	2.3 (1.1)	6.8" (171)	3/8" (10)**	0.9" (22)	25 (720)
DG052B-30-A	33.6 (3.8)	3,000	2.3 (1.1)	6.8" (171)	1/4" (6)	0.9" (22)	25 (720)
DG052B-30-B	33.6 (3.8)	3,000	2.3 (1.1)	6.8" (171)	3/8" (10)	0.9" (22)	25 (720)
DG052B-30-L	33.6 (3.8)	3,000	2.3 (1.1)	6.8" (171)	3/8" (10)**	0.9" (22)	25 (720)
DG052B-30-P	33.6 (3.8)	3,000	2.3 (1.1)	6.8" (171)	*	0.9" (22)	25 (720)
DG052B-25-B	39.6 (4.8)	2,500	2.3 (1.1)	6.8" (171)	3/8" (10)	0.9" (22)	25 (720)
DG052B-25-L	39.6 (4.8)	2,500	2.3 (1.1)	6.8" (171)	3/8" (10)**	0.9" (22)	25 (720)
DG052B-15-B	76.8 (8.7)	1,500	2.7 (1.2)	7.5" (189)	3/8" (10)	0.9" (22)	25 (720)
DG052B-15-L	76.8 (8.7)	1,500	2.7 (1.2)	7.5" (189)	3/8" (10)**	0.9" (22)	25 (720)
DG052B-15-P	76.8 (8.7)	1,500	2.7 (1.2)	7.5" (189)	*	0.9" (22)	25 (720)
DG052B-10-A	91.2 (10)	1,000	2.7 (1.2)	7.5" (189)	1/4" (6)	0.9" (22)	25 (720)
DG052B-10-B	91.2 (10)	1,000	2.7 (1.2)	7.5" (189)	3/8" (10)	0.9" (22)	25 (720)
DG052B-10-P	91.2 (10)	1,000	2.7 (1.2)	7.5" (189)	*	0.9" (22)	25 (720)
DG052B-6-B	168 (19)	600	2.7 (1.2)	7.5" (189)	3/8" (10)	0.9" (22)	25 (720)
DG052B-6-P	168 (19)	600	2.7 (1.2)	7.5" (189)	*	0.9" (22)	25 (720)
DG052B-4-B	276 (31)	400	2.7 (1.2)	7.5" (189)	3/8" (10)	0.9" (22)	25 (720)
DG052B-4-P	276 (31)	400	2.7 (1.2)	7.5" (189)	*	0.9" (22)	25 (720)

* No Chuck

** Keyless Chuck: 3/8" (10 mm)



(continued next page)

50 Series (continued)

							
Model	in-lbs (Nm)	rpm	lbs (kg)	in (mm)	in (mm)	in (mm)	cfm (L/min)
C TRIGGER START							
DG051B-180-A	8.4 (1.0)	18,000	2.3 (1.1)	6.8" (171)	1/4" (6)	0.9" (22)	25 (720)
DG051B-180-P	8.4 (1.0)	18,000	2.3 (1.1)	6.8" (171)	*	0.9" (22)	25 (720)
DG051B-52-A	28.8 (3.3)	5,200	2.3 (1.1)	6.8" (171)	1/4" (6)	0.9" (22)	25 (720)
DG051B-52-B	28.8 (3.3)	5,200	2.3 (1.1)	6.8" (171)	3/8" (10)	0.9" (22)	25 (720)
DG051B-52-P	28.8 (3.3)	5,200	2.3 (1.1)	6.8" (171)	*	0.9" (22)	25 (720)
DG051B-33-A	42.0 (4.7)	3,300	2.3 (1.1)	6.8" (171)	1/4" (6)	0.9" (22)	25 (720)
DG051B-33-B	42.0 (4.7)	3,300	2.3 (1.1)	6.8" (171)	3/8" (10)	0.9" (22)	25 (720)
DG051B-33-P	42.0 (4.7)	3,300	2.3 (1.1)	6.8" (171)	*	0.9" (22)	25 (720)
DG051B-27-A	49.2 (5.5)	2,700	2.3 (1.1)	6.8" (171)	1/4" (6)	0.9" (22)	25 (720)
DG051B-27-B	49.2 (5.5)	2,700	2.3 (1.1)	6.8" (171)	3/8" (10)	0.9" (22)	25 (720)
DG051B-27-P	49.2 (5.5)	2,700	2.3 (1.1)	6.8" (171)	*	0.9" (22)	25 (720)
DG051B-15-A	96 (11)	1,500	2.7 (1.2)	7.5" (189)	1/4" (6)	0.9" (22)	25 (720)
DG051B-15-B	96 (11)	1,500	2.7 (1.2)	7.5" (189)	3/8" (10)	0.9" (22)	25 (720)
DG051B-15-P	96 (11)	1,500	2.7 (1.2)	7.5" (189)	*	0.9" (22)	25 (720)
DG051B-11-A	114 (13)	1,100	2.7 (1.2)	7.5" (189)	1/4" (6)	0.9" (22)	25 (720)
DG051B-11-B	114 (13)	1,100	2.7 (1.2)	7.5" (189)	3/8" (10)	0.9" (22)	25 (720)
DG051B-11-P	114 (13)	1,100	2.7 (1.2)	7.5" (189)	*	0.9" (22)	25 (720)
DG051B-6-A	204 (23)	600	2.7 (1.2)	7.5" (189)	1/4" (6)	0.9" (22)	25 (720)
DG051B-6-B	204 (23)	600	2.7 (1.2)	7.5" (189)	3/8" (10)	0.9" (22)	25 (720)
DG051B-6-P	204 (23)	600	2.7 (1.2)	7.5" (189)	*	0.9" (22)	25 (720)
DG051B-4-A	348 (39)	400	2.7 (1.2)	7.5" (189)	1/4" (6)	0.9" (22)	25 (720)
DG051B-4-B	348 (39)	400	2.7 (1.2)	7.5" (189)	3/8" (10)	0.9" (22)	25 (720)
DG051B-4-P	348 (39)	400	2.7 (1.2)	7.5" (189)	*	0.9" (22)	25 (720)

* No Chuck

** Keyless Chuck: 3/8" (10 mm)

Series					
50	0.55 hp	78 dBa	1/4" NPT	5/16" (8mm)	3/8"-24*

Air Production Drills

Pistol Grip

5 Series

Durability and performance are the hallmarks of these proven winners.

Features

- Stall Torque: 20 – 79.7 in-lbs (2.3 – 9.0 Nm)
- Speeds: 900 – 2000 rpm
- Power: 0.40 hp
- Variable speed control allows slow starting and high speed for fast drilling
- Skinsulate housing for operator comfort and productivity
- Excellent power-to-weight ratio gets the job done with less fatigue

Service and Accessories

Manuals:



P7092

Accessories:

Piped away exhaust kit: 5L-K184
Horizontal hanger: 5RA-A365
Chuck: 6A-99
Dead handle: 728N-A48, (requires 2): 5A-49

Kits:

Tune-up kit: 5RA/5RL-TK1



5RANST8

	Max Nm	1 min.	lbs (kg)	in (mm)	Max. in (mm)	in (mm)	cfm (L/min)
Model	in-lbs (Nm)	rpm	lbs (kg)	in (mm)	in (mm)	in (mm)	cfm (L/min)
DC TRIGGER START							
5RALST6	35.4 (4.0)	2,000	2.2 (1.0)	6.2" (157)	3/8" (10)	0.8" (21)	17 (480)
5RANST8	70.8 (8.0)	900	3.0 (1.4)	8.3" (210)	1/2" (13)	0.8" (21)	17 (480)
5RANST6	70.8 (8.0)	900	3.0 (1.4)	8.3" (210)	3/8" (10)	0.8" (21)	17 (480)
C TRIGGER START							
5AHST4	20 (2.3)	5,000	2.0 (0.9)	6.8" (173)	1/4" (6)	0.8" (21)	17 (480)
5AJST4	20 (2.3)	4,500	2.0 (0.9)	6.8" (173)	1/4" (6)	0.8" (21)	17 (480)
5AKST4	30.1 (3.4)	3,000	2.0 (0.9)	6.8" (173)	1/4" (6)	0.8" (21)	17 (480)
5ALST4	39.8 (4.5)	2,200	2.0 (0.9)	6.8" (173)	1/4" (6)	0.8" (21)	17 (480)
5ANST6	79.7 (9.0)	1,000	2.8 (1.3)	8.1" (207)	3/8" (10)	0.8" (21)	17 (480)

Series				
5	0.40 hp	75 dBa	1/4" NPT	1/4" (6 mm)

6 Series

Dependability and consistency have made the 6 series drills a staple in many assembly environments.

Features

- Stall Torque: 7.1 – 316 in-lbs (0.8 – 35.7 Nm)
- Speeds: 350 – 20,000 rpm
- Power: 0.51 hp
- Skinsulate housing for operator comfort and productivity
- Cantilever-mounted planetary gears are easily accessible without need to press from gear frame; simplifies maintenance
- Excellent power-to-weight ratio gets the job done with less fatigue



6ALST4

Service and Accessories

Manuals:

- 16572828
- 16572190
- 16572604

Accessories:

- Horizontal hanger: GWS-366
- Vertical hanger: 7L-365
- Dead handle: R1A-A48, (requires 2): 6A-49
- Chuck: R00A-99

Kits:

- Tune-up kit: 6-DRILLS-TK1

Model	in-lbs (Nm)	rpm	lbs (kg)	in (mm)	in (mm)	in (mm)	cfm (L/min)
C TRIGGER START							
6ADST4	7.1 (0.8)	20,000	2.2 (1.0)	7.0" (178)	1/4" (6)	0.8" (21)	20 (560)
6AHST4	23 (2.6)	6,000	2.2 (1.0)	7.0" (178)	1/4" (6)	0.8" (21)	20 (560)
6AJST4	27 (3.1)	5,100	2.2 (1.0)	7.0" (178)	1/4" (6)	0.8" (21)	20 (560)
6AJJST4	35 (4.1)	3,950	2.2 (1.0)	7.0" (178)	1/4" (6)	0.8" (21)	20 (560)
6AKST4	45.1 (5.1)	3,100	2.2 (1.0)	7.0" (178)	1/4" (6)	0.8" (21)	20 (560)
6ALST4	64.6 (7.3)	2,150	2.2 (1.0)	7.0" (178)	1/4" (6)	0.8" (21)	20 (560)
6AMST6	89.4 (10.1)	1,500	2.8 (1.3)	8.0" (203)	3/8" (10)	0.8" (21)	20 (560)
6ARST6	222.2 (25.1)	500	3.0 (1.4)	8.3" (210)	3/8" (10)	0.8" (21)	20 (560)
6ASST6	316 (35.7)	350	3.0 (1.4)	8.3" (210)	3/8" (10)	0.8" (21)	20 (560)

Series				
6	0.51 hp	74 dBa	1/4" NPT	3/8" (10 mm)

Air Production Drills

Pistol Grip

7 Series

Durability and performance are the hallmarks of these proven winners.

Features

- Stall Torque: 10 – 270 in-lbs (1.13 – 30.5 Nm)
- Speeds: 600 – 20,000 rpm
- Power: 0.75 hp
- Skinsulate housing for operator comfort and productivity
- Cantilever-mounted planetary gears are easily accessible without need to press from gear frame; simplifies maintenance
- Excellent power-to-weight ratio gets the job done with less fatigue

Service and Accessories

Manuals:

 P7094

Accessories:







Horizontal hanger: 7RA-A366
Dead handle: R1A-48, (requires 2): 7A-49
Chuck: ROK-99



7AQST8

Kits:

Tune-up kit: 7A-DRILLS-TK1

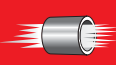
							
Model	in-lbs (Nm)	rpm	lbs (kg)	in (mm)	in (mm)	in (mm)	cfm (L/min)
TRIGGER START							
7ADST4	10 (1.1)	20,000	2.2 (1.0)	7.4" (189)	1/4" (6)	0.9" (22)	25 (700)
7AHST4	33 (3.7)	6,000	2.3 (1.1)	7.4" (189)	1/4" (6)	0.9" (22)	25 (700)
7AJST4	40 (4.5)	4,800	2.3 (1.1)	7.4" (189)	1/4" (6)	0.9" (22)	25 (700)
7AJJST4	47 (5.5)	4,000	2.3 (1.1)	7.4" (189)	1/4" (6)	0.9" (22)	25 (700)
7AKST6	58 (6.6)	3,200	2.4 (1.1)	7.6" (194)	3/8" (10)	0.9" (22)	25 (700)
7ALST6	78 (8.8)	2,400	2.7 (1.2)	7.8" (198)	3/8" (10)	0.9" (22)	25 (700)
7AMST6	130.1 (14.7)	1,400	2.9 (1.3)	8.5" (216)	3/8" (10)	0.9" (22)	25 (700)
7ANST8	185.0 (20.9)	900	3.2 (1.5)	8.7" (222)	1/2" (13)	0.9" (22)	25 (700)
7AQST8	269.9 (30.5)	600	3.2 (1.5)	8.7" (222)	1/2" (13)	0.9" (22)	25 (700)

Series				
7	0.75 hp	82 dBa	1/4" NPT	5/16" (8 mm)

7800 Series

The 7800 series drills offer enough power for your toughest applications.

Features

- Stall Torque: 48 – 654 in-lbs (5.4 – 74 Nm)
- Speeds: 350 – 4500 rpm
- Excellent for production-line drilling of large diameter holes
- Double row ball bearing construction assures max TIR of .005" for precise, concentric holes
- Side handle on 350/600 rpm models

Service and Accessories

Manuals:







 49999011

Accessories:

Spindle accessories, see page 185
Swivel air inlet, see page 186



7846-E

	 Max Nm	 1 min. rpm			Max. 		
Model	in-lbs (Nm)	rpm	lbs (kg)	in (mm)	in (mm)	in (mm)	cfm (L/min)
TRIGGER START							
7845-E	48 (5.4)	4,500	3.9 (1.8)	8.3" (210)	3/8" (10)	1.0" (25)	31 (840)
7846-E	90 (10)	2,400	3.9 (1.8)	8.3" (210)	3/8" (10)	1.0" (25)	31 (840)
7847-E	192 (22)	1,100	5.4 (2.4)	10.5" (267)	1/2" (13)	1.0" (25)	31 (840)
7848-E	354 (40)	600	5.4 (2.4)	10.5" (267)	1/2" (13)	1.0" (25)	31 (840)
7849-E	654 (74)	350	5.4 (2.4)	10.5" (267)	1/2" (13)	1.0" (25)	31 (840)

Series				
7800	0.70 hp	88 dBa	1/4" NPT	5/16" (8mm)

Air Production Drills

Pistol Grip

8500 Series

Unique Quick Reverse Touch (QRT) control trigger makes this design well-adapted to applications requiring frequent reversing.

Features

- Stall Torque: 960 – 1320 in-lbs (9.1 – 12.5 Nm)
- Speeds: 600 – 900 rpm
- Power: 0.31 hp
- High and low speed model options

Service and Accessories

Manuals:



49999032

Accessories:

Spindle accessories, see page 185
Swivel air inlet, see page 186

Kits:

Service kit: 42122-2



8506-ADB

	Max Nm	1 min.	lb (kg)	in (mm)	Max. in (mm)	in (mm)	cfm (L/min)
Model	in-lb (Nm)	rpm	lb (kg)	in (mm)	in (mm)	in (mm)	cfm (L/min)
QRT TRIGGER START							
8509-ADB	80 (9.1)	900	2.9" (1.3)	8.0" (203)	3/8" (10)	0.9" (23)	24 (678)
8509-ADK	80 (9.1)	900	2.9" (1.3)	8.0" (203)	1/2" (13)	0.9" (23)	24 (678)
8506-ADB	110 (12.5)	600	2.9" (1.3)	8.0" (203)	3/8" (10)	0.9" (23)	26 (732)
8506-ADK	110 (12.5)	600	2.9" (1.3)	8.0" (203)	1/2" (13)	0.9" (23)	26 (732)

Series	82 dBa	1/4" NPT	5/16" (8 mm)
8500	82 dBa	1/4" NPT	5/16" (8 mm)

Air Maintenance Drills

Pistol Grip

728 Series

728 Series drills are economical general purpose drills ideal for most maintenance applications.

Features

- Stall Torque: 30 – 120 in-lbs (3.4 – 13.6 Nm)
- Speeds: 950 – 3800 rpm
- Power: 0.50 hp
- Keyed and keyless chuck sizes: 5/16" – 1/2"
- Dead handle standard on 728NA3
- Economically priced for general maintenance applications

Service and Accessories

Manuals:

 P6297

Accessories:







Spindle accessories, see page 185
Swivel air inlet, see page 186

Kits:

Tune-up kit: 728-TK3

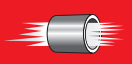

728L6K

							
Model	in-lbs (Nm)	rpm	lbs (kg)	in (mm)	in (mm)	in (mm)	cfm (L/min)
C TRIGGER START							
728JA1	30 (3.4)	3,800	2.4 (1.1)	7.0" (177)	3/8" (10)	0.9" (23)	19 (538)
728J6K	30 (3.4)	3,800	2.4 (1.1)	7.0" (177)	3/8" (10)*	0.9" (23)	19 (538)
728LA2	54 (6.1)	2,100	2.5 (1.2)	7.3" (184)	3/8" (10)	0.9" (23)	19 (538)
728L6K	54 (6.1)	2,100	2.5 (1.2)	7.3" (184)	3/8" (10)*	0.9" (23)	19 (538)
728NA3	120 (14)	950	3.1 (1.4)	8.4" (212)	1/2" (13)	0.9" (23)	19 (538)
728N8K	120 (14)	950	3.1 (1.4)	8.4" (212)	1/2" (13)*	0.9" (23)	19 (538)

*Keyless chuck.

Series			
Maintenance Drills	84 dBa	1/4" NPT	1/4" (6 mm)

Air Production Drills

Inline

Q2 Series



Compact and lightweight, Q2 drills deliver more power in a smaller package to get the job done in less time.

Features

- Stall Torque: 10.6 – 33.6 in-lbs (1.2 – 3.8 Nm)
- Speeds: 1500 – 5100 rpm
- Variable speed control allows slow starting and high speed for fast drilling
- Excellent power-to-weight ratio gets the job done with less fatigue

Service and Accessories

Manuals:

-  16572752
-  16572042
-  16576332

Accessories:







Horizontal hanger: 3RA-365
 Chuck: R0H-99
 Spindle accessories, see page 185





Kits:

Tune-up kit: Q2-PDRILL-TK1

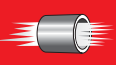

QS151D

	 Max. Nm	 1 min.			 Max.		
Model	in-lbs (Nm)	rpm	lbs (kg)	in (mm)	in (mm)	in (mm)	cfm (L/min)
C LEVER START							
QS511D	10.6 (1.2)	5,100	1.4 (0.6)	8.1" (205)	1/4" (6)	0.6" (15)	16 (450)
QS381D	13.3 (1.5)	3,800	1.4 (0.6)	8.1" (205)	1/4" (6)	0.6" (15)	16 (450)
QS301D	16.8 (1.9)	3,000	1.4 (0.6)	8.1" (205)	1/4" (6)	0.6" (15)	16 (450)
QS151D	33.6 (3.8)	1,500	1.4 (0.6)	8.1" (205)	1/4" (6)	0.6" (15)	16 (450)

Series					
Q2	0.30 hp	75 dBa	1/4" NPT	1/4" (6 mm)	3/8"-24

20 Series

20 Series drills offer impressive power-to-weight ratio in a comfortable design.

Features

- Stall Torque: 2.4 – 106.8 in-lbs (0.3 – 12.0 Nm)
- Speeds: 500 – 22,000 rpm
- High-performance motor delivers increased speed and power for fast, smooth hole drilling
- Variable-speed lever throttle provide optimum control when starting a hole
- Excellent power-to-weight ratio gets the job done with less fatigue



DL022B-26-A

Service and Accessories

Manuals:

49999065

Accessories:

Suspension bail: 46328
Spindle accessories, see page 185

Kits:

Service kit: 47755

	Max. Nm	1 min.	lbs (kg)	in (mm)	Max. in (mm)	in (mm)	cfm (L/min)
Model	in-lbs (Nm)	rpm	lbs (kg)	in (mm)	in (mm)	in (mm)	cfm (L/min)
DC LEVER START							
DL022B-26-A	14.4 (1.6)	2,600	1.0 (0.5)	7.2" (182)	1/4" (6)	0.6" (1.5)	15 (420)
DL022B-26-P	14.4 (1.6)	2,600	1.0 (0.5)	7.2" (182)	*	0.6" (1.5)	15 (420)
DL022B-15-A	25.2 (2.8)	1,500	1.1 (0.5)	7.5" (191)	1/4" (6)	0.6" (1.5)	15 (420)
DL022B-15-B	25.2 (2.8)	1,500	1.1 (0.5)	7.5" (191)	3/8" (10)	0.6" (1.5)	15 (420)
DL022B-15-P	25.2 (2.8)	1,500	1.1 (0.5)	7.5" (191)	*	0.6" (1.5)	15 (420)
DL022B-8-A	49.2 (5.5)	800	1.1 (0.5)	7.5" (191)	1/4" (6)	0.6" (1.5)	15 (420)
DL022B-8-B	49.2 (5.5)	800	1.1 (0.5)	7.5" (191)	3/8" (10)	0.6" (1.5)	15 (420)
DL022B-8-P	49.2 (5.5)	800	1.1 (0.5)	7.5" (191)	*	0.6" (1.5)	15 (420)

*No chuck.





(continued next page)

Series					
20	0.25 hp	76 dBa	1/4" NPT	5/16" (8mm)	3/8"-24*

Air Production Drills

Inline

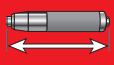
20 Series *(continued)*

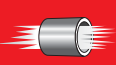
							
Model	in-lbs (Nm)	rpm	lbs (kg)	in (mm)	in (mm)	in (mm)	cfm (L/min)
C LEVER START							
DL021B-220-A	2.4 (0.3)	22,000	1.0 (0.5)	7.2" (182)	1/4" (6)	0.6" (1.5)	15 (420)
DL021B-64-A	8.4 (1.0)	6,400	1.0 (0.5)	7.2" (182)	1/4" (6)	0.6" (1.5)	15 (420)
DL021B-64-P	8.4 (1.0)	6,400	1.0 (0.5)	7.2" (182)	*	0.6" (1.5)	15 (420)
DL021B-33-A	15.6 (1.8)	3,300	1.0 (0.5)	7.2" (182)	1/4" (6)	0.6" (1.5)	15 (420)
DL021B-33-P	15.6 (1.8)	3,300	1.0 (0.5)	7.2" (182)	*	0.6" (1.5)	15 (420)
DL021B-19-A	27.6 (3.0)	1,900	1.1 (0.5)	7.5" (191)	1/4" (6)	0.6" (1.5)	15 (420)
DL021B-19-B	27.6 (3.0)	1,900	1.1 (0.5)	7.5" (191)	3/8" (10)	0.6" (1.5)	15 (420)
DL021B-19-P	27.6 (3.0)	1,900	1.1 (0.5)	7.5" (191)	*	0.6" (1.5)	15 (420)
DL021B-10-A	54 (6.0)	1,000	1.1 (0.5)	7.5" (191)	1/4" (6)	0.6" (1.5)	15 (420)
DL021B-10-B	54 (6.0)	1,000	1.1 (0.5)	7.5" (191)	3/8" (10)	0.6" (1.5)	15 (420)
DL021B-10-P	54 (6.0)	1,000	1.1 (0.5)	7.5" (191)	*	0.6" (1.5)	15 (420)
DL021B-5-A	106.8 (12)	500	1.1 (0.5)	7.5" (191)	1/4" (6)	0.6" (1.5)	15 (420)
DL021B-5-B	106.8 (12)	500	1.1 (0.5)	7.5" (191)	3/8" (10)	0.6" (1.5)	15 (420)
DL021B-5-P	106.8 (12)	500	1.1 (0.5)	7.5" (191)	*	0.6" (1.5)	15 (420)

*No chuck.

Series					
20	0.25 hp	76 dBA	1/4" NPT	5/16" (8mm)	3/8"-24*

50 Series

Legendary performance with a well-deserved reputation for durability.

Features

- Stall Torque: 8.4 – 348 in-lbs (1.0 – 39.0 Nm)
- Speeds: 400 – 18,000 rpm
- High-performance motor delivers increased speed and power for fast, smooth hole drilling
- Variable-speed lever throttle provide optimum control when starting a hole
- Excellent power-to-weight ratio gets the job done with less fatigue



DL051B-33-B

Service and Accessories

Manuals:

49999042

Accessories:

Suspension bail: 46328
Spindle accessories, see page 185

Kits:

Service kit: 47755

Model	in-lbs (Nm)	rpm	lbs (kg)	in (mm)	in (mm)	in (mm)	cfm (L/min)
DC LEVER START							
DL052B-30-A	33.6 (3.8)	3,000	2.2 (1.0)	8.6" (218)	1/4" (6)	0.9" (22)	25 (720)
DL052B-30-B	33.6 (3.8)	3,000	2.2 (1.0)	8.6" (218)	3/8" (10)	0.9" (22)	25 (720)
DL052B-30-P	33.6 (3.8)	3,000	2.2 (1.0)	8.6" (218)	*	0.9" (22)	25 (720)
DL052B-25-P	39.6 (4.8)	2,500	2.2 (1.0)	8.6" (218)	*	0.9" (22)	25 (720)
DL052B-15-B	76.8 (8.7)	1,500	2.5 (1.1)	9.3" (236)	3/8" (10)	0.9" (22)	25 (720)
DL052B-15-P	76.8 (8.7)	1,500	2.5 (1.1)	9.3" (236)	*	0.9" (22)	25 (720)
DL052B-10-B	91.2 (10)	1,000	2.5 (1.1)	9.3" (236)	3/8" (10)	0.9" (22)	25 (720)
DL052B-10-P	91.2 (10)	1,000	2.5 (1.1)	9.3" (236)	*	0.9" (22)	25 (720)
DL052B-6-B	168 (19)	600	2.5 (1.1)	9.3" (236)	3/8" (10)	0.9" (22)	25 (720)
DL052B-6-P	168 (19)	600	2.5 (1.1)	9.3" (236)	*	0.9" (22)	25 (720)
DL052B-4-B	276 (31)	400	2.5 (1.1)	9.3" (236)	3/8" (10)	0.9" (22)	25 (720)
DL052B-4-P	276 (31)	400	2.5 (1.1)	9.3" (236)	*	0.9" (22)	25 (720)

*No chuck.







(continued next page)

Series					
50	0.55 hp	78 dBa	1/4" NPT	5/16" (8mm)	3/8"-24*



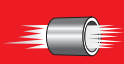

Air Production Drills

Inline

50 Series *(continued)*

							
Model	in-lbs (Nm)	rpm	lbs (kg)	in (mm)	in (mm)	in (mm)	cfm (L/min)
C LEVER START							
DL051B-180-A	8.4 (1.0)	18,000	2.2 (1.0)	8.6" (218)	1/4" (6)	0.9" (22)	25 (720)
DL051B-180-P	8.4 (1.0)	18,000	2.2 (1.0)	8.6" (218)	*	0.9" (22)	25 (720)
DL051B-52-A	28.8 (3.0)	5,200	2.2 (1.0)	8.6" (218)	1/4" (6)	0.9" (22)	25 (720)
DL051B-52-B	28.8 (3.0)	5,200	2.2 (1.0)	8.6" (218)	3/8" (10)	0.9" (22)	25 (720)
DL051B-52-P	28.8 (3.0)	5,200	2.2 (1.0)	8.6" (218)	*	0.9" (22)	25 (720)
DL051B-33-A	42 (5.0)	3,300	2.2 (1.0)	8.6" (218)	1/4" (6)	0.9" (22)	25 (720)
DL051B-33-B	42 (5.0)	3,300	2.2 (1.0)	8.6" (218)	3/8" (10)	0.9" (22)	25 (720)
DL051B-33-P	42 (5.0)	3,300	2.2 (1.0)	8.6" (218)	*	0.9" (22)	25 (720)
DL051B-27-A	49.2 (5.5)	2,700	2.2 (1.0)	8.6" (218)	1/4" (6)	0.9" (22)	25 (720)
DL051B-27-B	49.2 (5.5)	2,700	2.2 (1.0)	8.6" (218)	3/8" (10)	0.9" (22)	25 (720)
DL051B-27-P	49.2 (5.5)	2,700	2.2 (1.0)	8.6" (218)	*	0.9" (22)	25 (720)
DL051B-15-A	96 (11)	1,500	2.5 (1.1)	9.3" (236)	1/4" (6)	0.9" (22)	25 (720)
DL051B-15-B	96 (11)	1,500	2.5 (1.1)	9.3" (236)	3/8" (10)	0.9" (22)	25 (720)
DL051B-15-P	96 (11)	1,500	2.5 (1.1)	9.3" (236)	*	0.9" (22)	25 (720)
DL051B-11-B	114 (13)	1100	2.5 (1.1)	9.3" (236)	3/8" (10)	0.9" (22)	25 (720)
DL051B-11-P	114 (13)	1100	2.5 (1.1)	9.3" (236)	*	0.9" (22)	25 (720)
DL051B-6-B	204 (23)	600	2.5 (1.1)	9.3" (236)	3/8" (10)	0.9" (22)	25 (720)
DL051B-6-P	204 (23)	600	2.5 (1.1)	9.3" (236)	*	0.9" (22)	25 (720)
DL051B-4-A	348 (39)	400	2.5 (1.1)	9.3" (236)	1/4" (6)	0.9" (22)	25 (720)
DL051B-4-B	348 (39)	400	2.5 (1.1)	9.3" (236)	3/8" (10)	0.9" (22)	25 (720)
DL051B-4-P	348 (39)	400	2.5 (1.1)	9.3" (236)	*	0.9" (22)	25 (720)

*No chuck.

Series					
50	0.55 hp	78 dBa	1/4" NPT	5/16" (8mm)	3/8"-24*

5 & 6 Series

Dependability and consistency makes the 5 and 6 Series drills a staple in many assembly environments.



6LJ1

Features

- Stall Torque: 20.4 – 222.2 in-lbs (2.3 – 25.1 Nm)
- Speeds: 500 – 6,000 rpm
- Variable speed control allows slow starting and high speed for fast drilling
- Cantilever-mounted planetary gears are easily accessible without need to press from gear frame; simplifies maintenance
- Excellent power-to-weight ratio gets the job done with less fatigue

Service and Accessories

Manuals:

- 16572786 5 Series
- 16572828 6 Series

5 Series Accessories:

- Piped away exhaust kit: 5L-K184
- Horizontal hanger: 7RA-A366
- Dead handle (5LN3): 728N-A48, (requires 2): 6A-49
- Chuck: 6A-99
- Spindle accessories, see page 185

6 Series Accessories:

- Vertical hanger: 7L-365
- Dead handle: R1A-A48, (requires 2): 6A-49
- Chuck: R00A-99
- Spindle accessories, see page 185

Kits:

- Tune-up kit: 5RA-TK1 (5 Series)
- Tune-up kit: 6-DRILLS-TK1 (6 Series)

Model	in-lbs (Nm)	rpm	lbs (kg)	in (mm)	in (mm)	in (mm)	cfm (L/min)
C 5 SERIES LEVER START							
5LJ1	20.4 (2.3)	4,800	2.0 (0.9)	8.1" (205)	1/4" (6)	0.8" (20)	16 (453)
5LK1	30.1 (3.4)	3,100	2.0 (0.9)	8.1" (205)	1/4" (6)	0.8" (20)	16 (453)
5LL1	39.8 (4.5)	2,300	2.0 (0.9)	8.1" (205)	1/4" (6)	0.8" (20)	15 (425)
5LN3	79.7 (9.0)	1,000	3.3 (1.5)	9.4" (238)	3/8" (10)	0.8" (20)	15 (425)
C 6 SERIES LEVER START							
6LH1	23 (2.6)	6,000	2.1 (1.0)	7.9" (201)	1/4" (6)	0.8" (20)	20 (560)
6LJ1	27.4 (3.1)	5,100	2.1 (1.0)	7.9" (201)	1/4" (6)	0.8" (20)	20 (560)
6LJJ1	35.4 (4.0)	3,950	2.1 (1.0)	7.9" (201)	1/4" (6)	0.8" (20)	20 (560)
6LK1	45.1 (5.1)	3,100	2.1 (1.0)	7.9" (201)	1/4" (6)	0.8" (20)	20 (560)
6LL1	64.6 (7.3)	2,150	2.1 (1.0)	7.9" (201)	1/4" (6)	0.8" (20)	20 (560)
6LR3	222.2 (25.1)	500	2.9 (1.3)	9.2" (233)	3/8" (10)	0.8" (20)	20 (560)

Series				
5	0.40 hp	75 dBa	1/4" NPT	1/4" (6 mm)
6	0.51 hp	74 dBa	1/4" NPT	3/8" (10 mm)

Air Production Drills

Inline

7800 Series

The 7800 Series drills offer enough power for your toughest applications.

Features

- Stall Torque: 12 – 654 in-lbs (1.3 – 74.0 Nm)
- Speeds: 325 – 18,000 rpm
- Excellent for production-line drilling of large diameter holes
- Double row ball bearings construction assures max TIR of 0.005" for precise, concentric holes
- Side handle on 325/600 rpm models

Service and Accessories

Manuals:



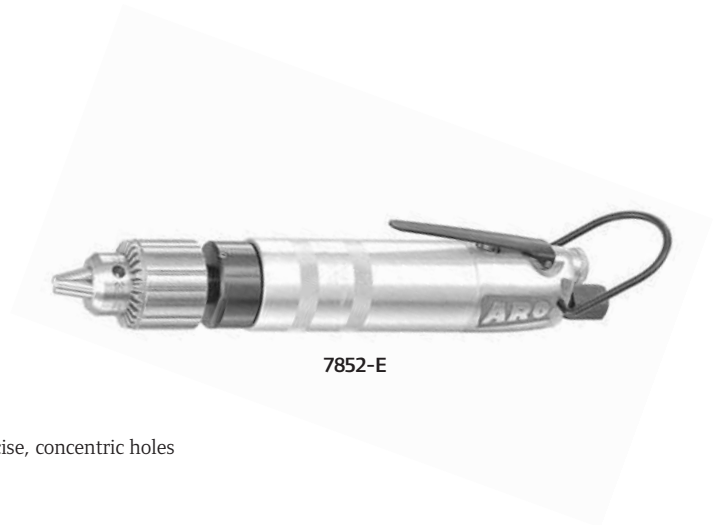

 49999011

Accessories:

Spindle accessories, see page 185

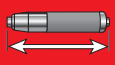

7852-E

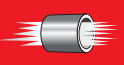
							
Model	in-lbs (Nm)	rpm	lbs (kg)	in (mm)	in (mm)	in (mm)	cfm (L/min)
C LEVER START							
7850-E	12 (1.3)	18,000	3.2 (1.5)	9.6" (244)	3/8" (10)	0.9" (24)	31 (878)
7851-E	48 (5.4)	4,500	3.2 (1.5)	9.6" (244)	3/8" (10)	0.9" (24)	31 (878)
7852-E	90 (10)	2,400	3.2 (1.5)	9.6" (244)	3/8" (10)	0.9" (24)	31 (878)
7853-E	192 (22)	1,100	4.7 (2.1)	11.8" (299)	3/8" (10)	0.9" (24)	31 (878)
7854-E	354 (40)	600	4.7 (2.1)	11.8" (299)	3/8" (10)	0.9" (24)	31 (878)
7855-E	654 (74)	325	4.7 (2.1)	11.8" (299)	3/8" (10)	0.9" (24)	31 (878)

Series					
7800	0.70 hp	88 dBa	1/4" NPT	5/16" (8mm)	1/2"-20

Air Production Drills

Angle

1 Series

1 Series drills combine proven quality and performance with economy for day in day out production drilling.

Features

- Torque Range: 120 – 168 in-lbs (1.1 – 1.6 Nm)
- Speeds: 2700 – 3,700
- Power: 0.15 hp
- Double row ball bearings construction assures max TIR of 0.005" for precise, concentric holes
- Variable speed control allows slow starting and high speed for fast drilling
- Excellent power-to-weight ratio gets the job done with less fatigue

Service and Accessories

Manuals:

 16572760

 16572661







Accessories:



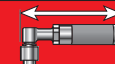

Hanger: 3RA-365

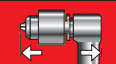
Kits:

Tune-up kit: 3A-TK2



	 Max Nm	 1 min.			 Max.			
Model	in-lbs (Nm)	rpm	lbs (kg)	in (mm)	in (mm)	in (mm)	in (mm)	cfm (L/min)
C LEVER START								
1LJ1A1	120 (1.1)	3,700	1.1 (0.5)	8.6" (219)	1/4"-28*	1.1" (28)	0.3" (8.3)	11 (311)
1LL1A1	168 (1.6)	2,700	1.1 (0.5)	8.1" (206)	1/4"-28*	1.1" (28)	0.3" (8.3)	11 (311)

Series					
1	0.15 hp	73 dBa	1/8" NPT	1/4" (6 mm)	1/4"-28 Female Thread

Air Production Drills

Angle

Q2 Series

Compact and lightweight, Q2 drills deliver more power in a smaller package to get the job done in less time.

Features

- Stall Torque: 14 – 110 in-lbs (1.6 – 12.5 Nm)
- Speeds: 500 – 3,500 rpm
- Variable speed control allows slow starting and high speed for fast drilling
- Ergonomically designed housing provides a secure surface for operator grip
- Excellent power-to-weight ratio gets the job done with less fatigue

Service and Accessories

Manuals:



16572778



16572158



16572653

Accessories:

Vertical hanger: 7L-365
Chuck: R0H-99

Kits:

Tune-up kit: Q2-PDRILL-TK1



Model	in-lbs (Nm)	rpm	lbs (kg)	in (mm)	in (mm)	in (mm)	in (mm)	cfm (L/min)
C LEVER START (90° CHUCK)								
QA2719D	19 (2.2)	2,700	2.07 (0.94)	9.35" (238)	1/4" (6)	3.0" (76)	0.54" (13.6)	16 (450)
QA2119D	24 (2.8)	2,100	2.07 (0.94)	9.35" (238)	1/4" (6)	3.0" (76)	0.54" (13.6)	16 (450)
QA1219D	43 (4.9)	1,270	2.07 (0.94)	9.35" (238)	1/4" (6)	3.0" (76)	0.54" (13.6)	16 (450)
C LEVER START (90° SMALL ANGLE HEAD)								
QA3559D	16 (1.8)	3,500	1.4 (0.6)	8.7" (221)	1/4"-28*	1.1" (27)	0.4" (10)	16 (450)
QA2739D	20 (2.3)	2,700	1.4 (0.6)	8.7" (221)	3/16"***	1.1" (27)	0.4" (10)	16 (450)
QA2759D	20 (2.3)	2,700	1.4 (0.6)	8.7" (221)	1/4"-28*	1.1" (27)	0.4" (10)	16 (450)
QA1739D	32 (3.6)	1,750	1.4 (0.6)	8.7" (221)	3/16"***	1.1" (27)	0.4" (10)	16 (450)
QA1239D	39 (4.5)	1,270	1.4 (0.6)	8.7" (221)	3/16"***	1.1" (27)	0.4" (10)	16 (450)
QA0859D	67 (7.6)	850	1.4 (0.6)	8.7" (221)	1/4"-28*	1.1" (27)	0.4" (10)	16 (450)
QA0539D	110 (12.5)	500	1.4 (0.6)	8.7" (221)	3/16"***	1.1" (27)	0.4" (10)	16 (450)
QA0579D	110 (12.5)	500	1.4 (0.6)	8.7" (221)	3/8"-24***	1.1" (27)	0.4" (10)	16 (450)
QA0559D	110 (12.5)	500	1.4 (0.6)	8.7" (221)	1/4"-28*	1.1" (27)	0.4" (10)	16 (450)
C LEVER START (45° SMALL ANGLE HEAD)								
QA2754D	17 (1.9)	2,700	1.47 (0.67)	10.55" (268)	1/4"-28*	1.3" (34)	0.3" (8.3)	16 (450)
QA0854D	57 (6.4)	850	1.47 (0.67)	10.55" (268)	1/4"-28*	1.3" (34)	0.3" (8.3)	16 (450)
C LEVER START (90° X 90° SMALL ANGLE HEAD)								
QA3555D	14 (1.6)	3,500	1.6 (0.73)	9.03" (229)	1/4"-28*	1.1" (27)	0.4" (9.3)	16 (450)
QA2755D	19 (2.1)	2,700	1.6 (0.73)	9.03" (229)	1/4"-28*	1.1" (27)	0.4" (9.3)	16 (450)

Series							
Q2	0.28 hp	75 dBa	1/4" NPT	1/4" (6 mm)	* 1/4"-28 Female Thread	** 9/32"-40 Female Thread	*** 3/8"-24 Male Thread

20 Series

20 Series drills offer impressive power-to-weight ratio in a comfortable design.

Features

- Stall Torque: 12 – 106.8 in-lbs (1.3 – 12.0 Nm)
- Speeds: 500 – 5,000 rpm
- High-performance motor delivers increased speed and power for fast, smooth hole drilling
- Complete selection of speeds and spindle options permits the proper match-up of tool to the application
- Excellent power-to-weight ratio gets the job done with less fatigue



Service and Accessories

Manuals:

49999181

Accessories:

Suspension bail: 47795
Swivel air inlets, see page 186

Kits:

Service kit: 47755

Model	in-lbs (Nm)	rpm	lbs (kg)	in (mm)	in (mm)	in (mm)	in (mm)	cfm (L/min)
LEVER START (90° CHUCK)								
DR021B-50-A	12 (1.3)	5,000	1.5 (0.7)	8.7" (221)	1/4" (6)	3.5" (89)	0.6" (15)	15 (420)
DR021B-50-P	12 (1.3)	5,000	1.5 (0.7)	8.7" (221)	***	1.6" (41)	0.6" (15)	15 (420)
DR021B-26-A	22.8 (2.6)	2,600	1.5 (0.7)	8.7" (221)	1/4" (6)	3.5" (89)	0.6" (15)	15 (420)
DR021B-26-P	22.8 (2.6)	2,600	1.5 (0.7)	8.7" (221)	***	1.6" (41)	0.6" (15)	15 (420)
DR021B-15-A	40.8 (4.6)	1,500	1.6 (0.8)	9.1" (231)	1/4" (6)	3.5" (89)	0.6" (15)	15 (420)
DR021B-15-P	40.8 (4.6)	1,500	1.6 (0.8)	9.1" (231)	***	1.6" (41)	0.6" (15)	15 (420)
DR021B-7-A	79.2 (8.9)	700	1.6 (0.8)	9.1" (231)	1/4" (6)	3.5" (89)	0.6" (15)	15 (420)
DR021B-7-P	79.2 (8.9)	700	1.6 (0.8)	9.1" (231)	***	1.6" (41)	0.6" (15)	15 (420)
LEVER START (90° SMALL ANGLE HEAD)								
DR023B-37-C	15.6 (1.8)	3,700	1.4 (0.6)	9.5" (241)	3/16" **	1.4" (36)	0.3" (8.3)	15 (420)
DR023B-37-E	15.6 (1.8)	3,700	1.4 (0.6)	9.5" (241)	5/16"-24****	1.1" (28)	0.3" (8.3)	15 (420)
DR023B-37-T	15.6 (1.8)	3,700	1.4 (0.6)	9.5" (241)	1/4"-28 *	1.1" (28)	0.3" (8.3)	15 (420)
DR023B-21-C	28.8 (3.2)	2,100	1.5 (0.7)	10" (254)	3/16" **	1.4" (36)	0.3" (8.3)	15 (420)
DR023B-21-E	28.8 (3.2)	2,100	1.5 (0.7)	10" (254)	5/16"-24****	1.1" (28)	0.3" (8.3)	15 (420)
DR023B-21-T	28.8 (3.2)	2,100	1.5 (0.7)	10" (254)	1/4"-28 *	1.1" (28)	0.3" (8.3)	15 (420)
DR023B-11-E	55.2 (6.2)	1,100	1.6 (0.7)	10" (254)	5/16"-24****	1.1" (28)	0.3" (8.3)	15 (420)
DR023B-11-T	55.2 (6.2)	1,100	1.6 (0.7)	10" (254)	1/4"-28 *	1.1" (28)	0.3" (8.3)	15 (420)
DR023B-5-C	106.8 (12)	500	1.5 (0.7)	10" (254)	3/16" **	1.4" (36)	0.3" (8.3)	15 (420)
DR023B-5-E	106.8 (12)	500	1.5 (0.7)	10" (254)	5/16"-24****	1.1" (28)	0.3" (8.3)	15 (420)
DR023B-5-T	106.8 (12)	500	1.5 (0.7)	10" (254)	1/4"-28 *	1.1" (28)	0.3" (8.3)	15 (420)

Series	Icon	Icon	Icon	Icon	Icon	Icon	Icon	
20	0.25 hp	78 dbA	1/4" NPT	5/16" (8 mm)	1/4"-28 Male Thread	9/32"-40 Male Thread	3/8"-24 Female Thread	5/16"-24 Female Thread

Air Production Drills

Angle

50 Series

Legendary performance with a well-deserved reputation for durability.

Features

- Stall Torque: 24 – 288 in-lbs (2.7 – 33 Nm)
- Speeds: 400 – 5,200 rpm
- High-performance motor delivers increased speed and power for fast, smooth hole drilling
- Complete selection of speeds and spindle options permits the proper match-up of tool to the application
- Excellent power-to-weight ratio gets the job done with less fatigue

Service and Accessories

Manuals:

 49999109

 49999303







Accessories:





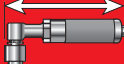

Suspension bail: 46472
Swivel air inlets, see page 186

Kits:

Service kit: 47756



Model	 in-lbs (Nm)	 rpm	 lbs (kg)	 in (mm)	 in (mm)	 in (mm)	 in (mm)	 cfm (L/min)
C LEVER START (90° CHUCK)								
DR051B-36-A	34.8 (4.0)	3,600	2.5 (1.1)	9.8" (249)	1/4" (6)	3.5" (89)	0.6" (15)	25 (720)
DR051B-36-B	34.8 (4.0)	3,600	2.5 (1.1)	9.8" (249)	3/8" (10)	3.5" (89)	0.6" (15)	25 (720)
DR051B-36-P	34.8 (4.0)	3,600	2.5 (1.1)	9.8" (249)	***	1.6" (41)	0.6" (15)	25 (720)
DR051B-28-A	44.4 (5.0)	2,800	2.5 (1.1)	9.8" (249)	1/4" (6)	3.5" (89)	0.6" (15)	25 (720)
DR051B-28-B	44.4 (5.0)	2,800	2.5 (1.1)	9.8" (249)	3/8" (10)	3.5" (89)	0.6" (15)	25 (720)
DR051B-28-P	44.4 (5.0)	2,800	2.5 (1.1)	9.8" (249)	***	1.6" (41)	0.6" (15)	25 (720)
DR051B-19-A	66 (7.5)	1,900	2.5 (1.1)	9.8" (249)	1/4" (6)	3.5" (89)	0.6" (15)	25 (720)
DR051B-19-B	66 (7.5)	1,900	2.5 (1.1)	9.8" (249)	3/8" (10)	3.5" (89)	0.6" (15)	25 (720)
DR051B-19-P	66 (7.5)	1,900	2.5 (1.1)	9.8" (249)	***	1.6" (41)	0.6" (15)	25 (720)
DR051B-11-A	117.6 (13)	1,100	2.8 (1.2)	10.4" (263)	1/4" (6)	3.5" (89)	0.6" (15)	25 (720)
DR051B-11-B	117.6 (13)	1,100	2.8 (1.2)	10.4" (263)	3/8" (10)	3.5" (89)	0.6" (15)	25 (720)
DR051B-11-P	117.6 (13)	1,100	2.8 (1.2)	10.4" (263)	***	1.6" (41)	0.6" (15)	25 (720)
DR051B-4-A	288 (33)	400	2.8 (1.2)	10.4" (263)	1/4" (6)	3.5" (89)	0.6" (15)	25 (720)
DR051B-4-B	288 (33)	400	2.8 (1.2)	10.4" (263)	3/8" (10)	3.5" (89)	0.6" (15)	25 (720)
DR051B-4-P	288 (33)	400	2.8 (1.2)	10.4" (263)	***	1.6" (41)	0.6" (15)	25 (720)
C LEVER START (90° SMALL ANGLE HEAD)								
DR053B-52-T	24.0 (2.7)	5,200	2.4 (1.1)	10.8" (274)	1/4"-28 *	1.1" (28)	0.3" (8.3)	25 (720)
DR053B-41-T	30.0 (3.4)	4,100	2.4 (1.1)	10.8" (274)	1/4"-28 *	1.1" (28)	0.3" (8.3)	25 (720)
DR053B-27-T	45.6 (5.2)	2,700	2.4 (1.1)	10.8" (274)	1/4"-28 *	1.1" (28)	0.3" (8.3)	25 (720)
C LEVER START (45° SMALL ANGLE HEAD)								
DA053B-52-T	24 (2.7)	5,200	2.4 (1.1)	11.2" (285)	1/4"-28 *	1.9" (48)	0.3" (8.3)	25 (720)
DA053B-41-T	30 (3.4)	4,100	2.4 (1.1)	11.2" (285)	1/4"-28 *	1.9" (48)	0.3" (8.3)	25 (720)
DA053B-27-T	45.6 (5.2)	2,700	2.4 (1.1)	11.2" (285)	1/4"-28 *	1.9" (48)	0.3" (8.3)	25 (720)

Series						
50	0.55 hp	78 dBa	1/4" NPT	5/16" (8 mm)	1/4"-28 Female Thread	3/8"-24 Male Thread

5 Series

Durability and performance are the hallmarks of these proven winners.

Features

- Stall Torque: 20 – 120 in-lbs (2.2 – 13.6 Nm)
- Speeds: 700 – 4800 rpm
- Power: 0.40 hp
- Small angle heads designed for close quarters drilling operations
- Excellent power-to-weight ratio gets the job done with less fatigue



5LK1B1

Service and Accessories

Manuals:

- 16572786
- 16572802

Accessories:

- Horizontal hanger: 6WS-366
- Piped away exhaust kit: 7L-K284
- Chuck: 6A-99

Kits:

- Tune-up kit: 5A/5L-TK1

Model	in-lbs (Nm)	rpm	lbs (kg)	in (mm)	in (mm)	in (mm)	in (mm)	cfm (L/min)
C LEVER START (90° CHUCK)								
5LL2A41	60.2 (6.8)	1,500	2.6 (1.2)	9.4" (239)	1/4" (6)	3.0" (75)	0.6" (15)	15 (420)
5LN2A43	120.4 (13.6)	700	3.5 (1.6)	10.2" (259)	3/8" (10)	3.6" (91)	0.6" (15)	15 (420)
C LEVER START (90° SMALL ANGLE HEAD)								
5LK1A1	31 (3.5)	3,000	2.19 (1.0)	9.8" (249)	1/4"-28 *	1.1" (28)	0.3" (8)	15 (420)
5LL1A1	40 (4.5)	2,200	2.19 (1.0)	9.8" (249)	1/4"-28 *	1.1" (28)	0.3" (8)	15 (420)
C LEVER START (45° SMALL ANGLE HEAD)								
5LH1B1	20 (2.2)	4,800	2.13 (1.0)	9.75" (248)	1/4"-28 *	-	0.3" (8)	15 (420)
5LK1B1	31 (3.5)	3,000	2.13 (1.0)	9.75" (248)	1/4"-28 *	-	0.3" (8)	15 (420)

Series					
5	0.40 hp	75 dBa	1/4" NPT	1/4" (6 mm)	1/4"-28 Female Thread

Air Production Drills

Angle

6 Series

Dependability and consistency have made the 6 Series drills a staple in many assembly environments.

Features

- Stall Torque: 23 – 320 in-lbs (2.6 – 36.2 Nm)
- Speeds: 400 – 6,000 rpm
- Power: 0.50 hp
- Small angle heads designed for close quarters drilling operations
- Excellent power-to-weight ratio gets the job done with less fatigue

Service and Accessories

Manuals:



P6784

Accessories:

Horizontal hanger: 6WS-366
Piped away exhaust kit: 7L-K284
Chuck: 6A-99



6LL2A42

Kits:

Tune-up kit: 6-DRILLS-TK1

	Max Nm	1 min.			Max.			
Model	in-lbs (Nm)	rpm	lbs (kg)	in (mm)	in (mm)	in (mm)	in (mm)	cfm (L/min)
C LEVER START (90° CHUCK)								
6LK2A41	64.6 (7.3)	2,000	2.8 (1.3)	9.5" (241)	1/4" (6)	3.0" (75)	0.5" (14)	20 (560)
6LL2A42	94.7 (10.7)	1,400	2.8 (1.3)	9.5" (242)	3/8" (10)	3.2" (81)	0.5" (14)	20 (560)
6LP3A43	192.1 (21.7)	600	3.7 (1.7)	10.6" (270)	3/8" (10)	3.9" (99)	0.7" (18)	20 (560)
6LR3A44	320.4 (36.2)	400	4.0 (1.8)	10.7" (272)	1/2" (13)	4.1" (105)	0.7" (18)	20 (560)
C LEVER START (90° SMALL ANGLE HEAD)								
6LH1A1	23 (2.6)	6,000	2.13 (0.95)	9.69" (246)	1/4"-28 *	1.1" (28)	0.3" (8)	20 (560)
6LJJ1A1	35 (4.0)	3,950	2.13 (0.95)	9.69" (246)	1/4"-28 *	1.1" (28)	0.3" (8)	20 (560)
6LK1A1	45 (5.1)	3,100	2.13 (0.95)	9.69" (246)	1/4"-28 *	1.1" (28)	0.3" (8)	20 (560)
6LL1A1	64 (7.3)	2,150	2.13 (0.95)	9.69" (246)	1/4"-28 *	1.1" (28)	0.3" (8)	20 (560)

Series					
6	0.51 hp	74 dBa	1/4" NPT	1/4" (6 mm)	* 1/4"-28 Female Thread

7 Series

Durability and performance are the hallmarks of these proven winners.

Features

- Stall Torque: 31 – 255 in-lbs (3.5 – 28.1 Nm)
- Speeds: 600 – 6,000 rpm
- Power: 0.75 hp
- Small angle heads designed for close-quarters drilling operations
- Excellent power-to-weight ratio gets the job done with less fatigue

Service and Accessories

Manuals:

-  16572794
-  16572174

Accessories:







- Horizontal hanger: 6WS-3P66
- Piped away exhaust kit: 7L-K284
- Chuck: 6A-99





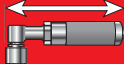

7LN3A44

Kits:

- Tune-up kit: 7L-DRILLS-TK1

								
Model	in-lbs (Nm)	rpm	lbs (kg)	in (mm)	in (mm)	in (mm)	in (mm)	cfm (L/min)
C LEVER START (90° CHUCK)								
7LJ2A41	51 (5.6)	3,250	3.0 (1.36)	10.0" (254)	1/4" (6)	2.97" (75)	0.5" (14)	26 (736)
7LL3A42	112 (12.7)	1,550	3.44 (1.56)	10.38" (263)	3/8" (10)	3.66" (93)	0.7" (18)	26 (736)
7LM3A43	170 (18.7)	900	3.9 (1.8)	11.1" (281)	3/8" (10)	3.9" (99)	0.7" (18)	26 (736)
7LN3A44	255 (28.1)	600	4.2 (1.9)	11.1" (281)	1/2" (13)	4.1" (105)	0.7" (18)	26 (736)
C LEVER START (90° SMALL ANGLE HEAD)								
7LH1A1	31 (3.5)	6,000	2.25 (1.02)	10.38" (263)	1/4"-28 *	1.1" (28)	0.3" (8)	26 (736)
7LJ1A1	40 (4.5)	4,800	2.25 (1.02)	10.38" (263)	1/4"-28 *	1.1" (28)	0.3" (8)	26 (736)
7LK1A1	57 (6.4)	3,200	2.25 (1.02)	10.38" (263)	1/4"-28 *	1.1" (28)	0.3" (8)	26 (736)

Series					
7	0.75 hp	81dBa	1/4" NPT	1/4" (6 mm)	1/4"-28 Female Thread

Air Production Drills

Flat Angle

7400 Series

The classic 7400 Series flat angle drills offer unrivaled versatility and dependability.



7439-D

Features

- Stall Torque: 48 – 99.6 in-lbs (5.4 – 11.3 Nm)
- Speeds: 1,450 – 3,300 rpm
- Excellent for drilling smaller-diameter holes for airframe builders and metal fab shops
- Flat angle head allows reach into limited access areas







Service and Accessories



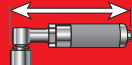

Manuals:

 49999052

Accessories:

Swivel air inlets, see page 186

Model	 in-lbs (Nm)	 rpm	 lbs (kg)	 in (mm)	 in (mm)	 in (mm)	 in (mm)	 cfm (L/min)
C LEVER START FLAT ANGLE DRILLS								
7441-D	48 (5.4)	3,300	2.9 (1.3)	10.6" (269)	1/4"-28*	0.7" (17)	0.5" (13)	24 (660)
7439-D	36 (4.1)	2,500	2.9 (1.3)	10.6" (269)	1/4"-28*	0.7" (17)	0.5" (13)	24 (660)
7438-D	99.6 (11.3)	1,450	3.5 (1.6)	11.9" (302)	1/4"-28*	0.7" (17)	0.5" (13)	24 (660)

Series				
7400	86 dBa	1/4" NPT	5/16" (8mm)	* 1/4"-28 Female Thread

43497-() One piece collets, non-precision (used with optional 43494 drive spindle)

Drill Size	Dash Number	Drill Size	Dash Number
8	-8	30	-30
11	-11	40	-40
16	-16	3/32	-163
20	-20	1/8	-165
22	-22	5/32	-167
27	-27	3/16	-169

Air Production Drills

Modular

P33 Series Motors

P33 drills with the R33 modular end effectors offer excellent power and flexibility.

Features

- Stall Torque: 16.8 – 141.6 in-lbs (1.9 – 16 Nm)
- Speeds: 660 – 5,400 rpm
- Five unique interchangeable heads that provide the ultimate in flexibility
- 0, 30, 90, and 180 degree angle heads
- Variety of bit holders
- Lube-free

Service and Accessories

Manuals:

-  80218605
-  80212798





Accessories:

5 modular attachments



P33016-PMSL

P33022-DMSL

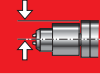
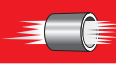
						
Model	in-lbs (Nm)	rpm	lbs (kg)	in (mm)	in (mm)	cfm (L/min)
C PISTOL GRIP / TRIGGER START						
P33054-PMSL	16.8 (1.9)	5,400	1.8 (0.8)	5.7" (146)	0.8" (21)	21 (600)
P33032-PMSL	28.3 (3.2)	3,200	1.8 (0.8)	5.7" (146)	0.8" (21)	21 (600)
P33022-PMSL	39.8 (4.5)	2,200	1.8 (0.8)	5.7" (146)	0.8" (21)	21 (600)
P33016-PMSL	60.2 (6.8)	1,600	2.0 (0.9)	6.3" (161)	0.8" (21)	21 (600)
P33011-PMSL	84.1 (9.5)	1,100	2.0 (0.9)	6.3" (161)	0.8" (21)	21 (600)
P33006-PMSL	141.6 (16)	660	2.0 (0.9)	6.3" (161)	0.8" (21)	21 (600)
C INLINE / BUTTON CONTROL						
P33054-DMSL-B	16.8 (1.9)	5,400	1.4 (0.6)	6.5" (164)	0.9" (22)	21 (600)
P33032-DMSL-B	28.3 (3.2)	3,200	1.4 (0.6)	6.5" (164)	0.9" (22)	21 (600)
C INLINE / LEVER CONTROL						
P33054-DMSL	16.8 (1.9)	5,400	1.5 (0.7)	6.5" (164)	0.9" (22)	21 (600)
P33032-DMSL	28.3 (3.2)	3,200	1.5 (0.7)	6.5" (164)	0.9" (22)	21 (600)
P33022-DMSL	39.8 (4.5)	2,200	1.5 (0.7)	6.5" (164)	0.9" (22)	21 (600)
P33016-DMSL	60.2 (6.8)	1,600	1.7 (0.8)	7.0" (179)	0.9" (22)	21 (600)
P33011-DMSL	84.1 (9.5)	1,100	1.7 (0.8)	7.0" (179)	0.9" (22)	21 (600)
P33006-DMSL	141.6 (16)	660	1.7 (0.8)	7.0" (179)	0.9" (22)	21 (600)

Series				
P33	0.44 hp	76 dBa	1/4" NPT	3/8" (10 mm)

Air Production Drills

Modular

R33 Series Attachments

P33 drills with the R33 modular end effectors offer excellent power and flexibility.

Features





- R33 Series precision drilling attachments are designed to quickly, safely, and securely connect with an assortment of pistol and inline motors in a variety of speeds
- Patented quick-change technology allows drill attachment heads to be removed and connected safely, quickly, and securely with any motors in less than three seconds
- Interchangeable heads means you only buy the components you need and configure to the application

Service and Accessories

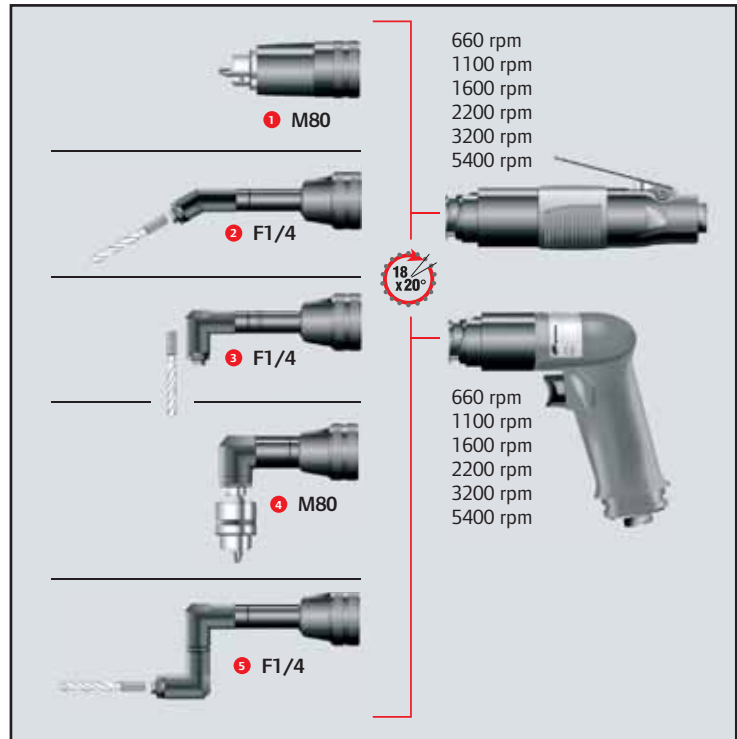
Manuals:

 MBR33001 — 021

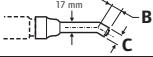
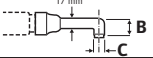
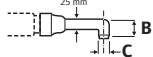
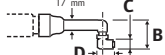

		<i>Max.</i> 		B	C	D	
	Reference	in (mm)	in (mm)	in (mm)	in (mm)	in (mm)	lbs (kg)
MODULAR DRILL ATTACHMENTS							
	① R33M000M80	0.3" (8.0)	A + 3.2" (81)	-	-	-	0.8 (0.4)
	② R33M030D17F1/4	0.3" (6.0)	A + 4.6" (118)	0.9" (24)	0.7" (18)	-	0.5 (0.2)
	③ R33M090D17F1/4	0.3" (6.0)	A + 4.1" (105)	1.4" (36)	0.7" (18)	-	0.5 (0.2)
	④ R33M090D25M80	0.3" (8.0)	A + 3.2" (81)	3.9" (99)	1.2" (30)	-	1.2 (0.5)
	⑤ R33M180D17F1/4	0.3" (6.0)	A + 4.9" (124)	2.5" (64)	0.7" (18)	1.4" (36)	0.7 (0.3)

Other Air Tools

For tapping, lightweight riveting and hammering, and electrode dressing applications, take advantage of Ingersoll Rand's line of high-quality specialty tools. For lightweight riveting applications, trust the AVC Series to get the job done. These tools offer proven performance day in and day out and come in a variety of configurations. For tapping applications, the ergonomically designed Q2 or 7 Series deliver operator comfort even in high production rates. And to minimize the downtime of your spot welding machinery, use electrode dressers to quickly recondition worn tips.



172
Air Tappers



174
Air Riveters



175
Electrode Dressers



Tappers

Pistol Grip

Q2 and 7 Series







Award-winning ergonomics coupled with proven durability and performance.

Features

- Ergonomically designed for operator comfort and high production rates
- Variable throttle for maximum control and minimum tap breakage
- Modular design makes servicing easy and economical
- Recommended for tapping applications up to 1/4" (Q2) and 1/2" (7)

Service and Accessories

Manuals:

	04577482	Q2 Series		16572810	7 Series
	45587003			16572273	
	45587011			16572612	











Accessories (Q2 Series):

Torque reaction arm: QTA010
Air tool oil: 10P
Collet: 2U-103-1/4

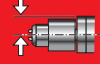
Accessories (7 Series):

Torque reaction arm: QTA040
Air tool oil: 10P
Collet: 4U-103-1/2

Model	 Max. Nm ft-lbs (Nm)	 1 min. rpm	 lb (kg)	 in (mm)	 in (mm)	 in (mm)	 cfm (L/min)
Q2 SERIES TRIGGER START							
QP1S10D8D	3.8 (5.2)	1000	1.9 (0.9)	7.2" (183)	1/4" (6)	0.6" (15)	16 (450)
QP1S05D8D	7.2 (9.8)	500	1.9 (0.9)	7.2" (183)	1/4" (6)	0.6" (15)	16 (450)
7 SERIES TRIGGER START							
7RAQT4	19.9 (27)	475	3.3 (1.5)	11.8" (300)	1/2" (13)	0.9" (22)	27 (760)

Series			
Q2	75 dBA	1/4" NPT	1/4" (6 mm)
7	79 dBA	1/4" NPT	5/16" (8 mm)

8500 and 7400 Series

Unique Quick Reverse Touch Control (QRT) trigger makes this design well-adapted to tapping applications.

8500 Series Features

- Quick reverse trigger for fast light-duty tapping applications
- High- and low-speed model options
- Recommended for tapping applications up to 5/8"

Service and Accessories

Manuals:

- 49999053 7400 Series
- 49999032 8500 Series

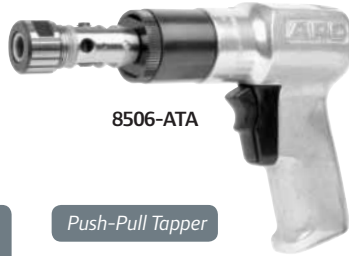

8506-ATA

Push-Pull Tapper

7400 Series Features

- Designed for thread-chasing applications in metal fab shops after painting and cleanup operations
- Standard #10 to 5/16" capacity tapping chuck
- Available with 0 to 1/4" capacity (31427) and 5/16" to 5/8" capacity (32060) tapping chucks
- Recommended for tapping applications up to 5/8"

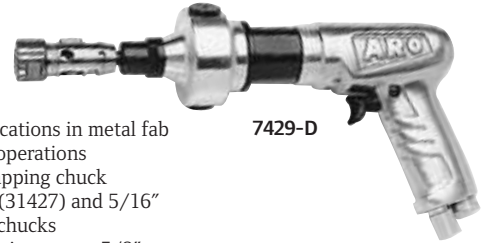

7429-D

Accessories (8500 Series):

Torque reaction arm: QTA010
Air tool oil: 10P
Collet: 31437,31436,32061

Accessories (7400 Series):

Torque reaction arm: QTA040
Air tool oil: 10P
Piped away exhaust kit: 44360-10

Model	ft-lbs (Nm)	rpm	lb (kg)	in (mm)	in (mm)	in (mm)	cfm (L/min)
8500 SERIES QRT TAPPERS							
8506-ATA	9.2 (12.5)	600	2.7 (1.2)	8.2" (208)	No. 0 - 1/4"	0.9" (23)	24 (678)
8506-ATB	9.2 (12.5)	600	2.7" (1.2)	8.2" (208)	No. 10 - 5/16"	0.9" (23)	24 (678)
8506-ATC	9.2 (12.5)	600	2.7" (1.2)	8.2" (208)	5/16" - 5/8"	0.9" (23)	24 (678)
8509-ATA	6.7 (9.1)	900	2.7" (1.2)	8.2" (208)	No. 0 - 1/4"	0.9" (23)	26 (732)
8509-ATB	6.7 (9.1)	900	2.7" (1.2)	8.2" (208)	No. 10 - 5/16"	0.9" (23)	26 (732)
8509-ATC	6.7 (9.1)	900	2.7" (1.2)	8.2" (208)	5/16" - 5/8"	0.9" (23)	26 (732)
7400 SERIES PUSH-PULL TAPPERS							
7429-D	19 (25.8)	550	3.9" (1.8)	12.0" (305.0)	5/16" (7.0)	1.3" (34)	27 (780)

Series				
8500	82 dBa	1/4" NPT	5/16" (8 mm)	3/8" -24
7400	85 dBa	1/4" NPT	5/16" (8 mm)	-

Lightweight Riveters

AVC and 772 Series

AVC Series Features



- Accurate and easily controlled lightweight riveters: handles 1/8" to 3/8" (3 to 10 mm) rivets
- Accurate and easily controlled tease throttle
- Standard beehive retainer: allows use of wide variety of accessories
- Built-in power regulators on A1 and B1 Models: the operator can change power on the job with no downtime
- Available with straight, pistol, and gooseneck handles

772 Series Features



- For light-duty cutting and hammering
- Unitized "easy-out" throttle valve assembly
- Furnished with two retainers for use with a wide variety of accessories

Service and Accessories

AVC Series Manuals:

-  16605925
-  03528742
-  16605933

















772 Series Manuals:



-  16605859
-  03525763
-  16605867

AVC Series Accessories:

- 0.401 spring retainer: AVC10-183A
- 0.401 beehive retainer: AVC1-83
- 0.498 beehive retainer: AVC24-283
- 0.401 quick change retainer: 9510
- Rivet sets, see page 184



Model	 Aluminium in (mm)	 Dural & soft iron in (mm)	 in (mm)	 lb (kg)	 in (mm)	 in (mm)	 1/min	 in	 cfm (L/min)
AVC SERIES - TRIGGER START									
AVC10A1	 1/8" (3)	1/8" (3)	6.0" (152)	2.2 (1.0)	1.9" (48)	0.6" (14)	3200	0.401"	12 (340)
AVC10C1	 1/8" (3)	1/8" (3)	6.8" (172)	2.1 (0.9)	1.9" (48)	0.6" (14)	3200	0.401"	12 (340)
AVC12A1	 3/16" (5)	3/16" (5)	7.8" (197)	3.4 (1.5)	3.0" (76)	0.6" (14)	2100	0.401"	13 (360)
AVC13A1	 1/4" (6)	1/4" (6)	8.8" (222)	3.7 (1.7)	4.0" (101)	0.6" (14)	1725	0.401"	13 (360)
AVC26A1*	 3/8" (10)	5/16" (8)	11.3" (287)	5.1 (2.3)	6.0" (152)	0.8" (19)	1120	0.498"	14 (396)
AVC26B1*	 3/8" (10)	5/16" (8)	14" (354)	7.0 (3.2)	6.0" (152)	0.8" (19)	1120	0.498"	14 (396)
772 SERIES									
772	 -	-	7.38" (187)	3.6 (1.6)	2.3" (57)	0.75" (19)	3,000	0.401"	15 (425)

Model			
AVC	95 dBA	1/4" NPT	5/16" (8 mm) 1/2" (13 mm)*
772	95 dBA	1/4" NPT	5/16" (8 mm)

Electrode Dressers

Electrode Dressers

Economical solution to dressing worn electrode tips.

Features

- Accurately dress electrodes from 5/16" to 1-1/2" diameter
- Lightweight and easy to operate
- Minimize downtime by quickly reconditioning tips on the machine
- Properly shaped electrode tips reduce energy consumption, extend electrode life, and maintain weld quality
- Lower speed models provide more dressing power at a slower material removal rate
- Recommended for reconditioning worn electrode tips

Service and Accessories

Manuals:

 49999380



 49999483





7165-B



8040-E

		Electrode Capacity Tip Diameter		
Model	rpm	in (mm)	lbs (kg)	in (mm)
7165-B	1500	5/16" - 1 1/2" (7.9 - 38)	3.5 (1.6)	10-5/8" (270)
8040-E	1000	5/16" - 1 1/2" (7.9 - 38)	4.6 (2.1)	14-1/8" (359)
8039-E	450	5/16" - 1 1/2" (7.9 - 38)	5.5 (2.5)	14-1/8" (359)
8038-E	250	5/16" - 1 1/2" (7.9 - 38)	5.5 (2.5)	14 1/8" (359)

Type			
Dressers	83 - 88 dBa	1/4" NPT	5/16" (8 mm)

Accessories

Take advantage of our extensive line of accessories to optimize your assembly operations and maximize your productivity. From Torque Reaction Arms and Torque Tubes to Spindle Accessories and Spring Balancers, we have options to complement your work cells and improve your ergonomics and efficiency. Whether a single, handheld application or a sophisticated set of custom engineered systems, we have the tools and accessories to meet your requirements and the global network of service and solutions providers capable of meeting your needs for application studies, line audits, design, project management, installation, and service.



177

Spring balancers



180

Torque Reaction Arms & Holders



182

Work Stations



183

Spindles Accessories



186

Other Accessories



Spring Balancers

Cable

BLD Series

Features

- Self-lubricating bushings
- Adjustable capacity and stroke limiting device
- Auxiliary safety suspension

Manuals:



BLD1

Model	SWL lbs (kg)	ft (m)	lbs (kg)
BLD SERIES			
BLD1	0.9 – 2.2 (0.4 – 1.0)	5.2 (1.6)	1.3 (0.6)
BLD2	2.2 – 4.4 (1.0 – 2.0)	5.2 (1.6)	1.3 (0.6)
BLD3	4.4 – 6.6 (2.0 – 3.0)	5.2 (1.6)	1.5 (0.7)

BMD Series

Features

- Safety device prevents dropping of load due to spring breakage (except on BMDS-2)
- Anti-friction cable guide
- Adjustable stroke-limiting device

Manuals:



BMDS-2

Model	SWL lbs (kg)	ft (m)	lbs (kg)
BMD SERIES			
BMDS-2	2.2 – 5.5 (1.0 – 2.5)	6.5 (2.0)	4.4 (2.0)
BMDS-4	4.4 – 8.8 (2.0 – 4.0)	6.5 (2.0)	4.4 (2.0)
BMDL-4	4.4 – 8.8 (2.0 – 4.0)	8.2 (2.5)	6.4 (2.9)
BMDS-6	8.8 – 13.2 (4.0 – 6.0)	6.5 (2.0)	5.1 (2.3)
BMDL-6	8.8 – 13.2 (4.0 – 6.0)	8.2 (2.5)	7.1 (3.2)
BMDS-8	13.2 – 17.6 (6.0 – 8.0)	6.5 (2.0)	5.5 (2.5)
BMDL-8	13.2 – 17.6 (6.0 – 8.0)	8.2 (2.5)	7.7 (3.5)
BMDL-10	17.6 – 22.0 (8.0 – 10.0)	8.2 (2.5)	8.2 (3.7)
BMDL-12	22.0 – 26.5 (10.0 – 12.0)	8.2 (2.5)	8.8 (4.0)
BMDLL-4 ⁽¹⁾	4.4 – 8.8 (2.0 – 4.0)	8.2 (2.5)	6.6 (3.0)
BMDLL-6 ⁽¹⁾	8.8 – 13.2 (4.0 – 6.0)	8.2 (2.5)	7.3 (3.3)
BMDLL-8 ⁽¹⁾	13.2 – 17.6 (6.0 – 8.0)	8.2 (2.5)	7.9 (3.6)
BMDLL-10 ⁽¹⁾	17.6 – 22.0 (8.0 – 10.0)	8.2 (2.5)	8.4 (3.8)

⁽¹⁾ Locking type balancer.

Spring Balancers

Cable

BIDS Series

Features

- Safety device prevents dropping of load due to spring breakage
- Anti-friction cable guide
- Adjustable stroke limiting device
- Upper rotary suspension
- Safety hook
- Auxiliary safety suspension



Manuals:



BIDS



BIDS-14

Model	SWL 		
	lbs (kg)	ft (m)	lbs (kg)
BIDS SERIES			
BIDS-7	8.8 – 15.4 (4.0 – 7.0)	6.5 (2.0)	5.0 (2.26)
BIDS-10	15.4 – 22.0 (7.0 – 10.0)	6.5 (2.0)	5.5 (2.49)
BIDS-14	22.0 – 30.9 (10.0 – 14.0)	6.5 (2.0)	5.5 (2.49)
BIDS-18	30.9 – 39.7 (14.0 – 18.0)	6.5 (2.0)	6.5 (2.95)
BIDS-22	39.7 – 48.5 (18.0 – 22.0)	6.5 (2.0)	6.5 (2.95)
BIDS-26	48.5 – 55.1 (22.0 – 25.0)	6.5 (2.0)	6.5 (2.95)

BHD Series

Features

- Safety device prevents dropping of load due to spring breakage
- Anti-friction cable guide
- Adjustable stroke limiting device
- Upper suspension with rotary hook
- Precision guided cable winding prevents jams
- Manual locking device for instant clamping or release
- Worm screw capacity adjustment

Manuals:





BHD

Accessories:

Floor-controlled locking device: BIL-7343



BHD-25

Model	SWL 		
	lbs (kg)	ft (m)	lbs (kg)
BHD SERIES			
BHD-15	22.0 – 33.1 (10.0 – 15.0)	6.5 (2.0)	22.7 (10.3)
BHD-20	33.1 – 44.1 (15.0 – 20.0)	6.5 (2.0)	23.4 (10.6)
BHD-25	44.1 – 55.1 (20.0 – 25.0)	6.5 (2.0)	24.7 (11.2)
BHD-30	55.1 – 66.1 (25.0 – 30.0)	6.5 (2.0)	25.4 (11.5)
BHD-35	66.1 – 77.2 (30.0 – 35.0)	6.5 (2.0)	26.0 (11.8)
BHD-45	77.2 – 99.2 (35.0 – 45.0)	6.5 (2.0)	27.3 (12.4)
BHD-55	99.2 – 121.3 (45.0 – 55.0)	6.5 (2.0)	27.6 (12.5)
BHD-65	121.3 – 143.3 (55.0 – 65.0)	6.5 (2.0)	30.0 (13.6)

BSD Series

Features

- Safety device prevents load dropping
- Upper suspension with rotary safety hook
- Anti-friction cable guide
- Precision-guided cable winding prevents jams
- Worm screw capacity adjustment
- Cable visible for inspection
- Cable replacement without balancer disassembly

Manuals:



BSD



Model	SWL	ft (m)	lbs (kg)
	lbs (kg)		
BSD SERIES			
BSD-20	33.1 – 44.1 (15.0 – 20.0)	8.2 (2.5)	41.9 (19.0)
BSDL-20	33.1 – 44.1 (15.0 – 20.0)	9.85 (3.0)	42.1 (19.1)
BSDL-25	44.1 – 55.1 (20.0 – 25.0)	9.85 (3.0)	43.9 (19.9)
BSD-30	44.1 – 66.1 (20.0 – 30.0)	8.2 (2.5)	43.7 (19.8)
BSDL-35	55.1 – 77.2 (25.0 – 35.0)	9.85 (3.0)	46.1 (20.9)
BSD-40	66.1 – 88.2 (30.0 – 40.0)	8.2 (2.5)	45.9 (20.8)
BSDL-45	77.2 – 99.2 (35.0 – 45.0)	9.85 (3.0)	52.5 (23.8)
BSD-50	88.2 – 110.2 (40.0 – 50.0)	8.2 (2.5)	52.7 (23.9)
BSDL-50	88.2 – 110.2 (40.0 – 50.0)	9.85 (3.0)	52.7 (23.9)
BSD-60	110.2 – 132.3 (50.0 – 60.0)	8.2 (2.5)	56.0 (25.4)
BSDL-60	110.2 – 132.3 (50.0 – 60.0)	9.85 (3.0)	55.8 (25.3)
BSD-70	132.3 – 154.3 (60.0 – 70.0)	8.2 (2.5)	59.1 (26.8)
BSDL-70	132.3 – 154.3 (60.0 – 70.0)	9.85 (3.0)	58.9 (26.7)
BSD-80	154.3 – 176.4 (70.0 – 80.0)	8.2 (2.5)	61.3 (27.8)

Model	SWL	ft (m)	lbs (kg)
	lbs (kg)		
BSD SERIES (CONTINUED)			
BSDL-80	154.3 – 176.4 (70.0 – 80.0)	9.85 (3.0)	61.7 (28.0)
BSD-90	176.4 – 198.4 (80.0 – 90.0)	8.2 (2.5)	63.5 (28.8)
BSDL-90	176.4 – 198.4 (80.0 – 90.0)	9.85 (3.0)	63.9 (29.0)
BSD-100	198.4 – 220.5 (90.0 – 100.0)	8.2 (2.5)	78.5 (35.6)
BSDL-100	198.4 – 220.5 (90.0 – 100.0)	9.85 (3.0)	81.1 (36.8)
BSDL-115	242.5 – 253.5 (110.0 – 115.0)	9.85 (3.0)	85.3 (38.7)
BSD-120	220.5 – 264.6 (100.0 – 120.0)	8.2 (2.5)	85.3 (38.7)
BSDL-130	253.5 – 286.6 (115.0 – 130.0)	9.85 (3.0)	88.0 (39.9)
BSD-140	264.6 – 308.6 (120.0 – 140.0)	8.2 (2.5)	92.2 (41.8)
BSDL-140	286.6 – 308.6 (130.0 – 140.0)	9.85 (3.0)	94.4 (42.8)
BSD-150	286.6 – 330.7 (130.0 – 150.0)	8.2 (2.5)	98.1 (44.5)
BSDL-150	308.6 – 330.7 (140.0 – 150.0)	9.85 (3.0)	100.5 (45.6)
BSD-165	330.7 – 363.8 (150.0 – 165.0)	8.2 (2.5)	106.3 (48.2)

Torque Reaction Arms

Bench & Floor Mounted

QTA Series

Reaction arms that set the standard for ergonomics, ease of use, and durability.

Features

- Torque capacity range from 10 – 475 Nm (7.4 – 350 ft-lbs)
- Arms up to model QTA150 utilize an Ingersoll Rand die-cast aluminum spring balancer to aid up/down movement
- Floor mounted models QTA270 and QTA475 use Ingersoll Rand air cylinders and regulator to assist in up/down travel
- QTA150 arm can be adjusted to mount to either a bench or the floor
- Anodized aluminum on bench-mounted arms delivers toughness in a lightweight design
- Simple, proven architecture makes for trouble-free set-up and use
- Arms up to QTA100 include a standard inline tool holder
- Cable/air line clips keep work area organized

Service and Accessories

Manuals:

-  45546959
-  45546942
-  45546967

Accessories:

- QTA tool holders
- Upper pole clamp and inverse mounting kit available for bench-only models



Model	Torque Capacity Nm (ft-lbs)	Weight Capacity lbs (kg)	Max. Working Reach in (mm)	Approx. Vertical Travel in (mm)	Overall Height in (mm)	Mounting Style	Movement Style
QTA010	10 (7.4)	2.64 (1.20)	15" (381)	13.0" (330)	27.8" (706)	Bench	Spring bal
QTA020	20 (14.8)	5.00 (2.27)	20" (508)	14.5" (368)	31.8" (808)	Bench	Spring bal
QTA040	40 (29.5)	6.50 (2.95)	25" (635)	17.5" (445)	39.7" (1008)	Bench	Spring bal
QTA100	100 (73.8)	8.00 (3.63)	30" (762)	17.5" (445)	39.7" (1008)	Bench	Spring bal
QTA150	150 (110.6)	10.00 (4.54)	52" (1321)	22.0" (559)	78.7" (2000)	Bench/Floor	Spring bal
QTA270	270 (199)	22.00 (10.0)	60" (1524)	18.8" (477)	78.7" (2000)	Floor	Air cylinders
QTA475	475 (350)	50.60 (23.0)	79" (2007)	23.2" (590)	78.7" (2000)	Floor	Air cylinders

Bench Mounted Arm Accessories

Model	QTA010	QTA020	QTA040	QTA100
Inverse Mounting Kit	IMK010	IMK020	IMK100	IMK100
Upper Pole Clamp	PUC010	PUC020	PUC100	PUC100

Tool Holders

QA/QE Series & Generic Styles

Holders for QTA Torque Arms

Select from a wide variety of options to ensure that the tool is correctly and safely secured to the torque arm.

Features

- Generic holders clamp to the Ingersoll Rand tools or a competitive model
- Threaded tool holder (1/4" NPT) for low-torque air tools
- For Ingersoll Rand QA & QE Series tools, please refer to the chart below to select the proper holder
- QA/QE specific holders can be mounted horizontally or vertically based on your application needs

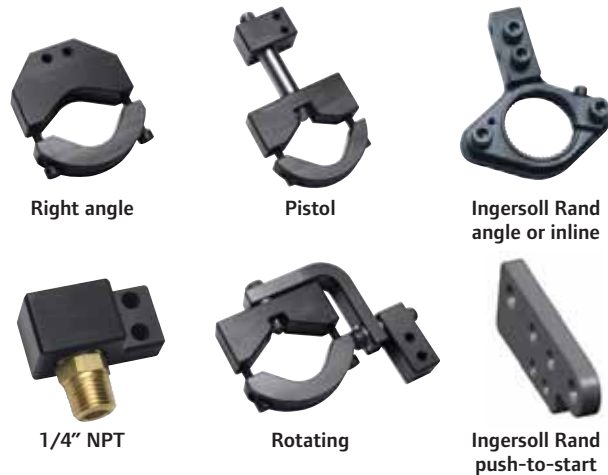

TOOL HOLDER	TORQUE ARMS			
	QTA010	QTA020	QTA040	QTA100
GENERIC CLAMP STYLE TOOL HOLDERS				
Inline (included with arm)	ITC010-1C	ITC040-1C	ITC040-1C	ITC100-1C
Right angle	ATC010-1C	ATC040-1C	ATC040-1C	ATC100-1C
Pistol	PTC010-1C	PTC040-1C	PTC040-1C	N/A
Rotating	RTC010-1C	RTC040-1C	RTC040-1C	N/A
1/4" NPT	NTC010-1T	N/A	N/A	N/A

Generic Tool holders are not available for arms 150 Nm and above

Flange mounting is recommended for inline tools with torque capacity above 40 Nm

Please note the tool diameter range for generic holders:

QTA010: 25 – 40 mm (1" – 1.57")
 QTA020 / QTA040 / QTA100:
 28 – 52 mm (1.1" – 2")

TOOLS	TORQUE ARMS						
	QTA010	QTA020	QTA040	QTA100	QTA150	QTA270	QTA475
INGERSOLL RAND QA SERIES AND QE SERIES TOOL HOLDERS							
QE4 (non-push to start)	N/A	CTC040-K1B	CTC040-K1B	N/A	N/A	N/A	N/A
QE4 (push to start)	CTC040-K1P	CTC040-K1P	CTC040-K1P	N/A	N/A	N/A	N/A
QE6	N/A	CTC040-K2B	CTC040-K2B	CTC100-K2B	N/A	N/A	N/A
QE8 (using bolt-on flange GEM120-K48)	N/A	N/A	N/A	CTC100-K2B	CTC150-K2B	N/A	N/A
QE8 (using integrated flanged gearcase)	N/A	N/A	N/A	CTC100-K3B	CTC150-K3B	CTC270-K3B	N/A
QE8 (230 Nm inline)	N/A	N/A	N/A	N/A	N/A	CTC270-K4B	N/A
QE8 (400 Nm angle)	N/A	N/A	N/A	N/A	N/A	N/A	CTC475-K5B
QA4 (angle)	N/A	CTC040-K6B	CTC040-K6B	CTC100-K6B	N/A	N/A	N/A
QA4 (27 Nm max inline) & QA6	N/A	CTC040-K1B	CTC040-K1B	CTC100-K1B	N/A	N/A	N/A
QA4 (46 Nm inline)	N/A	N/A	N/A	CTC100-K2B	N/A	N/A	N/A
QA8 (150 Nm max angle, 55 Nm max inline)	N/A	N/A	CTC040-K1B	CTC100-K1B	CTC150-K2B	N/A	N/A
QA8 (above 150 Nm angle, above 55 Nm inline)	N/A	N/A	N/A	CTC100-K2B	CTC150-K3B	CTC270-K3B	N/A

Note: Every Ingersoll Rand QE- or QA-specific tool holder listed in the table above accepts both angle and inline tools but requires an integrated flanged gear case or bolt-on mounting flange to attach the tool holder to the tool. If your tool came with mounting style "P," "R," or "J," order Part No. 15E4-K48 for any Ingersoll Rand-specific tool holder that ends with "1B." Order Part No. GEM120-K48 for any Ingersoll Rand-specific tool holder that ends with "2B." Order Part No. QA4-K48 for any Ingersoll Rand-specific tool holder that ends with "6B."

Workstations & Torque Tubes

Light-Duty Workstations





These steel-constructed, lightweight workstations offer the operator flexibility while supporting the tool weight. Add a torque absorber rod to help relieve minor torque reaction.

Part Number	Description
IRBS3-E0	Basic station (no absorber)
IRBS3-N30	Air tool station with torque absorber
IRBS3-E30	Electric tool station with torque absorber

Note: Workstations do not include tool, spring balancer, air hose, or FRL. All must be purchased separately.



Torque Tubes

Model	Description	 ft-lbs (Nm)	 lbs (kg)	 lbs (kg)	 in (mm)
54044227	IRZ-TT-100	74 (100)	60 (27)	40 (18)	20" (508)
54041819	IRZ-TT-250	184 (250)	60 (27)	50 (23)	24" (610)
54044417	IRZ-TT-500*	368 (500)	400 (182)	75 (34)	36" (914)

* Requires carriage mount.
See form # MHD55226 for more details.

Spindle Accessories

Allen Bits



Part Number	Size
1" STANDARD	
1/8DBAL-E	1/8"
9/64DBAL-E	9/64"
5/32DBAL-E	5/32"
3/16DBAL-E	3/16"
1/4dbal-E	1/4"
2" POWER MAGNETIC	
1/16HXAL-E	1/16"
5/64HXAL-E	5/64"
3/32HXAL-E	3/32"
7/64HXAL-E	7/64"
1/8HXAL-E	1/8"
9/64HXAL-E	9/64"
5/32HXAL-E	5/32"
3/16HXAL-E	3/16"
7/32HXAL-E	7/32"
1/4HXAL-E	1/4"
2" METRIC POWER MAGNETIC	
1.5HXAL-M	1.5 mm
2HXAL-M	2 mm
2.5HXAL-M	2.5 mm
3HXAL-M	3 mm
4HXAL-M	4 mm
5HXAL-M	5 mm
HXAL-M	6 mm
7HXAL-M	7 mm
8HXAL-M	8 mm

Slotted Bits



Part Number	Size
1" STANDARD	
T10DBTXR	T10
T15DBTXR	T15
T20DBTXR	T20
T25DBTXR	T25
2" POWER BITS	
6HXSL	6
8HXSL	8
10HXSL	10



Magnetic Nutsetters

2" power bits

Part Number	Size
STANDARD	
5/32HXNS-E	5/32"
3/16HXNS-E	3/16"
7/32HXNS-E	7/32"
1/4HXNS-E	1/4"
9/32HXNS-E	9/32"
5/16HXNS-E	5/16"
11/32HXNS-E	11/32"
3/8HXNS-E	3/8"
7/16HXNS-E	7/16"
1/2HXNS-E	1/2"
METRIC	
5.5HXNS-M	5.5 mm
6HXNS-M	6 mm
7HXNS-M	7 mm
8HXNS-M	8 mm
9HXNS-M	9 mm
10HXNS-M	10 mm
11HXNS-M	11 mm
12HXNS-M	12 mm
13hxns-M	13 mm

Phillips Bits



Part Number	Size
1" STANDARD	
1DBPH	1
2DBPH	2
2" POWER BITS	
1HXPH	1
2HXPH	2
3HXPH	3
3" POWER BITS	
2HXPH3L	2

Torx Bits



Tamper-resistant TB and greater

Part Number	Size
1" STANDARD	
6DBSL	6
8DBSL	8
2" POWER BITS	
T5HXTX	T5
T6HXTX	T6
T7HXTXR	T7
T8HXTXR	T8
T9HXTXR	T9
T10HXTXR	T10
T15HXTXR	T15
T20HXTXR	T20
T25HXTXR	T25
T30HXTXR	T30
T40HXTXR	T40

Spindle Accessories

Rivet Sets

Part Number	Ø A in (mm)	Ø B in (mm)	L in (mm)	Style
AV1-22C-6	0.401" (10.2)	-	3.94" (100)	5 mm brazier head
AV1-22H-6	0.401" (10.2)	-	3.94" (100)	5 mm universal head
AV1-22B-8	0.401" (10.2)	-	3.94" (100)	6 mm round head
AV1-22B-10	0.401" (10.2)	-	3.94" (100)	8 mm round head
AV1-126D	0.401" (10.2)	0.98" (25)	3.62" (92)	Flush head
AV24-126D	0.498" (12.7)	0.98" (25)	3.23" (82)	Flush head
AV1-22S-16	0.401" (10.2)	0.51" (13)	3.98" (101)	Soft blank 1
AV1-22S-20	0.401" (10.2)	0.63" (16)	3.98" (101)	Soft blank 1
AV1-22S-24	0.401" (10.2)	0.75" (19)	3.98" (101)	Soft blank 1
AV1-22S-28	0.401" (10.2)	0.87" (22)	3.98" (101)	Soft blank 1
AV24-222S-26	0.498" (12.7)	0.83" (21)	3.23" (82)	Soft blank 2
AV24-222S-38	0.498" (12.7)	1.18" (30)	3.23" (82)	Soft blank 2

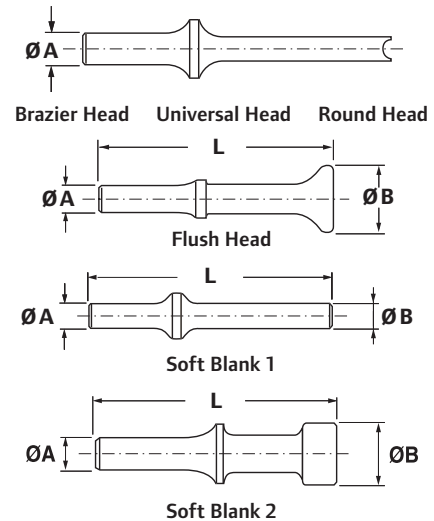

Drive Guides and Magnetic Bit Holders



Part Number	Size
3HXDRGD	3" drive guide
2HXMGBH	2" bit holder
3HXMGBH	3" bit holder



Hex to Square Adapters

Part Number	Size
1/4HXSQAD	1/4" sq
3/8HXSQAD	3/8" sq

Power Screwdriver Adapters

Part Number	Bit Size	Square Drive
2U-812	5/16" square	3/8"
4U-812	5/16" square	1/2"
POWER SQUARE INSERT BIT FOR POWER ADAPTERS		
SPB082-5	Phillips bit	2
SPB083-5	Phillips bit	3
SPB084-5	Phillips bit	4

Power Universal Joints

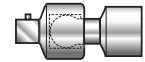

Input Drive (Square)	Output Drive (Square)	Part Number
3/8"	3/8"	J3
1/2"	1/2"	J4
3/4"	3/4"	J6

Power Socket Adapters



Drive Size Female	Male	Part Number
1/4"	3/8"	A2F3M
3/8"	1/4"	A3F2M
3/8"	1/2"	A3F4M
1/2"	3/8"	A4F3M

Power Driver Extensions



Drive (Square)	Length	Part Number
3/8"	3	E33H
3/8"	6	E36H
1/2"	3	E43H
1/2"	5	E45H
3/4"	3	E63H

Please see the Sockets brochure, form # IR-0506-016, for complete line of impact sockets.

Drill Adapters

Part Number	Thread Size	Drive
SQUARE DRIVE ADAPTER		
R0H-P212-3/8	3/8"-24 female thread	3/8"
QUICK CHANGE ADAPTERS		
R0H-A925-4	3/8" - 24	1/4"
Part Number	Drive Spindle	Female Thread
SPINDLE ADAPTERS		
30629	1/2"-20 (male)	3/8"-24
30384-5	3/8" square	3/8"-24
30384-9	1/2" square	3/8"-24
40768	1/2" square	1/2"-20



General Chucks

Part Number	Chuck Size	Thread Size	Key
DRILL CHUCKS			
7802-99	3/8"	3/8" - 24	N/A
30016	3/8"	1/2" - 20	N/A
7803-99	1/2"	3/8" - 24	R1T-J253
R1N-99A	1/2"	1/2" - 20	N/
36953	1/4"	No. 1 taper	N/A
33906	1/4"	1/2" - 20	N/A
KEYLESS CHUCKS			
728-99-KC5	3/8"	3/8" - 24	N/A
728-99-KC8	1/2"	3/8" - 24	N/A
STANDARD DUTY CHUCKS			
7801-99-6	3/8"	3/8" - 24	728N-253
7806-99-8	1/2"	3/8" - 24	728N-253
MEDIUM DUTY CHUCKS			
R0H-99	1/4"	3/8" - 24	R1H-J253
HEAVY DUTY CHUCKS			
6A-99	3/8"	3/8" - 24	R0J-J253
R00A-99	1/4"	3/8" - 24	R00A-J253
R0K-99	5/64" - 1/2"	3/8" - 24	R1T-J253



Power Quick Change Chucks

Square Drive Female	Hex Chuck Size Female	Part Number
3/8"	1/4"	2U-A925-4
3/8"	7/16"	502-A925-7
1/2"	7/16"	4U-A925-7

Other Accessories

Ergo Grips / Bio Grips / Comfort Grips

Part Number	Used With:
ERGO GRIPS	
SEG3A-IR	Series 1
SEG4-IR	Series 41 (1700 rpm or less)
SEG4H-IR	Series 41 (over 1700 rpm)
REPLACEMENT FOAM GRIP KITS	
SEG3A-CGK	For SEG3 models
SEG4-CGK	For SEG4 models
BIO BRACE	
SBB4-AR41	Series 41 (1700 rpm or less)
SBB4-VS	VersaTec
COMFORT GRIPS	
CG-6X8	6" x 8" sheet with tape
CG-ST42	42" roll of seam tape

Lubricants

Part Number	Description
CLASS 1 #10 OILS FOR AIR TOOLS	
10Z4	4 oz oil
10P	1 pt oil
10G	1 gal oil
10G55	55 gal oil
GREASE	
23-1 LB	#23 - 1 lb - drill gearing
28 1 LB	#28 - 1 lb - SD gearing and clutches
28 8 LB	#28 - 8 lb - SD gearing and clutches
66 1 LB	#66 - 1 lb - slow-speed angle heads
66 8 LB	#66 - 8 lb - slow-speed angle heads
67-4T	#67 - 4 oz tube - high-speed angle heads
GTH-1	grease gun for 4 oz tube
67-1 LB	#67 - 1 lb - high-speed angle heads
67 8 LB	#67 - 8 lb - high-speed angle heads
68-1LB	#68 - 1 lb - Coupling splines



Work Gloves

Part Number	Description
IR-GL-1	Standard black, large
IR-GXL-1	Standard black, extra large
TGSL-GL-1	Thunder gun series, large
TGSL-GXL-1	Thunder gun series, extra large
TNT-GL-1	Titanium series, large
TNT-GXL-1	Titanium series, extra large

360° Swivel Air Inlets

Part Number	Inlet	CFM	Type
ASA-1/4	0-25	1/4"	Adjustable
ASC-1/4	0-33	1/4"	Non-marring
AS-3/8	0-45	3/8"	Standard
AS-1/2	0-65	1/2"	Standard

Angle Head Boots

25 mm	28 mm	35 mm	43 mm	48 mm	56 mm
131996	131995	131997	GEA40-172	GEA40-173	GEA240-173

Based on tool angle head diameter

Polyurethane Coil Hoses

Part Number	Description
P14-10	1/4" x 10' polyurethane coil hose, (1) 1/4" rigid, (1) 1/4" swivel fitting
P14-20	1/4" x 20' polyurethane coil hose, (1) 1/4" rigid, (1) 1/4" swivel fitting
P14-30	1/4" x 30' polyurethane coil hose, (1) 1/4" rigid, (1) 1/4" swivel fitting
P38-10	3/8" x 10' polyurethane coil hose, (1) 3/8" rigid, (1) 3/8" swivel fitting
P38-20	3/8" x 20' polyurethane coil hose, (1) 3/8" rigid, (1) 3/8" swivel fitting
P38-30	3/8" x 30' polyurethane coil hose, (1) 3/8" rigid, (1) 3/8" swivel fitting
P12-10R	1/2" x 10' polyurethane coil hose, (2) 1/2" reusable swivel fittings
P12-20R	1/2" x 20' polyurethane coil hose, (2) 1/2" reusable swivel fittings
P12-30R	1/2" x 30' polyurethane coil hose, (2) 1/2" reusable swivel fittings

Model Identification Guide

Versatec Electric Screwdrivers

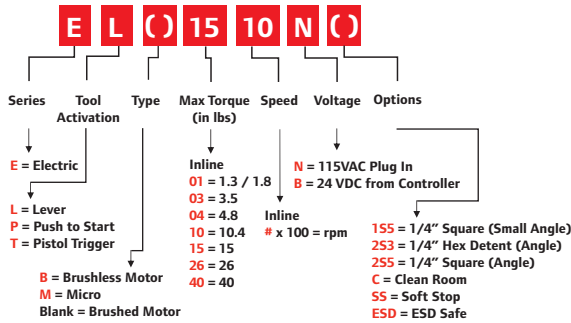

QE Series DC Electric Nutrunners

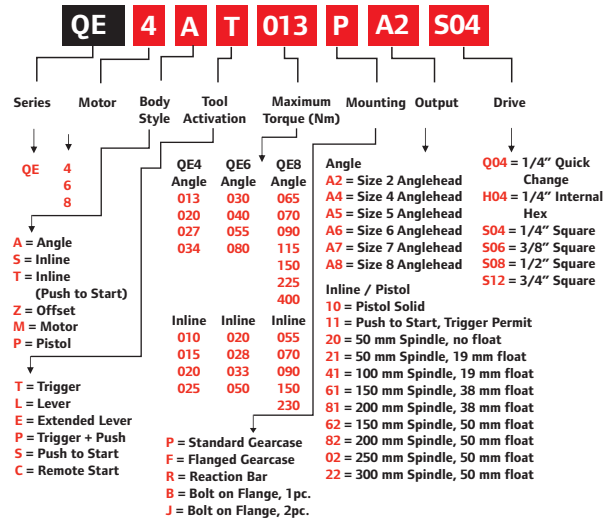

QM Series DC Electric Spindles

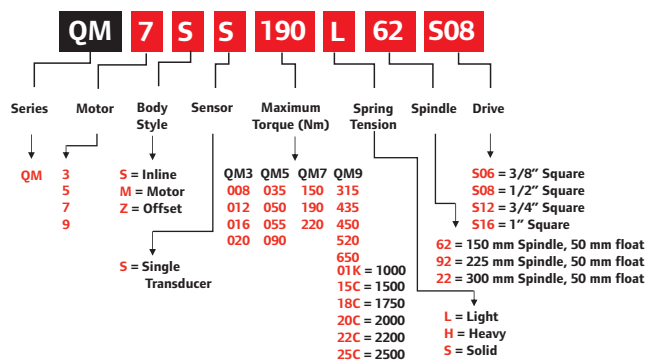

IC Series DC Electric Controllers

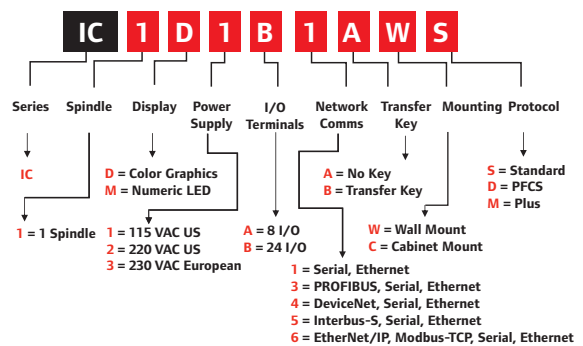

Model Identification Guide

Fixtured Fastening Handles

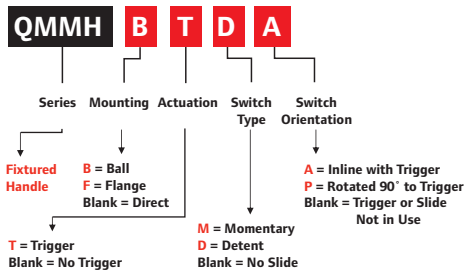

1 Series Air Screwdrivers / Nutrunners

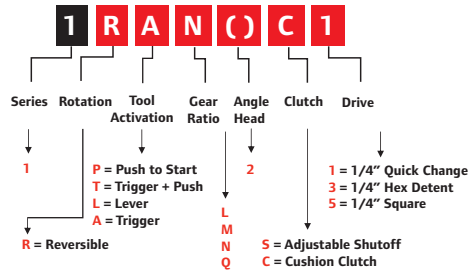

Q2 Series Air Screwdrivers / Nutrunners

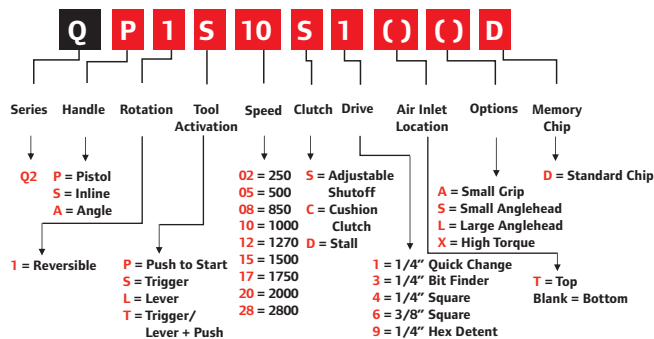

20 & 50 Series Air Screwdrivers

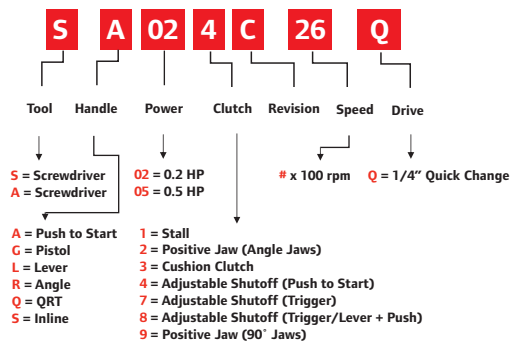

41 Series Air Screwdrivers / Nutrunners

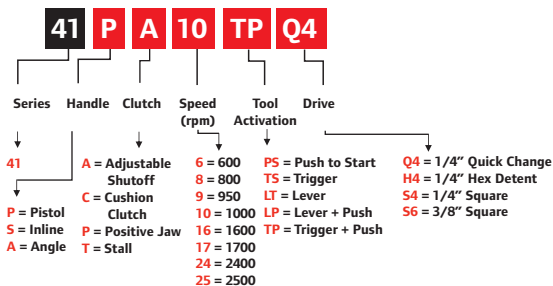

5 & 7 Series Air Screwdrivers

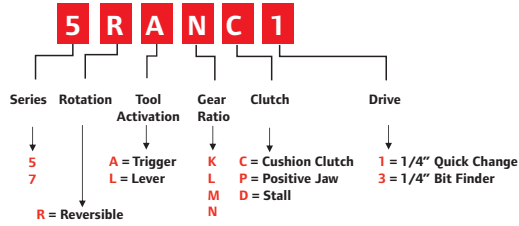

20 & 50 Series Air Nutrunners

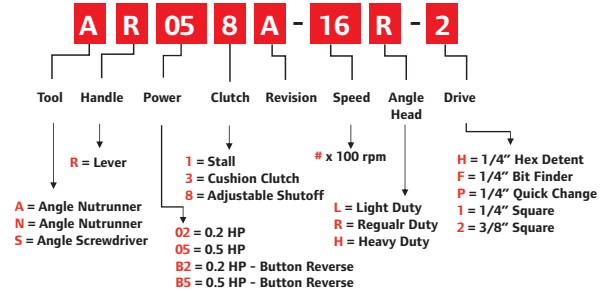

QA Series Air Nutrunners

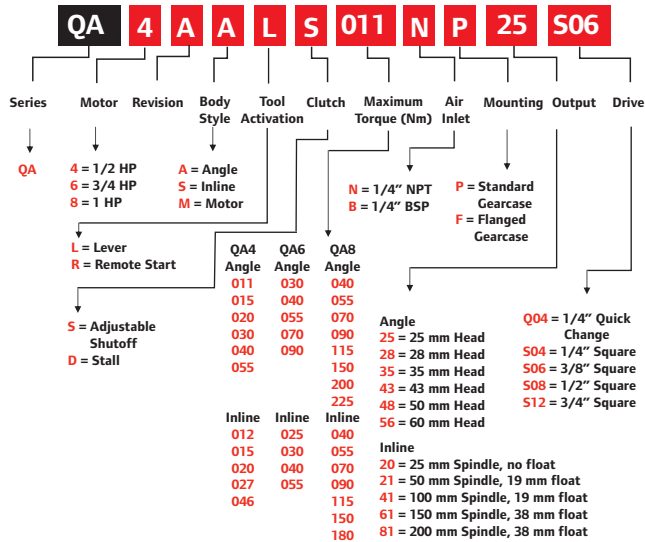

5 & 7 Series Air Nutrunners

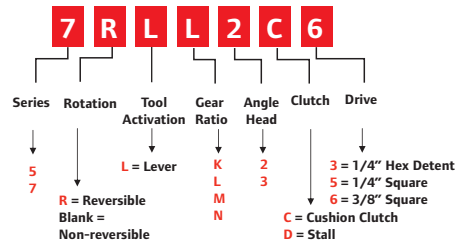

Model Identification Guide

QC Air Tool Qualifiers

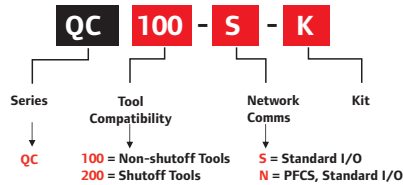

1, 5, 6 & 7 Series Air Inline & Pistol Drills

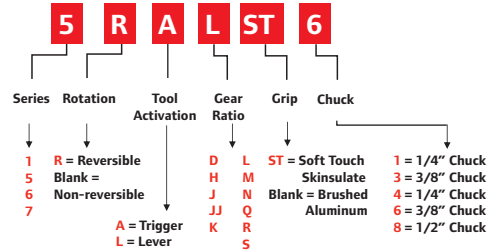

Q2 Series Air Drills

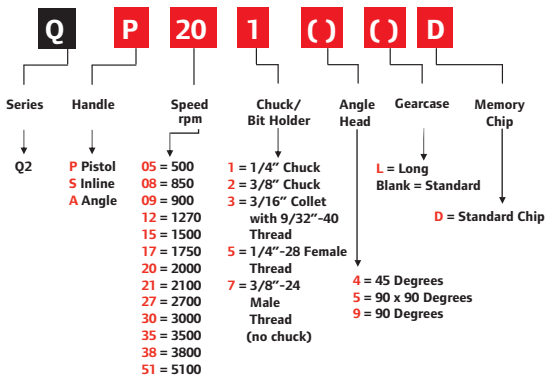

20 & 50 Series Air Drills

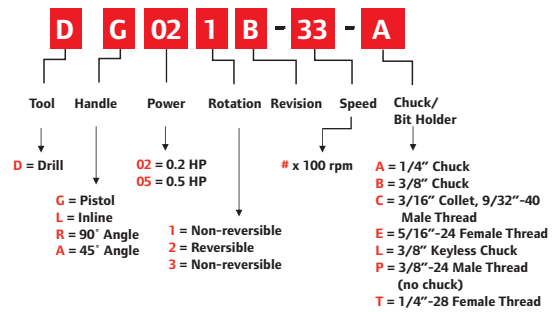

728 Series Air Pistol Drills

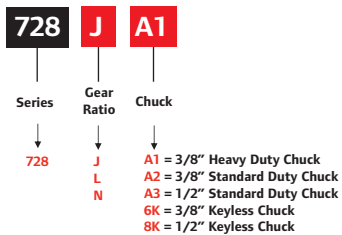

1, 5, 6 & 7 Series Air Angle Drills

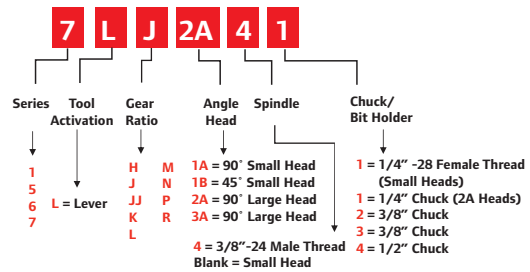

Clutch Selections

Air Screwdrivers & Nutrunners

Selection of the appropriate clutch arrangement for your application is one of the first critical steps in specification. IR offers four basic types — adjustable precision shut-off, adjustable cushion clutch, positive jaw, and stall. The following introduction, coupled with the “Types of Joints” table on the following page, will help you define your requirements.

Adjustable Precision Shut-Off Clutch

Designed for critical fastening applications involving plastics, composites, or metals that require precise torque control. Automatic shut-off reduces air consumption and torque reaction.

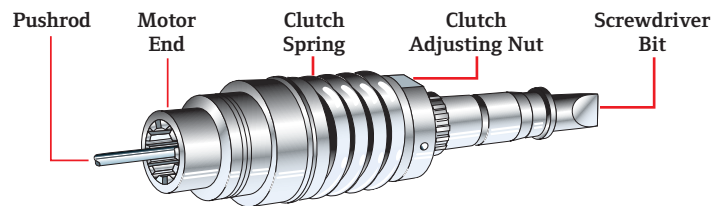

Adjustable Cushion Clutch

Steel balls rolling between indented plates provide smooth disengaging at preset torque while minimizing vibration to the operator. Very good general-purpose torque limiting clutch.

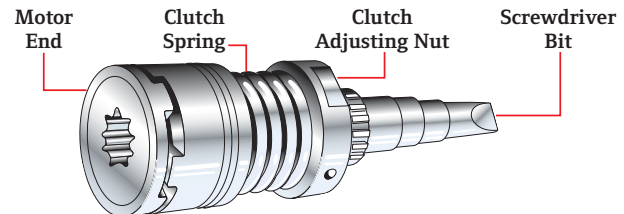

Positive Jaw Clutch

Designed for applications where driving torque may exceed final seating torque as in wood and self-tapping applications. Applied torque is controlled by the operator and can be limited by regulating air line pressure.

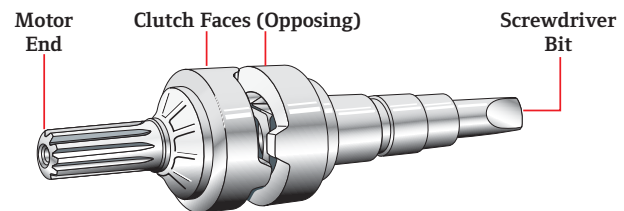

Stall



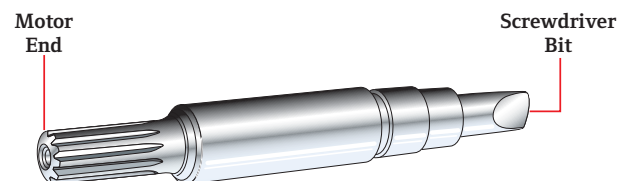





Designed for soft pull applications in wood and other materials not requiring critical torque control. Applied torque is controlled by the operator and can be limited by regulating air line pressure.

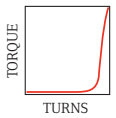

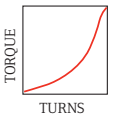
Clutch Selection Chart

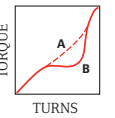
Air Screwdrivers & Nutrunners

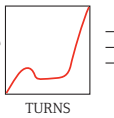
Types of Joints

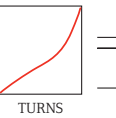
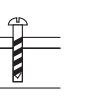
	Free Running-Slam (Hard Drive)	Compressing Gaskets (Soft Draw)	Self-Tapping Screws	Sheet Metal Screws	Wood Screws
Select the Clutch to Fit Your Job   <p>Resistance low at start and during rundown but peaks suddenly as bolt head seats.</p>	  <p>Turning resistance gradually increases as squeeze progresses to final turn.</p>	  <p>Initial resistance high through tapping travel, easing off until sudden (B) or gradual (A) stop.</p>	  <p>Starting torque builds until penetration made, then resistance slacks off until head seats.</p>	  <p>Low resistance at start builds gradually through entire rundown until head seats.</p>	
Adjustable Precision Shut-Off Clutch	EXCELLENT for all screw sizes where precise torque control is required.	BEST for all screw sizes where precise torque control is required.	BEST for all screw sizes except where tapping torque exceeds final torque.	EXCELLENT for all size screws — not suitable if tapping torque exceeds stripping torque.	Not recommended.
Adjustable Cushion Clutch	VERY GOOD for most screw sizes where torque control is IMPORTANT.	VERY GOOD for most screw sizes where torque control is IMPORTANT.	VERY GOOD for all screw sizes where tapping torque does not exceed final torque.	GOOD for most screws where final torque exceeds tapping torque.	FAIR for all screw sizes.
Positive Jaw Clutch	FAIR for all sizes where close torque control is not required.	GOOD for most screws where close torque control is not required.	GOOD where tapping torque greatly exceeds final torque.	VERY GOOD where sheets are not aligned — GOOD where tapping torque is higher than final torque.	BEST for all screw sizes.
Stall	GOOD for all screw sizes in hands of experienced operators.	GOOD for large and medium screws — must be adjusted to run rather slowly for small screws.	Not recommended unless stripping torque is considerably higher than tapping torque.	Not recommended unless stripping torque is considerably higher than tapping torque.	GOOD for large and medium screws — must be adjusted to turn slowly for small screws.

Torque Table Guide

*Suggested Tightening
Torque Values for Nonferrous
Threaded Fasteners*

Torque Table

The following suggested tightening torques provide an excellent starting point for determining torque requirements. Remember, you may need to increase or reduce these numbers based on the individual joint.

Bolt Size	18-8 Stainless Steel	Brass	Silicon Bronze	Aluminum 2024-T4	316 Stainless Steel	Monel	Nylon
VALUES (IN-LBS)							
2 – 56	2.5	2.0	2.3	1.4	2.6	2.5	0.44
2 – 64	3.0	2.5	2.8	1.7	3.2	3.1	
3 – 48	3.9	3.2	3.6	2.1	4.0	4.0	
3 – 56	4.4	3.6	4.1	2.4	4.6	4.5	
4 – 40	5.2	4.3	4.8	2.9	5.5	5.3	1.19
4 – 48	6.6	5.4	6.1	3.6	6.9	6.7	
5 – 40	7.7	6.3	7.1	4.2	8.1	7.8	
5 – 44	9.4	7.7	8.7	5.1	9.8	9.6	
6 – 32	9.6	7.9	8.9	5.3	10.1	9.8	2.14
6 – 40	12.1	9.9	11.2	6.6	12.7	12.3	
8 – 32	19.8	16.2	18.4	10.8	20.7	20.2	4.30
8 – 36	22.0	18.0	20.4	12.0	23.0	22.4	
10 – 24	22.8	18.6	21.2	13.8	23.8	25.9	6.61
10 – 32	31.7	25.9	29.3	19.2	33.1	34.9	8.20
1/4" – 20	75.2	61.5	68.8	45.6	78.8	85.3	16.00
1/4" – 28	94.0	77.0	87.0	57.0	99.0	106.0	20.80
5/16" – 18	132.0	107.0	123.0	80.0	138.0	149.0	34.90
5/16" – 24	142.0	116.0	131.0	86.0	147.0	160.0	
3/8" – 16	236.0	192.0	219.0	143.0	247.0	266.0	
3/8" – 24	259.0	212.0	240.0	157.0	271.0	294.0	
7/16" – 14	376.0	317.0	349.0	228.0	393.0	427.0	
7/16" – 20	400.0	327.0	371.0	242.0	418.0	451.0	
1/2" – 13	517.0	422.0	480.0	313.0	542.0	584.0	
1/2" – 20	541.0	443.0	502.0	328.0	565.0	613.0	
9/16" – 12	682.0	558.0	632.0	413.0	713.0	774.0	
9/16" – 18	752.0	615.0	697.0	456.0	787.0	855.0	
5/8" – 11	1110.0	907.0	1030.0	715.0	1160.0	1330.0	
5/8" – 18	1244.0	1016.0	1154.0	798.0	1301.0	1482.0	
3/4" – 10	1530.0	1249.0	1416.0	980.0	1582.0	1832.0	
3/4" – 16	1490.0	1220.0	1382.0	958.0	1558.0	1790.0	
7/8" – 9	2328.0	1905.0	2140.0	1495.0	2430.0	2775.0	
7/8" – 14	2318.0	1895.0	2130.0	1490.0	2420.0	2755.0	
1" – 8	3440.0	2815.0	3185.0	2205.0	3595.0	4130.0	
1" – 14	3110.0	2545.0	2885.0	1995.0	3250.0	3730.0	
1 1/8" – 7	413.0 ft-lbs	337.0 ft-lbs	383.0 ft-lbs	265.0 ft-lbs	432.0 ft-lbs	499.0 ft-lbs	
1-1/8" – 12	390.0 ft-lbs	318.0 ft-lbs	361.0 ft-lbs	251.0 ft-lbs	408.0 ft-lbs	470.0 ft-lbs	
1-1/4" – 7	523.0 ft-lbs	428.0 ft-lbs	485.0 ft-lbs	336.0 ft-lbs	546.0 ft-lbs	627.0 ft-lbs	
1-1/4" – 12	480.0 ft-lbs	349.0 ft-lbs	447.0 ft-lbs	308.0 ft-lbs	504.0 ft-lbs	575.0 ft-lbs	
1-1/2" – 6	888.0 ft-lbs	727.0 ft-lbs	822.0 ft-lbs	570.0 ft-lbs	930.0 ft-lbs	1064.0 ft-lbs	
1-1/2" – 12	703.0 ft-lbs	575.0 ft-lbs	651.0 ft-lbs	450.0 ft-lbs	732.0 ft-lbs	840.0 ft-lbs	

This table is offered as the suggested maximum torquing values for threaded products and is only a guide. Actual tests were conducted on dry or near-dry products. Mating parts were wiped clean of chips and foreign matter. A lubricated bolt requires less torque to attain the same clamping force as a nonlubricated bolt. All values shown on chart except for nylon represent a safe working torque; in the case of nylon only, the figures represent breaking torque.

Drilling Guide

Selection Chart

Suggested surface speeds for high-speed steel drills in various materials.

Material	Speed in SFM
Alloy steel (300 to 400 Brinell)	20 to 30
Stainless steel	30 to 40
Automotive steel forgings	40 to 50
Tool steel, 1.2C	50 to 60
Steel, .4C to .5C	70 to 80
Mild machinery, .2C to .3C	80 to 110
Hard-chilled cast iron	30 to 40
Medium-hard cast iron	70 to 100
Soft cast iron	100 to 150
Malleable iron	80 to 90
Monel metal	40 to 50
High tensile-strength bronze	70 to 150
Ordinary brass and bronze	200 to 300
Aluminum and its alloys	200 to 300
Magnesium and its alloys	250 to 400
Slate, marble and stone	15 to 25
Bakelite and similar material	100 to 150
Wood	300 to 400

Note: Carbon-steel twist drills should be run at speeds of 40 to 50 percent of those given above.

Drilling Speed (rpm) = 0.75 x Free Speed (rpm)

Hole Diameter In	Surface Speed, Feet Per Minute												
	30	40	50	60	70	80	90	100	110	150	200	300	400
DRILLING SPEED, RPM (OPTIMUM OPERATING SPEED – NOT CATALOGED FREE SPEED)													
1/16"	1800	2400	3000	3600	4200	4900	5500	6100	6700	9000	12,000	18,000	24,000
1/8"	900	1200	1500	1800	2100	2400	2700	3000	3400	4600	6100	9200	12,000
3/16"	600	800	1000	1200	1400	1600	1800	2000	2200	3100	4100	6100	8100
1/4"	450	600	750	900	1100	1200	1400	1500	1700	2300	3100	4600	6100
5/16"	350	500	600	750	850	1000	1100	1200	1300	1800	2400	3700	4900
3/8"	300	400	500	600	700	800	900	1000	1100	1500	2000	3000	4000
1/2"	200	300	400	450	550	600	650	750	850	1100	1500	2300	3000

Index

Model Number	Description	Page
1		
100P4	Pistol Grip Pulse Tool, Trigger Start	125, 127, 137, 138
100PQ1	Pistol Grip Pulse Tool, Trigger Start	125, 128, 137
100SQ1	Inline/Angle Pulse Tool, Inline Lever Start	129, 137
1100P	Pistol Grip Pulse Tool, Trigger Start	125, 128, 137
1100PS4	Pistol Grip Pulse Tool, Trigger Start	125, 131, 137
130P4	Pistol Grip Pulse Tool, Trigger Start	125, 127, 137, 138
140P6	Pistol Grip Pulse Tool, Trigger Start	125, 127, 137, 138
180PQ1	Pistol Grip Pulse Tool, Trigger Start	125, 128, 137
180SQ1	Inline/Angle Pulse Tool, Inline Lever Start	129, 137
1900PS4	Pistol Grip Pulse Tool, Trigger Start	125, 131, 137
1AL1	Air Production Drill, Trigger Start	140, 142
1LJ1A1	Air Production Drill, Lever Start	161
1LL1A1	Air Production Drill, Lever Start	141, 161
1P06ST4	Air Production Drill, Trigger Start	140, 142
1P09ST4	Air Production Drill, Trigger Start	140, 142
1P38ST4	Air Production Drill, Trigger Start	140, 142
1RAMC1	Pistol Grip Air Screwdriver, Trigger + Push-to-Start	63
1RANC1	Pistol Grip Air Screwdriver, Trigger + Push-to-Start	55, 63
1RLMC1	Inline Air Screwdriver, Lever Start	78, 84
1RLN2S3	Angle Air Nutrunner, Lever Start	95
1RLN2S5	Angle Air Nutrunner, Lever Start	94, 95
1RLNC1	Inline Air Screwdriver, Lever Start	78, 84
1RLNS1	Inline Air Screwdriver, Push-to-Start	79
1RPLS1	Inline Air Screwdriver, Push-to-Start	79
1RPMC1	Inline Air Screwdriver, Push-to-Start	84
1RPMS1	Inline Air Screwdriver, Push-to-Start	79
1RPNC1	Inline Air Screwdriver, Push-to-Start	84
1RPNS1	Inline Air Screwdriver, Push-to-Start	78, 79
1RPQS1	Inline Air Screwdriver, Push-to-Start	78, 79
1RTMS1	Pistol Grip Air Screwdriver, Trigger + Push-to-Start	56
1RTNS1	Pistol Grip Air Screwdriver, Trigger + Push-to-Start	55, 56
1RTQS1	Pistol Grip Air Screwdriver, Trigger + Push-to-Start	55, 56
2		
280P	Pistol Grip Pulse Tool, Trigger Start	125, 128, 137
280PQ1	Pistol Grip Pulse Tool, Trigger Start	128, 137
280SQ1	Inline/Angle Pulse Tool, Inline Lever Start	129, 137

Model Number	Description	Page
3		
380P	Pistol Grip Pulse Tool, Trigger Start	125, 128, 137
380PQ1	Pistol Grip Pulse Tool, Trigger Start	128, 137
380SQ1	Inline/Angle Pulse Tool, Inline Lever Start	129, 137
4		
40PSQ1	Pistol Grip Pulse Tool, Trigger Start	125, 130, 137, 138
41AA6LTH4	Angle Air Nutrunner, Lever Start	99
41AA6LTS6	Angle Air Nutrunner, Lever Start	94, 99
41AA9LTH4	Angle Air Nutrunner, Lever Start	99
41AA9LTS6	Angle Air Nutrunner, Lever Start	94, 99
41PA10PSQ4	Pistol Grip Air Screwdriver, Push-to-Start	62
41PA10TPQ4	Pistol Grip Air Screwdriver, Trigger + Push-to-Start	62
41PA10TSQ4	Pistol Grip Air Screwdriver, Trigger Start	55, 62
41PA16PSQ4	Pistol Grip Air Screwdriver, Push-to-Start	62
41PA16TPQ4	Pistol Grip Air Screwdriver, Trigger + Push-to-Start	62
41PA16TSQ4	Pistol Grip Air Screwdriver, Trigger Start	62
41PA24PSQ4	Pistol Grip Air Screwdriver, Push-to-Start	62
41PA24TSQ4	Pistol Grip Air Screwdriver, Trigger Start	55, 62
41PA8PSQ4	Pistol Grip Air Screwdriver, Push-to-Start	62
41PA8TPQ4	Pistol Grip Air Screwdriver, Trigger + Push-to-Start	62
41PA8TSQ4	Pistol Grip Air Screwdriver, Trigger Start	55, 62
41PC10TSQ4	Pistol Grip Air Screwdriver, Trigger Start	55, 66
41PC17TSQ4	Pistol Grip Air Screwdriver, Trigger Start	66
41PC25TSQ4	Pistol Grip Air Screwdriver, Trigger Start	55, 66
41PC8TSQ4	Pistol Grip Air Screwdriver, Trigger Start	55, 66
41PD10TSQ4	Pistol Grip Air Screwdriver, Trigger Start	55, 76
41PD17TSQ4	Pistol Grip Air Screwdriver, Trigger Start	76
41PD25TSQ4	Pistol Grip Air Screwdriver, Trigger Start	55, 76
41PD8TSQ4	Pistol Grip Air Screwdriver, Trigger Start	55, 76
41PP10TSQ4	Pistol Grip Air Screwdriver, Trigger Start	55, 71
41PP17TSQ4	Pistol Grip Air Screwdriver, Trigger Start	71
41PP25TSQ4	Pistol Grip Air Screwdriver, Trigger Start	55, 71
41PP8TSQ4	Pistol Grip Air Screwdriver, Trigger Start	55, 71
41SA10LPQ4	Inline Air Screwdriver, Lever + Push-to-Start	78, 83
41SA10PSQ4	Inline Air Screwdriver, Push-to-Start	83
41SA17LPQ4	Inline Air Screwdriver, Lever + Push-to-Start	83
41SA17PSQ4	Inline Air Screwdriver, Push-to-Start	83
41SA25LPQ4	Inline Air Screwdriver, Lever + Push-to-Start	83
41SA8LPQ4	Inline Air Screwdriver, Lever + Push-to-Start	78, 83
41SA8PSQ4	Inline Air Screwdriver, Push-to-Start	83
41SC10LTQ4	Inline Air Screwdriver, Lever Start	78, 87
41SC10PSQ4	Inline Air Screwdriver, Push-to-Start	87

Index

Model Number	Description	Page	Model Number	Description	Page
41SC17LTQ4	Inline Air Screwdriver, Lever Start	78, 87	5LN2A43	Air Production Drill, Lever Start (90° Chuck)	141, 165
41SC17PSQ4	Inline Air Screwdriver, Push-to-Start	87	5LN3	Air Production Drill, Lever Start	141, 159
41SC25LTQ4	Inline Air Screwdriver, Lever Start	78, 87	5RALC1	Pistol Grip Air Screwdriver, Trigger Start	67
41SC25PSQ4	Inline Air Screwdriver, Push-to-Start	87	5RALC3	Pistol Grip Air Screwdriver, Trigger Start	67
41SC8LTQ4	Inline Air Screwdriver, Lever Start	78, 87	5RALD1	Pistol Grip Air Screwdriver, Trigger Start	55, 75
41SC8PSQ4	Inline Air Screwdriver, Push-to-Start	87	5RALP1	Pistol Grip Air Screwdriver, Trigger Start	55, 72
41SD10LTQ4	Inline Air Screwdriver, Lever Start	78, 93	5RALST6	Air Production Drill, Trigger Start	140, 148
41SD17LTQ4	Inline Air Screwdriver, Lever Start	78, 93	5RANC1	Pistol Grip Air Screwdriver, Trigger Start	55, 67
41SD25LTQ4	Inline Air Screwdriver, Lever Start	78, 93	5RAND1	Pistol Grip Air Screwdriver, Trigger Start	55
41SD8LTQ4	Inline Air Screwdriver, Lever Start	78, 93	5RANP1	Pistol Grip Air Screwdriver, Trigger Start	55, 72
41SP10LTQ4	Inline Air Screwdriver, Lever Start	78, 90	5RANST6	Air Production Drill, Trigger Start	148
41SP17LTQ4	Inline Air Screwdriver, Lever Start	78, 90	5RANST8	Air Production Drill, Trigger Start	148
41SP25LTQ4	Inline Air Screwdriver, Lever Start	78, 90	5RLK2C3	Angle Air Nutrunner, Lever Start	106
41SP8LTQ4	Inline Air Screwdriver, Lever Start	78, 90	5RLK2C5	Angle Air Nutrunner, Lever Start	94, 106
45PS3	Pistol Grip Pulse Tool, Trigger Start	125, 130, 137, 138	5RLK2D6	Angle Air Nutrunner, Lever Start	94, 110
45PSQ1	Pistol Grip Pulse Tool, Trigger Start	130, 137, 138	5RLL2C5	Angle Air Nutrunner, Lever Start	94, 106
46P3	Pistol Grip Pulse Tool, Trigger Start	125, 127, 137, 138	5RLL2D6	Angle Air Nutrunner, Lever Start	94, 110
46PQ1	Pistol Grip Pulse Tool, Trigger Start	125, 127, 137, 138	5RLLC1	Inline Air Screwdriver, Lever Start	78, 88
5			5RLN2C3	Angle Air Nutrunner, Lever Start	106
500A	Inline/Angle Pulse Tool, Angle Lever Start	129, 137	5RLN2C6	Angle Air Nutrunner, Lever Start	94, 106
500P	Pistol Grip Pulse Tool, Trigger Start	125, 128, 137	5RLN2D6	Angle Air Nutrunner, Lever Start	94, 110
500PQ1	Pistol Grip Pulse Tool, Trigger Start	128, 137	5RLNC1	Inline Air Screwdriver, Lever Start	78, 88
500PS3	Pistol Grip Pulse Tool, Trigger Start	125, 131, 137	5RLNC3	Inline Air Screwdriver, Lever Start	88
54041819	Torque Tube	182	6		
54044227	Torque Tube	182	6ADST4	Air Production Drill, Trigger Start	140, 149
54044417	Torque Tube	182	6AHST4	Air Production Drill, Trigger Start	149
55PS3	Pistol Grip Pulse Tool, Trigger Start	125, 130, 137, 138	6AJJST4	Air Production Drill, Trigger Start	149
55PSQ1	Pistol Grip Pulse Tool, Trigger Start	130, 137, 138	6AJST4	Air Production Drill, Trigger Start	140, 149
5AHST4	Air Production Drill, Trigger Start	140, 148	6AKST4	Air Production Drill, Trigger Start	140, 149
5AJST4	Air Production Drill, Trigger Start	148	6ALST4	Air Production Drill, Trigger Start	140, 149
5AKST4	Air Production Drill, Trigger Start	140, 148	6AMST6	Air Production Drill, Trigger Start	149
5ALST4	Air Production Drill, Trigger Start	148	6ARST6	Air Production Drill, Trigger Start	140, 149
5ANST6	Air Production Drill, Trigger Start	140, 148	6ASST6	Air Production Drill, Trigger Start	140, 149
5LH1B1	Air Production Drill, Lever Start (45° Small Angle Head)	141, 165	6LH1	Air Production Drill, Lever Start	141, 159
5LJ1	Air Production Drill, Lever Start	141, 159	6LH1A1	Air Production Drill, Lever Start (90° Small Angle Head)	166
5LK1	Air Production Drill, Lever Start	159	6LJ1	Air Production Drill, Lever Start	159
5LK1A1	Air Production Drill, Lever Start (90° Small Angle Head)	165	6LJJ1	Air Production Drill, Lever Start	159
5LK1B1	Air Production Drill, Lever Start (45° Small Angle Head)	165	6LJJ1A1	Air Production Drill, Lever Start (90° Small Angle Head)	166
5LL1	Air Production Drill, Lever Start	141, 159	6LK1	Air Production Drill, Lever Start	141, 159
5LL1A1	Air Production Drill, Lever Start (90° Small Angle Head)	165	6LK1A1	Air Production Drill, Lever Start (90° Small Angle Head)	141, 166
5LL2A41	Air Production Drill, Lever Start (90° Chuck)	165	6LK2A41	Air Production Drill, Lever Start (90° Chuck)	166
			6LL1	Air Production Drill, Lever Start	159
			6LL1A1	Air Production Drill, Lever Start (90° Small Angle Head)	166
			6LL2A42	Air Production Drill, Lever Start (90° Chuck)	166
			6LP3A43	Air Production Drill, Lever Start (90° Chuck)	166

Index

Model Number	Description	Page	Model Number	Description	Page
6LR3	Air Production Drill, Lever Start	141, 159	7LJ2A41	Air Production Drill, Lever Start (90° Chuck)	167
6LR3A44	Air Production Drill, Lever Start (90° Chuck)	141, 166	7LK1A1	Air Production Drill, Lever Start (90° Small Angle Head)	141, 167
7			7LL3A42	Air Production Drill, Lever Start (90° Chuck)	167
700A	Inline/Angle Pulse Tool, Angle Lever Start	129, 137	7LM3A43	Air Production Drill, Lever Start (90° Chuck)	167
700P	Pistol Grip Pulse Tool, Trigger Start	125, 128, 137	7LN3A44	Air Production Drill, Lever Start (90° Chuck)	141, 167
700PS3	Pistol Grip Pulse Tool, Trigger Start	125, 131, 137	7RALC1	Pistol Grip Air Screwdriver, Trigger Start	55, 67
70PS3	Pistol Grip Pulse Tool, Trigger Start	125, 130, 137, 138	7RALD1	Pistol Grip Air Screwdriver, Trigger Start	55, 75
7165-B	Electrode Dresser	175	7RAMC1	Pistol Grip Air Screwdriver, Trigger Start	55, 67
728J6K	Air Production Drill, Trigger Start	153	7RAMP1	Pistol Grip Air Screwdriver, Trigger Start	55, 72
728JA1	Air Production Drill, Trigger Start	140, 153	7RANP1	Pistol Grip Air Screwdriver, Trigger Start	55, 72
728L6K	Air Production Drill, Trigger Start	153	7RAQT4	Tapper, Trigger Start	172
728LA2	Air Production Drill, Trigger Start	140, 153	7RL2C6	Angle Air Nutrunner, Lever Start	94, 106
728N8K	Air Production Drill, Trigger Start	153	7RL3C6	Angle Air Nutrunner, Lever Start	106
728NA3	Air Production Drill, Trigger Start	140, 153	7RL3D6	Angle Air Nutrunner, Lever Start	94, 110
7429-D	Tapper, Push-Pull	173	7RLLC1	Inline Air Screwdriver, Lever Start	78, 88
7438-D	Air Production Drill, Lever Start Flat Angle	168	7RLM3C6	Angle Air Nutrunner, Lever Start	94, 106
7439-D	Air Production Drill, Lever Start Flat Angle	168	7RLM3D6	Angle Air Nutrunner, Lever Start	94, 110
7441-D	Air Production Drill, Lever Start Flat Angle	141, 168	7RLMC1	Inline Air Screwdriver, Lever Start	78, 88
7453-D	Angle Air Nutrunner, Lever Start	111	7RLN3D6	Angle Air Nutrunner, Lever Start	94, 110
7456-D	Angle Air Nutrunner, Lever Start	111	8		
7672-A18	Trigger Start Woodworking Screwdriver	69	8038-E	Electrode Dresser	175
772	Lightweight Riveter	174	8039-E	Electrode Dresser	175
7845-E	Air Production Drill, Trigger Start	140, 151	8040-E	Electrode Dresser	175
7846-E	Air Production Drill, Trigger Start	151	8506-ADB	Air Production Drill, QRT Trigger Start	140, 152
7847-E	Air Production Drill, Trigger Start	140, 151	8506-ADK	Air Production Drill, QRT Trigger Start	152
7848-E	Air Production Drill, Trigger Start	151	8506-APR-A	Pistol Grip Air Screwdriver, Trigger + Push-to-Start	68
7849-E	Air Production Drill, Trigger Start	140, 151	8506-APR-P	Pistol Grip Air Screwdriver, Trigger Start	70
7850-E	Air Production Drill, Lever Start	141, 160	8506-ATA	Tapper, QRT	173
7851-E	Air Production Drill, Lever Start	160	8506-ATB	Tapper, QRT	173
7852-E	Air Production Drill, Lever Start	160	8506-ATC	Tapper, QRT	173
7853-E	Air Production Drill, Lever Start	160	8506-BPR-D	Pistol Grip Air Screwdriver, Trigger Start	77
7854-E	Air Production Drill, Lever Start	141, 160	8509-ADB	Air Production Drill, QRT Trigger Start	140, 152
7855-E	Air Production Drill, Lever Start	160	8509-ADK	Air Production Drill, QRT Trigger Start	152
7ADST4	Air Production Drill, Trigger Start	140, 150	8509-APR-A	Pistol Grip Air Screwdriver, Trigger + Push-to-Start	68
7AHST4	Air Production Drill, Trigger Start	150	8509-APR-P	Pistol Grip Air Screwdriver, Trigger Start	70
7AJJST4	Air Production Drill, Trigger Start	140, 150	8509-ATA	Tapper, QRT	173
7AJST4	Air Production Drill, Trigger Start	140, 150	8509-ATB	Tapper, QRT	173
7AKST6	Air Production Drill, Trigger Start	150	8509-ATC	Tapper, QRT	173
7ALST6	Air Production Drill, Trigger Start	140, 150	8509-BPR-D	Pistol Grip Air Screwdriver, Trigger Start	77
7AMST6	Air Production Drill, Trigger Start	150	8515-APR-A	Pistol Grip Air Screwdriver, Trigger + Push-to-Start	68
7ANST8	Air Production Drill, Trigger Start	140, 150	8515-APR-P	Pistol Grip Air Screwdriver, Trigger Start	70
7AQST8	Air Production Drill, Trigger Start	150	8515-BPR-D	Pistol Grip Air Screwdriver, Trigger Start	77
7LH1A1	Air Production Drill, Lever Start (90° Small Angle Head)	167	8521-APR-A	Pistol Grip Air Screwdriver, Trigger + Push-to-Start	68
7LJ1A1	Air Production Drill, Lever Start (90° Small Angle Head)	167	8521-APR-P	Pistol Grip Air Screwdriver, Trigger Start	70

Index

Model Number	Description	Page	Model Number	Description	Page
8521-BPR-D	Pistol Grip Air Screwdriver, Trigger Start	77	AR058A-6H-H	Angle Air Nutrunner, Lever Start	98
8683-BPR-D	Pistol Grip Air Screwdriver, Trigger Start	77	AR058A-9R-1	Angle Air Nutrunner, Lever Start	98
8683-BPR-P	Pistol Grip Air Screwdriver, Trigger Start	70	AR058A-9R-2	Angle Air Nutrunner, Lever Start	98
8684-BPR-D	Pistol Grip Air Screwdriver, Trigger Start	77	AR058A-9R-H	Angle Air Nutrunner, Lever Start	98
9			AS028A-15-Q	Inline Air Screwdriver, Lever + Push-to-Start	78, 82
900P	Pistol Grip Pulse Tool, Trigger Start	125, 128, 137	AS028A-8-Q	Inline Air Screwdriver, Lever + Push-to-Start	78, 82
900PS4	Pistol Grip Pulse Tool, Trigger Start	125, 131, 137	AS028A-9-Q	Inline Air Screwdriver, Lever + Push-to-Start	78, 82
90PS4	Pistol Grip Pulse Tool, Trigger Start	125, 130, 137, 138	AS058A-10-Q	Inline Air Screwdriver, Lever + Push-to-Start	82
9RSQ83	Angle Air Nutrunner, Lever Start	94, 110	AS058A-8-Q	Inline Air Screwdriver, Lever + Push-to-Start	82
A			AVC10A1	Lightweight Riveter, Trigger Start	174
AG024A-15-Q	Pistol Grip Air Screwdriver, Push-to-Start	59	AVC10C1	Lightweight Riveter, Trigger Start	174
AG024A-8-Q	Pistol Grip Air Screwdriver, Push-to-Start	59	AVC12A1	Lightweight Riveter, Trigger Start	174
AG024A-9-Q	Pistol Grip Air Screwdriver, Push-to-Start	59	AVC13A1	Lightweight Riveter, Trigger Start	174
AG027-8-Q	Pistol Grip Air Screwdriver, Trigger Start	55, 59	AVC26A1	Lightweight Riveter, Trigger Start	174
AG027A-15-Q	Pistol Grip Air Screwdriver, Trigger Start	55, 59	AVC26B1	Lightweight Riveter, Trigger Start	174
AG027A-26-Q	Pistol Grip Air Screwdriver, Trigger + Push-to-Start	55, 59	B		
AG027A-9-Q	Pistol Grip Air Screwdriver, Trigger Start	59	BHD-15	Spring Balancer	178
AG028A-15-Q	Pistol Grip Air Screwdriver, Trigger + Push-to-Start	59	BHD-20	Spring Balancer	178
AG028A-8-Q	Pistol Grip Air Screwdriver, Trigger + Push-to-Start	59	BHD-25	Spring Balancer	178
AG028A-9-Q	Pistol Grip Air Screwdriver, Trigger + Push-to-Start	59	BHD-30	Spring Balancer	178
AG054A-10-Q	Pistol Grip Air Screwdriver, Push-to-Start	60	BHD-35	Spring Balancer	178
AG054A-16-Q	Pistol Grip Air Screwdriver, Push-to-Start	60	BHD-45	Spring Balancer	178
AG054A-24-Q	Pistol Grip Air Screwdriver, Push-to-Start	60	BHD-55	Spring Balancer	178
AG054A-8-Q	Pistol Grip Air Screwdriver, Push-to-Start	60	BHD-65	Spring Balancer	178
AG057A-10-Q	Pistol Grip Air Screwdriver, Trigger Start	60	BIDS-10	Spring Balancer	178
AG057A-16-Q	Pistol Grip Air Screwdriver, Trigger Start	60	BIDS-14	Spring Balancer	178
AG057A-24-Q	Pistol Grip Air Screwdriver, Trigger Start	60	BIDS-18	Spring Balancer	178
AG057A-8-Q	Pistol Grip Air Screwdriver, Trigger Start	60	BIDS-22	Spring Balancer	178
AG058A-10-Q	Pistol Grip Air Screwdriver, Trigger + Push-to-Start	60	BIDS-26	Spring Balancer	178
AG058A-16-Q	Pistol Grip Air Screwdriver, Trigger + Push-to-Start	60	BIDS-7	Spring Balancer	178
AG058A-24-Q	Pistol Grip Air Screwdriver, Trigger + Push-to-Start	60	BLD1	Spring Balancer	177
AG058A-8-Q	Pistol Grip Air Screwdriver, Trigger + Push-to-Start	60	BLD2	Spring Balancer	177
AR058A-16R-1	Angle Air Nutrunner, Lever Start	98	BLD3	Spring Balancer	177
AR058A-16R-2	Angle Air Nutrunner, Lever Start	98	BMDL-10	Spring Balancer	177
AR058A-16R-H	Angle Air Nutrunner, Lever Start	98	BMDL-12	Spring Balancer	177
AR058A-24R-1	Angle Air Nutrunner, Lever Start	98	BMDL-4	Spring Balancer	177
AR058A-24R-2	Angle Air Nutrunner, Lever Start	98	BMDL-6	Spring Balancer	177
AR058A-24R-H	Angle Air Nutrunner, Lever Start	98	BMDL-8	Spring Balancer	177
AR058A-6H-2	Angle Air Nutrunner, Lever Start	98	BMDLL-10	Spring Balancer	177
AR058A-6H-F	Angle Air Nutrunner, Lever Start	98	BMDLL-4	Spring Balancer	177
			BMDLL-6	Spring Balancer	177
			BMDLL-8	Spring Balancer	177
			BMDS-2	Spring Balancer	177
			BMDS-4	Spring Balancer	177
			BMDS-6	Spring Balancer	177
			BMDS-8	Spring Balancer	177
			BSD-100	Spring Balancer	179

Index

Model Number	Description	Page
BSD-120	Spring Balancer	179
BSD-140	Spring Balancer	179
BSD-150	Spring Balancer	179
BSD-165	Spring Balancer	179
BSD-20	Spring Balancer	179
BSD-30	Spring Balancer	179
BSD-40	Spring Balancer	179
BSD-50	Spring Balancer	179
BSD-60	Spring Balancer	179
BSD-70	Spring Balancer	179
BSD-80	Spring Balancer	179
BSD-90	Spring Balancer	179
BSDL-100	Spring Balancer	179
BSDL-115	Spring Balancer	179
BSDL-130	Spring Balancer	179
BSDL-140	Spring Balancer	179
BSDL-150	Spring Balancer	179
BSDL-20	Spring Balancer	179
BSDL-25	Spring Balancer	179
BSDL-35	Spring Balancer	179
BSDL-45	Spring Balancer	179
BSDL-50	Spring Balancer	179
BSDL-60	Spring Balancer	179
BSDL-70	Spring Balancer	179
BSDL-80	Spring Balancer	179
BSDL-90	Spring Balancer	179

D

DA053B-27-T	Air Production Drill, Lever Start (45° Small Angle Head)	164
DA053B-41-T	Air Production Drill, Lever Start (45° Small Angle Head)	164
DA053B-52-T	Air Production Drill, Lever Start (45° Small Angle Head)	164
DG021B-10-A	Air Production Drill, Trigger Start	140, 145
DG021B-10-B	Air Production Drill, Trigger Start	145
DG021B-19-A	Air Production Drill, Trigger Start	145
DG021B-19-B	Air Production Drill, Trigger Start	145
DG021B-220-A	Air Production Drill, Trigger Start	145
DG021B-220-P	Air Production Drill, Trigger Start	145
DG021B-33-A	Air Production Drill, Trigger Start	140, 144, 145
DG021B-33-P	Air Production Drill, Trigger Start	145
DG021B-5-A	Air Production Drill, Trigger Start	140, 145
DG021B-5-B	Air Production Drill, Trigger Start	145
DG021B-64-A	Air Production Drill, Trigger Start	140, 145
DG021B-64-P	Air Production Drill, Trigger Start	145
DG022B-15-A	Air Production Drill, Trigger Start	144
DG022B-15-B	Air Production Drill, Trigger Start	144
DG022B-15-L	Air Production Drill, Trigger Start	144
DG022B-15-P	Air Production Drill, Trigger Start	144
DG022B-26-A	Air Production Drill, Trigger Start	140, 144

Model Number	Description	Page
DG022B-26-P	Air Production Drill, Trigger Start	144
DG022B-4-A	Air Production Drill, Trigger Start	140, 144
DG022B-4-P	Air Production Drill, Trigger Start	144
DG022B-50-A	Air Production Drill, Trigger Start	144
DG022B-8-A	Air Production Drill, Trigger Start	140, 144
DG022B-8-B	Air Production Drill, Trigger Start	144
DG022B-8-P	Air Production Drill, Trigger Start	144
DG051B-11-A	Air Production Drill, Trigger Start	140, 147
DG051B-11-B	Air Production Drill, Trigger Start	147
DG051B-11-P	Air Production Drill, Trigger Start	147
DG051B-15-A	Air Production Drill, Trigger Start	140, 147
DG051B-15-B	Air Production Drill, Trigger Start	147
DG051B-15-P	Air Production Drill, Trigger Start	147
DG051B-180-A	Air Production Drill, Trigger Start	147
DG051B-180-P	Air Production Drill, Trigger Start	147
DG051B-27-A	Air Production Drill, Trigger Start	147
DG051B-27-B	Air Production Drill, Trigger Start	147
DG051B-27-P	Air Production Drill, Trigger Start	147
DG051B-33-A	Air Production Drill, Trigger Start	140, 147
DG051B-33-B	Air Production Drill, Trigger Start	147
DG051B-33-P	Air Production Drill, Trigger Start	147
DG051B-4-A	Air Production Drill, Trigger Start	140, 147
DG051B-4-B	Air Production Drill, Trigger Start	147
DG051B-4-P	Air Production Drill, Trigger Start	147
DG051B-52-A	Air Production Drill, Trigger Start	140, 147
DG051B-52-B	Air Production Drill, Trigger Start	147
DG051B-52-P	Air Production Drill, Trigger Start	147
DG051B-6-A	Air Production Drill, Trigger Start	147
DG051B-6-B	Air Production Drill, Trigger Start	147
DG051B-6-P	Air Production Drill, Trigger Start	147
DG052B-10-A	Air Production Drill, Trigger Start	140, 146
DG052B-10-B	Air Production Drill, Trigger Start	146
DG052B-10-P	Air Production Drill, Trigger Start	146
DG052B-15-B	Air Production Drill, Trigger Start	146
DG052B-15-L	Air Production Drill, Trigger Start	146
DG052B-15-P	Air Production Drill, Trigger Start	146
DG052B-25-B	Air Production Drill, Trigger Start	140, 146
DG052B-25-L	Air Production Drill, Trigger Start	146
DG052B-30-A	Air Production Drill, Trigger Start	146
DG052B-30-B	Air Production Drill, Trigger Start	146
DG052B-30-L	Air Production Drill, Trigger Start	146
DG052B-30-P	Air Production Drill, Trigger Start	146
DG052B-4-B	Air Production Drill, Trigger Start	140, 146
DG052B-4-P	Air Production Drill, Trigger Start	146
DG052B-50-B	Air Production Drill, Trigger Start	140, 146
DG052B-50-L	Air Production Drill, Trigger Start	146
DG052B-6-B	Air Production Drill, Trigger Start	146
DG052B-6-P	Air Production Drill, Trigger Start	146
DL021B-10-A	Air Production Drill, Lever Start	156
DL021B-10-B	Air Production Drill, Lever Start	156
DL021B-10-P	Air Production Drill, Lever Start	156

Index

Model Number	Description	Page	Model Number	Description	Page
DL021B-19-A	Air Production Drill, Lever Start	141, 156	DL052B-6-P	Air Production Drill, Lever Start	157
DL021B-19-B	Air Production Drill, Lever Start	156	DR021B-15-A	Air Production Drill, Lever Start (90° Chuck)	141, 163
DL021B-19-P	Air Production Drill, Lever Start	156	DR021B-15-P	Air Production Drill, Lever Start (90° Chuck)	163
DL021B-220-A	Air Production Drill, Lever Start	141, 156	DR021B-26-A	Air Production Drill, Lever Start (90° Chuck)	163
DL021B-33-A	Air Production Drill, Lever Start	141, 156	DR021B-26-P	Air Production Drill, Lever Start (90° Chuck)	163
DL021B-33-P	Air Production Drill, Lever Start	156	DR021B-50-A	Air Production Drill, Lever Start (90° Chuck)	141, 163
DL021B-5-A	Air Production Drill, Lever Start	156	DR021B-50-P	Air Production Drill, Lever Start (90° Chuck)	163
DL021B-5-B	Air Production Drill, Lever Start	156	DR021B-7-A	Air Production Drill, Lever Start (90° Chuck)	141, 163
DL021B-5-P	Air Production Drill, Lever Start	156	DR021B-7-P	Air Production Drill, Lever Start (90° Chuck)	163
DL021B-64-A	Air Production Drill, Lever Start	141, 156	DR023B-11-E	Air Production Drill, Lever Start (90° Small Angle Head)	141, 163
DL021B-64-P	Air Production Drill, Lever Start	156	DR023B-11-T	Air Production Drill, Lever Start (90° Small Angle Head)	163
DL022B-15-A	Air Production Drill, Lever Start	155	DR023B-21-C	Air Production Drill, Lever Start (90° Small Angle Head)	163
DL022B-15-B	Air Production Drill, Lever Start	155	DR023B-21-E	Air Production Drill, Lever Start (90° Small Angle Head)	163
DL022B-15-P	Air Production Drill, Lever Start	155	DR023B-21-T	Air Production Drill, Lever Start (90° Small Angle Head)	163
DL022B-26-A	Air Production Drill, Lever Start	141, 155	DR023B-37-C	Air Production Drill, Lever Start (90° Small Angle Head)	163
DL022B-26-P	Air Production Drill, Lever Start	155	DR023B-37-E	Air Production Drill, Lever Start (90° Small Angle Head)	163
DL022B-8-A	Air Production Drill, Lever Start	141, 155	DR023B-37-T	Air Production Drill, Lever Start (90° Small Angle Head)	163
DL022B-8-B	Air Production Drill, Lever Start	155	DR023B-5-C	Air Production Drill, Lever Start (90° Small Angle Head)	141, 163
DL022B-8-P	Air Production Drill, Lever Start	155	DR023B-5-E	Air Production Drill, Lever Start (90° Small Angle Head)	163
DL051B-11-B	Air Production Drill, Lever Start	158	DR023B-5-T	Air Production Drill, Lever Start (90° Small Angle Head)	163
DL051B-11-P	Air Production Drill, Lever Start	158	DR051B-11-A	Air Production Drill, Lever Start (90° Chuck)	141, 164
DL051B-15-A	Air Production Drill, Lever Start	141, 158	DR051B-11-B	Air Production Drill, Lever Start (90° Chuck)	164
DL051B-15-B	Air Production Drill, Lever Start	158	DR051B-11-P	Air Production Drill, Lever Start (90° Chuck)	164
DL051B-15-P	Air Production Drill, Lever Start	158	DR051B-19-A	Air Production Drill, Lever Start (90° Chuck)	164
DL051B-180-A	Air Production Drill, Lever Start	158	DR051B-19-B	Air Production Drill, Lever Start (90° Chuck)	164
DL051B-180-P	Air Production Drill, Lever Start	158	DR051B-19-P	Air Production Drill, Lever Start (90° Chuck)	164
DL051B-27-A	Air Production Drill, Lever Start	158	DR051B-28-A	Air Production Drill, Lever Start (90° Chuck)	141, 164
DL051B-27-B	Air Production Drill, Lever Start	158	DR051B-28-B	Air Production Drill, Lever Start (90° Chuck)	164
DL051B-27-P	Air Production Drill, Lever Start	158	DR051B-28-P	Air Production Drill, Lever Start (90° Chuck)	164
DL051B-33-A	Air Production Drill, Lever Start	158	DR051B-36-A	Air Production Drill, Lever Start (90° Chuck)	164
DL051B-33-B	Air Production Drill, Lever Start	158	DR051B-36-B	Air Production Drill, Lever Start (90° Chuck)	164
DL051B-33-P	Air Production Drill, Lever Start	158	DR051B-36-P	Air Production Drill, Lever Start (90° Chuck)	164
DL051B-4-A	Air Production Drill, Lever Start	158	DR051B-4-A	Air Production Drill, Lever Start (90° Chuck)	141, 164
DL051B-4-B	Air Production Drill, Lever Start	158	DR051B-4-B	Air Production Drill, Lever Start (90° Chuck)	164
DL051B-4-P	Air Production Drill, Lever Start	158			
DL051B-52-A	Air Production Drill, Lever Start	158			
DL051B-52-B	Air Production Drill, Lever Start	158			
DL051B-52-P	Air Production Drill, Lever Start	158			
DL051B-6-B	Air Production Drill, Lever Start	158			
DL051B-6-P	Air Production Drill, Lever Start	158			
DL052B-10-B	Air Production Drill, Lever Start	157			
DL052B-10-P	Air Production Drill, Lever Start	157			
DL052B-15-B	Air Production Drill, Lever Start	141, 157			
DL052B-15-P	Air Production Drill, Lever Start	157			
DL052B-25-P	Air Production Drill, Lever Start	157			
DL052B-30-A	Air Production Drill, Lever Start	141, 157			
DL052B-30-B	Air Production Drill, Lever Start	157			
DL052B-30-P	Air Production Drill, Lever Start	157			
DL052B-4-B	Air Production Drill, Lever Start	157			
DL052B-4-P	Air Production Drill, Lever Start	157			
DL052B-6-B	Air Production Drill, Lever Start	141, 157			

Index

Model Number	Description	Page	Model Number	Description	Page
DR051B-4-P	Air Production Drill, Lever Start (90° Chuck)	164	ES100T	AC Screwdriver, Trigger Start with Pistol Attachment	6, 13
DR053B-27-T	Air Production Drill, Lever Start (90° Small Angle Head)	164	ES100T2S3	Large Angle Head Screwdriver, Lever Start	6, 15
DR053B-41-T	Air Production Drill, Lever Start (90° Small Angle Head)	164	ES100T2S5	Large Angle Head Screwdriver, Lever Start	15
DR053B-52-T	Air Production Drill, Lever Start (90° Small Angle Head)	141, 164	ES4007N2S3	Large Angle Head Screwdriver, Lever Start	6, 14
E			ES45T	DC Screwdriver, Inline Lever Start	6, 10
EC24N	Controller	9	ES50T	DC Screwdriver, Inline Lever Start	6, 10
EC24N-ESD	Controller	8	ES50TC	DC Screwdriver, Inline Lever Start, Clean Room	10
ECM24N	Controller	7	ES60P	AC Screwdriver, Inline Push-to-Start	6, 13
EL0109B	DC Screwdriver, Inline Lever Start	6, 9, 17	ES60T	AC Screwdriver, Inline Lever Start	13
EL0410B	DC Screwdriver, Inline Lever Start	6, 9	ES60T1S5	Small Angle Head Screwdriver, Lever Start	15
EL0410BC	DC Screwdriver, Inline Lever Start, Clean Room	9	ES60T2S3	Large Angle Head Screwdriver, Lever Start	6, 15
EL0410BC-SS-ESD	DC Screwdriver, Lever Start Soft Stop	6, 8	ES60T2S5	Large Angle Head Screwdriver, Lever Start	15
EL0510BC-SS-ESD	DC Screwdriver, Lever Start Soft Stop	6, 8	ES70P	AC Screwdriver, Inline Push-to-Start	6, 13
EL0807BC-SS-ESD	DC Screwdriver, Lever Start Soft Stop	6, 8	ES70T	AC Screwdriver, Inline Lever Start	13
EL1007B	DC Screwdriver, Inline Lever Start	6, 8, 9	ES70T1S5	Small Angle Head Screwdriver, Lever Start	6, 15
EL1007BC	DC Screwdriver, Inline Lever Start, Clean Room	9	ES70T2S3	Large Angle Head Screwdriver, Lever Start	6, 15
EL1007BC-ESD	DC Screwdriver, Lever Start	6, 8	ES70T2S5	Large Angle Head Screwdriver, Lever Start	15
EL1007BC-SS-ESD	DC Screwdriver, Lever Start Soft Stop	8	ES80P	AC Screwdriver, Inline Push-to-Start	6, 13
EL1510N	AC Screwdriver, Inline Lever Start	12	ES90P	AC Screwdriver, Inline Push-to-Start	6, 13
EL1510N1S5	Small Angle Head Screwdriver, Lever Start	6, 14	ES90T	AC Screwdriver, Inline Lever Start	13
EL1510N2S3	Large Angle Head Screwdriver, Lever Start	6, 14	ES90T1S5	Small Angle Head Screwdriver, Lever Start	6, 15
EL1510N2S5	Large Angle Head Screwdriver, Lever Start	14	ES90T2S3	Large Angle Head Screwdriver, Lever Start	6, 15
EL1520N	AC Screwdriver, Inline Lever Start	12	ES90T2S5	Large Angle Head Screwdriver, Lever Start	15
EL1520N1S5	Small Angle Head Screwdriver, Lever Start	14	ESCB50	Controller	10
EL2603N	AC Screwdriver, Inline Lever Start	12	ET4007N	AC Screwdriver, Trigger Start with Pistol Attachment	6, 12
EL2607N	AC Screwdriver, Inline Lever Start	12	ETA5	Expert Torque Analyzer	49
EL2612N	AC Screwdriver, Inline Lever Start	12	ETT-12-US	Expert Torque Tester	50
EL2612N1S5	Small Angle Head Screwdriver, Lever Start	6, 14	ETT-1-US	Expert Torque Tester	50
EL2612N2S3	Large Angle Head Screwdriver, Lever Start	6, 14	ETT-30-US	Expert Torque Tester	50
EL2612N2S5	Large Angle Head Screwdriver, Lever Start	14	ETT-4-US	Expert Torque Tester	50
EL4007N2S5	Large Angle Head Screwdriver, Lever Start	14	I		
ELB2612N	AC Screwdriver, Inline Lever Start	11	IC1D1A1AWS	DC Electric Controller	40
ELB2620N	AC Screwdriver, Inline Lever Start	11	IC1D1A1BWS	DC Electric Controller	40
ELM0107N	DC Screwdriver, Inline Lever Start	6, 7	IC1D1A3AWS	DC Electric Controller	40
ELM0110N	DC Screwdriver, Inline Lever Start	6, 7	IC1D1A3BWS	DC Electric Controller	40
ELM0306N	DC Screwdriver, Inline Lever Start	6, 7	IC1D1A4AWS	DC Electric Controller	40
EP1510N	AC Screwdriver, Inline Push-to-Start	6, 12	IC1D1A4BWS	DC Electric Controller	40
EP1520N	AC Screwdriver, Inline Push-to-Start	6, 12	IC1D1A5AWS	DC Electric Controller	40
EP2603N	AC Screwdriver, Inline Push-to-Start	6, 12	IC1D1A5BWS	DC Electric Controller	40
EP2607N	AC Screwdriver, Inline Push-to-Start	6, 12	IC1D1A6AWS	DC Electric Controller	40
EP2612N	AC Screwdriver, Inline Push-to-Start	6, 12	IC1D1A6BWS	DC Electric Controller	40
EP4007N	AC Screwdriver, Push-to-Start with Pistol Attachment	12	IC1D1B1AWS	DC Electric Controller	40
EPB2612N	AC Screwdriver, Inline Push-to-Start	6, 11	IC1D1B1BWS	DC Electric Controller	40
EPB2620N	AC Screwdriver, Inline Push-to-Start	6, 11	IC1D1B3AWS	DC Electric Controller	40
ES100P	AC Screwdriver, Push-to-Start with Pistol Attachment	13	IC1D1B3BWS	DC Electric Controller	40
			IC1D1B4AWS	DC Electric Controller	40
			IC1D1B4BWS	DC Electric Controller	40
			IC1D1B5AWS	DC Electric Controller	40

Index

Model Number	Description	Page	Model Number	Description	Page
IC1D1B5BWS	DC Electric Controller	40	IC1M1B6AWS	DC Electric Controller	40
IC1D1B6AWS	DC Electric Controller	40	IC1M1B6BWS	DC Electric Controller	40
IC1D1B6BWS	DC Electric Controller	40	IC1M2A1AWS	DC Electric Controller	40
IC1D2A1AWS	DC Electric Controller	40	IC1M2A1BWS	DC Electric Controller	40
IC1D2A1BWS	DC Electric Controller	40	IC1M2A3AWS	DC Electric Controller	40
IC1D2A3AWS	DC Electric Controller	40	IC1M2A3BWS	DC Electric Controller	40
IC1D2A3BWS	DC Electric Controller	40	IC1M2A4AWS	DC Electric Controller	40
IC1D2A4AWS	DC Electric Controller	40	IC1M2A4BWS	DC Electric Controller	40
IC1D2A4BWS	DC Electric Controller	40	IC1M2A5AWS	DC Electric Controller	40
IC1D2A5AWS	DC Electric Controller	40	IC1M2A5BWS	DC Electric Controller	40
IC1D2A5BWS	DC Electric Controller	40	IC1M2A6AWS	DC Electric Controller	40
IC1D2A6AWS	DC Electric Controller	40	IC1M2A6BWS	DC Electric Controller	40
IC1D2A6BWS	DC Electric Controller	40	IC1M2B1AWS	DC Electric Controller	40
IC1D2B1AWS	DC Electric Controller	40	IC1M2B1BWS	DC Electric Controller	40
IC1D2B1BWS	DC Electric Controller	40I	IC1M2B3AWS	DC Electric Controller	40
C1D2B3AWS	DC Electric Controller	40	IC1M2B3BWS	DC Electric Controller	40
IC1D2B3BWS	DC Electric Controller	40	IC1M2B4AWS	DC Electric Controller	40
IC1D2B4AWS	DC Electric Controller	40	IC1M2B4BWS	DC Electric Controller	40
IC1D2B4BWS	DC Electric Controller	40	IC1M2B5AWS	DC Electric Controller	40
IC1D2B5AWS	DC Electric Controller	40	IC1M2B5BWS	DC Electric Controller	40
IC1D2B5BWS	DC Electric Controller	40	IC1M2B6AWS	DC Electric Controller	40
IC1D2B6AWS	DC Electric Controller	40	IC1M2B6BWS	DC Electric Controller	40
IC1D2B6BWS	DC Electric Controller	40	IC1M3A1BWS	DC Electric Controller	40
IC1D3A1BWS	DC Electric Controller	40	IC1M3A3BWS	DC Electric Controller	40
IC1D3A3BWS	DC Electric Controller	40	IC1M3A4BWS	DC Electric Controller	40
IC1D3A4BWS	DC Electric Controller	40	IC1M3A5BWS	DC Electric Controller	40
IC1D3A5BWS	DC Electric Controller	40	IC1M3A6BWS	DC Electric Controller	40
IC1D3A6BWS	DC Electric Controller	40	IC1M3B1BWS	DC Electric Controller	40
IC1D3B1BWS	DC Electric Controller	40	IC1M3B3BWS	DC Electric Controller	40
IC1D3B3BWS	DC Electric Controller	40	IC1M3B4BWS	DC Electric Controller	40
IC1D3B4BWS	DC Electric Controller	40	IC1M3B5BWS	DC Electric Controller	40
IC1D3B5BWS	DC Electric Controller	40	IC1M3B6BWS	DC Electric Controller	40
IC1D3B6BWS	DC Electric Controller	40			
IC1M1A1AWS	DC Electric Controller	40	J		
IC1M1A1BWS	DC Electric Controller	40	JKR180	Rotary Transducer Joint Kit	53
IC1M1A3AWS	DC Electric Controller	40	JKR20	Rotary Transducer Joint Kit	53
IC1M1A3BWS	DC Electric Controller	40	JKR500	Rotary Transducer Joint Kit	53
IC1M1A4AWS	DC Electric Controller	40	JKR75	Rotary Transducer Joint Kit	53
IC1M1A4BWS	DC Electric Controller	40	JKS1000	Stationary Transducer Joint Kit	53
IC1M1A5AWS	DC Electric Controller	40	JKS150	Stationary Transducer Joint Kit	53
IC1M1A5BWS	DC Electric Controller	40	JKS30	Stationary Transducer Joint Kit	53
IC1M1A6AWS	DC Electric Controller	40	JKS300	Stationary Transducer Joint Kit	53
IC1M1A6BWS	DC Electric Controller	40	JKST1000	Stationary Transducer with Joint Simulator	53
IC1M1B1AWS	DC Electric Controller	40	JKST150	Stationary Transducer with Joint Simulator	53
IC1M1B1BWS	DC Electric Controller	40	JKST30	Stationary Transducer with Joint Simulator	53
IC1M1B3AWS	DC Electric Controller	40	JKST300	Stationary Transducer with Joint Simulator	53
IC1M1B3BWS	DC Electric Controller	40			
IC1M1B4AWS	DC Electric Controller	40	N		
IC1M1B4BWS	DC Electric Controller	40	NR051B-11H-2	Angle Air Nutrunner, Lever Start	109
IC1M1B5AWS	DC Electric Controller	40	NR051B-16R-2	Angle Air Nutrunner, Lever Start	109
IC1M1B5BWS	DC Electric Controller	40	NR051B-24R-2	Angle Air Nutrunner, Lever Start	109

Index

Model Number	Description	Page	Model Number	Description	Page
NR051B-6H-2	Angle Air Nutrunner, Lever Start	109	QA1739D	Air Production Drill, Lever Start (90° Small Angle Head)	141, 162
NR051B-8H-2	Angle Air Nutrunner, Lever Start	109	QA1L02D6LD	Angle Air Nutrunner, Lever Start	94, 108
NR053B-11H-2	Angle Air Nutrunner, Lever Start	105	QA1L02S1LD	Angle Air Nutrunner, Lever Start	97
NR053B-16R-1	Angle Air Nutrunner, Lever Start	105	QA1L02S1XLD	Angle Air Nutrunner, Lever Start	97
NR053B-6H-2	Angle Air Nutrunner, Lever Start	105	QA1L02S4LD	Angle Air Nutrunner, Lever Start	94, 97
NR053B-8H-2	Angle Air Nutrunner, Lever Start	105	QA1L02S6LD	Angle Air Nutrunner, Lever Start	97
P			QA1L02S6XLD	Angle Air Nutrunner, Lever Start	97
P33006-DMSL	Air Production Drill, Inline/Lever Control	169	QA1L05C1LD	Angle Air Nutrunner, Lever Start	94, 104
P33006-PMSL	Air Production Drill, Pistol Grip/Trigger Start	169	QA1L05C4LD	Angle Air Nutrunner, Lever Start	104
P33011-DMSL	Air Production Drill, Inline/Lever Control	169	QA1L05C6LD	Angle Air Nutrunner, Lever Start	104
P33011-PMSL	Air Production Drill, Pistol Grip/Trigger Start	169	QA1L05D1LD	Angle Air Nutrunner, Lever Start	108
P33016-DMSL	Air Production Drill, Inline/Lever Control	169	QA1L05D4LD	Angle Air Nutrunner, Lever Start	94, 108
P33016-PMSL	Air Production Drill, Pistol Grip/Trigger Start	169	QA1L05D6LD	Angle Air Nutrunner, Lever Start	108
P33022-DMSL	Air Production Drill, Inline/Lever Control	169	QA1L05S1LD	Angle Air Nutrunner, Lever Start	97
P33022-PMSL	Air Production Drill, Pistol Grip/Trigger Start	169	QA1L05S1XLD	Angle Air Nutrunner, Lever Start	97
P33032-DMSL	Air Production Drill, Inline/Lever Control	169	QA1L05S4LD	Angle Air Nutrunner, Lever Start	97
P33032-DMSL-B	Air Production Drill, Inline/Button Control	169	QA1L05S4SD	Angle Air Nutrunner, Lever Start	94, 97
P33032-PMSL	Air Production Drill, Pistol Grip/Trigger Start	169	QA1L05S6LD	Angle Air Nutrunner, Lever Start	97
P33054-DMSL	Air Production Drill, Inline/Lever Control	169	QA1L05S6XLD	Angle Air Nutrunner, Lever Start	97
P33054-DMSL-B	Air Production Drill, Inline/Button Control	169	QA1L05S9LD	Angle Air Nutrunner, Lever Start	97
P33054-PMSL	Air Production Drill, Pistol Grip/Trigger Start	169	QA1L08C1LD	Angle Air Nutrunner, Lever Start	103
Q			QA1L08C4LD	Angle Air Nutrunner, Lever Start	94, 103
Q110P4	Pistol Grip Pulse Tool, Trigger Start	125, 126, 137, 138	QA1L08C9LD	Angle Air Nutrunner, Lever Start	103
Q70P3	Pistol Grip Pulse Tool, Trigger Start	125, 126, 137, 138	QA1L08D1LD	Angle Air Nutrunner, Lever Start	108
Q70PQ1	Pistol Grip Pulse Tool, Trigger Start	125, 126, 137, 138	QA1L08D4LD	Angle Air Nutrunner, Lever Start	94, 108
Q80P3	Pistol Grip Pulse Tool, Trigger Start	125, 126, 137, 138	QA1L08D6LD	Angle Air Nutrunner, Lever Start	108
Q80PQ1	Pistol Grip Pulse Tool, Trigger Start	125, 126, 137, 138	QA1L08S1LD	Angle Air Nutrunner, Lever Start	97
Q90P3	Pistol Grip Pulse Tool, Trigger Start	125, 126, 137, 138	QA1L08S4LD	Angle Air Nutrunner, Lever Start	94, 96
QA0539D	Air Production Drill, Lever Start (90° Small Angle Head)	141, 162	QA1L08S6LD	Angle Air Nutrunner, Lever Start	96
QA0559D	Air Production Drill, Lever Start (90° Small Angle Head)	162	QA1L08S9LD	Angle Air Nutrunner, Lever Start	97
QA0579D	Air Production Drill, Lever Start (90° Small Angle Head)	162	QA1L12C1LD	Angle Air Nutrunner, Lever Start	103
QA0854D	Air Production Drill, Lever Start (45° Small Angle Head)	141, 162	QA1L12C4LD	Angle Air Nutrunner, Lever Start	94, 103
QA0859D	Air Production Drill, Lever Start (90° Small Angle Head)	141, 162	QA1L12C6LD	Angle Air Nutrunner, Lever Start	103
QA1219D	Air Production Drill, Lever Start (90° Chuck)	141, 162	QA1L12C9LD	Angle Air Nutrunner, Lever Start	103
QA1239D	Air Production Drill, Lever Start (90° Small Angle Head)	162	QA1L12D1LD	Angle Air Nutrunner, Lever Start	108
			QA1L12D4LD	Angle Air Nutrunner, Lever Start	94, 108
			QA1L12D6LD	Angle Air Nutrunner, Lever Start	108
			QA1L12S1LD	Angle Air Nutrunner, Lever Start	96
			QA1L12S4LD	Angle Air Nutrunner, Lever Start	94, 96
			QA1L12S4SD	Angle Air Nutrunner, Lever Start	96
			QA1L12S9LD	Angle Air Nutrunner, Lever Start	96
			QA1L18C1LD	Angle Air Nutrunner, Lever Start	103
			QA1L18C4LD	Angle Air Nutrunner, Lever Start	94, 103
			QA1L18S1LD	Angle Air Nutrunner, Lever Start	96
			QA1L18S4LD	Angle Air Nutrunner, Lever Start	94, 96
			QA1L18S4SD	Angle Air Nutrunner, Lever Start	96
			QA1L18S6LD	Angle Air Nutrunner, Lever Start	96
			QA1L18S9LD	Angle Air Nutrunner, Lever Start	96
			QA2119D	Air Production Drill, Lever Start (90° Chuck)	162
			QA2719D	Air Production Drill, Lever Start (90° Chuck)	162

Index

Model Number	Description	Page
QA2739D	Air Production Drill, Lever Start (90° Small Angle Head)	162
QA2754D	Air Production Drill, Lever Start (45° Small Angle Head)	162
QA2755D	Air Production Drill, Lever Start (90° x 90° Small Angle Head)	162
QA2759D	Air Production Drill, Lever Start (90° Small Angle Head)	162
QA3555D	Air Production Drill, Lever Start (90° x 90° Small Angle Head)	162
QA3559D	Air Production Drill, Lever Start (90° Small Angle Head)	141, 162
QA4AALD011NP25S06	Angle Air Nutrunner, Lever Start	112
QA4AALD015NP25S06	Angle Air Nutrunner, Lever Start	112
QA4AALD020NP25S06	Angle Air Nutrunner, Lever Start	112
QA4AALD030NP28S06	Angle Air Nutrunner, Lever Start	112
QA4AALD040NP35S06	Angle Air Nutrunner, Lever Start	112
QA4AALD055NP35S08	Angle Air Nutrunner, Lever Start	112
QA4AALS011NP25S06	Angle Air Nutrunner, Lever Start	100
QA4AALS015NP25S06	Angle Air Nutrunner, Lever Start	100
QA4AALS020NP25S06	Angle Air Nutrunner, Lever Start	94, 100
QA4AALS020NP28S06	Angle Air Nutrunner, Lever Start	100
QA4AALS030NP28S06	Angle Air Nutrunner, Lever Start	94, 100
QA4AALS040NP35S06	Angle Air Nutrunner, Lever Start	100
QA4AALS040NP35S08	Angle Air Nutrunner, Lever Start	100
QA4AALS055NP35S08	Angle Air Nutrunner, Lever Start	100
QA4ASLS012NP41S06	Inline Air Nutrunner, Lever Start	115, 116
QA4ASLS015NP41S06	Inline Air Nutrunner, Lever Start	115, 116
QA4ASLS020NP41S06	Inline Air Nutrunner, Lever Start	115, 116
QA4ASLS027NP41S06	Inline Air Nutrunner, Lever Start	115, 116
QA4ASLS046NP41S06	Inline Air Nutrunner, Lever Start	115, 116
QA4ASLS046NP41S08	Inline Air Nutrunner, Lever Start	116
QA4ASR012NF41S06	Inline Air Nutrunner, Remote Start	115, 119
QA4ASR015NF41S06	Inline Air Nutrunner, Remote Start	115, 119
QA4ASR020NF41S06	Inline Air Nutrunner, Remote Start	115, 119
QA4ASR027NF41S06	Inline Air Nutrunner, Remote Start	115, 119
QA4ASR046NF41S06	Inline Air Nutrunner, Remote Start	115, 119
QA4ASRD012NF41S06	Inline Air Nutrunner, Remote Start	115, 122
QA4ASRD015NF41S06	Inline Air Nutrunner, Remote Start	115, 122
QA4ASRD020NF41S06	Inline Air Nutrunner, Remote Start	115, 122
QA4ASRD027NF41S06	Inline Air Nutrunner, Remote Start	115, 122
QA4ASRD046NF41S06	Inline Air Nutrunner, Remote Start	115, 122
QA4ASRD046NF41S08	Inline Air Nutrunner, Remote Start	122
QA4ASRS046NF41S08	Inline Air Nutrunner, Remote Start	119
QA6AALD030NP35S06	Angle Air Nutrunner, Lever Start	113
QA6AALD040NP35S06	Angle Air Nutrunner, Lever Start	113
QA6AALD040NP35S08	Angle Air Nutrunner, Lever Start	113
QA6AALD055NP35S08	Angle Air Nutrunner, Lever Start	113
QA6AALD070NP43S08	Angle Air Nutrunner, Lever Start	113
QA6AALD090NP43S08	Angle Air Nutrunner, Lever Start	113
QA6AALS030NP35S06	Angle Air Nutrunner, Lever Start	101

Model Number	Description	Page
QA6AALS040NP35S06	Angle Air Nutrunner, Lever Start	94, 101
QA6AALS040NP35S08	Angle Air Nutrunner, Lever Start	101
QA6AALS055NP35S08	Angle Air Nutrunner, Lever Start	101
QA6AALS070NP35S06	Angle Air Nutrunner, Lever Start	94
QA6AALS070NP43S08	Angle Air Nutrunner, Lever Start	101
QA6AALS090NP43S08	Angle Air Nutrunner, Lever Start	101
QA6ASLS025NP41S06	Inline Air Nutrunner, Lever Start	115, 117
QA6ASLS030NP41S06	Inline Air Nutrunner, Lever Start	115, 117
QA6ASLS040NP41S06	Inline Air Nutrunner, Lever Start	115, 117
QA6ASLS055NP41S08	Inline Air Nutrunner, Lever Start	115, 117
QA6ASR025NF41S06	Inline Air Nutrunner, Remote Start	115, 120
QA6ASR030NF41S06	Inline Air Nutrunner, Remote Start	115, 120
QA6ASR040NF41S06	Inline Air Nutrunner, Remote Start	115, 120
QA6ASR055NF41S06	Inline Air Nutrunner, Remote Start	115, 120
QA6ASRD025NF41S06	Inline Air Nutrunner, Remote Start	115, 123
QA6ASRD030NF41S06	Inline Air Nutrunner, Remote Start	115, 123
QA6ASRD040NF41S06	Inline Air Nutrunner, Remote Start	115, 123
QA6ASRD055NF41S08	Inline Air Nutrunner, Remote Start	115, 123
QA8AALD040NP35S06	Angle Air Nutrunner, Lever Start	114
QA8AALD040NP35S08	Angle Air Nutrunner, Lever Start	114
QA8AALD055NP35S08	Angle Air Nutrunner, Lever Start	114
QA8AALD070NP43S08	Angle Air Nutrunner, Lever Start	114
QA8AALD090NP43S08	Angle Air Nutrunner, Lever Start	114
QA8AALD115NP48S08	Angle Air Nutrunner, Lever Start	114
QA8AALD150NP48S08	Angle Air Nutrunner, Lever Start	114
QA8AALD200NF56S12	Angle Air Nutrunner, Lever Start	114
QA8AALD225NF56S12	Angle Air Nutrunner, Lever Start	114
QA8AALS040NP35S06	Angle Air Nutrunner, Lever Start	102
QA8AALS040NP35S08	Angle Air Nutrunner, Lever Start	102
QA8AALS055NP35S08	Angle Air Nutrunner, Lever Start	102
QA8AALS070NP43S08	Angle Air Nutrunner, Lever Start	94, 102
QA8AALS090NP43S08	Angle Air Nutrunner, Lever Start	94, 102
QA8AALS115NP48S08	Angle Air Nutrunner, Lever Start	102
QA8AALS150NP48S08	Angle Air Nutrunner, Lever Start	102
QA8AALS200NF56S12	Angle Air Nutrunner, Lever Start	102
QA8AALS225NF56S12	Angle Air Nutrunner, Lever Start	102
QA8ASLS040NP41S06	Inline Air Nutrunner, Lever Start	118
QA8ASLS040NP41S08	Inline Air Nutrunner, Lever Start	115, 118
QA8ASLS055NP41S08	Inline Air Nutrunner, Lever Start	115, 118
QA8ASLS070NP41S08	Inline Air Nutrunner, Lever Start	115, 118
QA8ASLS090NP41S08	Inline Air Nutrunner, Lever Start	115, 118
QA8ASLS115NP41S08	Inline Air Nutrunner, Lever Start	115, 118
QA8ASLS150NP41S08	Inline Air Nutrunner, Lever Start	115, 118
QA8ASLS180NP41S08	Inline Air Nutrunner, Lever Start	115, 118
QA8ASR040NF41S06	Inline Air Nutrunner, Remote Start	115, 121
QA8ASR055NF41S08	Inline Air Nutrunner, Remote Start	115, 121
QA8ASR070NF41S08	Inline Air Nutrunner, Remote Start	115, 121
QA8ASR090NF41S08	Inline Air Nutrunner, Remote Start	115, 121
QA8ASR115NF41S08	Inline Air Nutrunner, Remote Start	115, 121
QA8ASR150NF41S08	Inline Air Nutrunner, Remote Start	115, 121
QA8ASR180NF41S08	Inline Air Nutrunner, Remote Start	115, 121

Index

Model Number	Description	Page
QA8ASRD040NF41S06	... Inline Air Nutrunner, Remote Start	115, 124
QA8ASRD040NF41S08	... Inline Air Nutrunner, Remote Start	124
QA8ASRD055NF41S08	... Inline Air Nutrunner, Remote Start	115, 124
QA8ASRD070NF41S08	... Inline Air Nutrunner, Remote Start	115, 124
QA8ASRD090NF41S08	... Inline Air Nutrunner, Remote Start	115, 124
QA8ASRD115NF41S08	... Inline Air Nutrunner, Remote Start	115, 124
QA8ASRD150NF41S08	... Inline Air Nutrunner, Remote Start	115, 124
QA8ASRD180NF41S08	... Inline Air Nutrunner, Remote Start	115, 124
QA8ASRS040NF41S08	... Inline Air Nutrunner, Remote Start	121
QC100-N-K	... Air Tool Qualifier, for Use w/ Non-Shut-off Tools	132
QC100-S-K	... Air Tool Qualifier, for Use w/ Non-Shut-off Tools	132
QC200-N-K	... Air Tool Qualifier, for Use w/ Shut-off Tools	132
QC200-S-K	... Air Tool Qualifier, for Use w/ Shut-off Tools	132
QE4AT013PA2H04	... DC Electric Nutrunner, Angle	28
QE4AT013PA2Q04	... DC Electric Nutrunner, Angle	28
QE4AT013PA2S04	... DC Electric Nutrunner, Angle	28
QE4AT013PA2S06	... DC Electric Nutrunner, Angle	28
QE4AT020PA2H04	... DC Electric Nutrunner, Angle	28
QE4AT020PA2Q04	... DC Electric Nutrunner, Angle	28
QE4AT020PA2S04	... DC Electric Nutrunner, Angle	28
QE4AT020PA2S06	... DC Electric Nutrunner, Angle	28
QE4AT027PA4S06	... DC Electric Nutrunner, Angle	28
QE4AT027PA4S08	... DC Electric Nutrunner, Angle	28
QE4AT034PA4S06	... DC Electric Nutrunner, Angle	28
QE4AT034PA4S08	... DC Electric Nutrunner, Angle	28
QE4PP010P11Q04	... DC Electric Nutrunner, Trigger + Push-to-Start	20
QE4PP010P11S04	... DC Electric Nutrunner, Trigger + Push-to-Start	20
QE4PP010P11S06	... DC Electric Nutrunner, Trigger + Push-to-Start	20
QE4PP015P11Q04	... DC Electric Nutrunner, Trigger + Push-to-Start	20
QE4PP015P11S04	... DC Electric Nutrunner, Trigger + Push-to-Start	20
QE4PP015P11S06	... DC Electric Nutrunner, Trigger + Push-to-Start	20
QE4PP020P11S06	... DC Electric Nutrunner, Trigger + Push-to-Start	20
QE4PP025P11S06	... DC Electric Nutrunner, Trigger + Push-to-Start	20
QE4PS010P11Q04	... DC Electric Nutrunner, Push-to-Start	21
QE4PS010P11S04	... DC Electric Nutrunner, Push-to-Start	21
QE4PS010P11S06	... DC Electric Nutrunner, Push-to-Start	21
QE4PS015P11Q04	... DC Electric Nutrunner, Push-to-Start	21
QE4PS015P11S04	... DC Electric Nutrunner, Push-to-Start	21
QE4PS015P11S06	... DC Electric Nutrunner, Push-to-Start	21
QE4PS020P11S06	... DC Electric Nutrunner, Push-to-Start	21
QE4PS025P11S06	... DC Electric Nutrunner, Push-to-Start	21
QE4PT010P10Q04	... DC Electric Nutrunner, Trigger Start	21
QE4PT010P10S04	... DC Electric Nutrunner, Trigger Start	21
QE4PT010P10S06	... DC Electric Nutrunner, Trigger Start	21
QE4PT015P10Q04	... DC Electric Nutrunner, Trigger Start	21
QE4PT015P10S04	... DC Electric Nutrunner, Trigger Start	21
QE4PT015P10S06	... DC Electric Nutrunner, Trigger Start	21
QE4PT020P10S06	... DC Electric Nutrunner, Trigger Start	21
QE4PT025P10S06	... DC Electric Nutrunner, Trigger Start	21

Model Number	Description	Page
QE4ST010B20Q04	... DC Electric Nutrunner, Inline	22
QE4ST010B20S04	... DC Electric Nutrunner, Inline	22
QE4ST010B20S06	... DC Electric Nutrunner, Inline	22
QE4ST010B21Q04	... DC Electric Nutrunner, Inline	22
QE4ST010B21S04	... DC Electric Nutrunner, Inline	22
QE4ST010B21S06	... DC Electric Nutrunner, Inline	22
QE4ST010B21S08	... DC Electric Nutrunner, Inline	22
QE4ST010B41Q04	... DC Electric Nutrunner, Inline	22
QE4ST010B41S04	... DC Electric Nutrunner, Inline	22
QE4ST010B41S06	... DC Electric Nutrunner, Inline	22
QE4ST010B41S08	... DC Electric Nutrunner, Inline	22
QE4ST015B20Q04	... DC Electric Nutrunner, Inline	22
QE4ST015B20S04	... DC Electric Nutrunner, Inline	22
QE4ST015B20S06	... DC Electric Nutrunner, Inline	22
QE4ST015B21Q04	... DC Electric Nutrunner, Inline	23
QE4ST015B21S04	... DC Electric Nutrunner, Inline	23
QE4ST015B21S06	... DC Electric Nutrunner, Inline	23
QE4ST015B21S08	... DC Electric Nutrunner, Inline	23
QE4ST015B41Q04	... DC Electric Nutrunner, Inline	23
QE4ST015B41S04	... DC Electric Nutrunner, Inline	23
QE4ST015B41S06	... DC Electric Nutrunner, Inline	23
QE4ST015B41S08	... DC Electric Nutrunner, Inline	23
QE4ST020B20Q04	... DC Electric Nutrunner, Inline	23
QE4ST020B20S04	... DC Electric Nutrunner, Inline	23
QE4ST020B20S06	... DC Electric Nutrunner, Inline	23
QE4ST020B21Q04	... DC Electric Nutrunner, Inline	23
QE4ST020B21S04	... DC Electric Nutrunner, Inline	23
QE4ST020B21S06	... DC Electric Nutrunner, Inline	23
QE4ST020B21S08	... DC Electric Nutrunner, Inline	23
QE4ST020B41Q04	... DC Electric Nutrunner, Inline	23
QE4ST020B41S04	... DC Electric Nutrunner, Inline	23
QE4ST020B41S06	... DC Electric Nutrunner, Inline	23
QE4ST020B41S08	... DC Electric Nutrunner, Inline	23
QE4ST025B20Q04	... DC Electric Nutrunner, Inline	23
QE4ST025B20S04	... DC Electric Nutrunner, Inline	23
QE4ST025B21Q04	... DC Electric Nutrunner, Inline	23
QE4ST025B21S04	... DC Electric Nutrunner, Inline	23
QE4ST025B21S06	... DC Electric Nutrunner, Inline	23
QE4ST025B21S08	... DC Electric Nutrunner, Inline	23
QE4ST025B41Q04	... DC Electric Nutrunner, Inline	23
QE4ST025B41S04	... DC Electric Nutrunner, Inline	23
QE4ST025B41S06	... DC Electric Nutrunner, Inline	23
QE4ST025B41S08	... DC Electric Nutrunner, Inline	23
QE4TS010R11Q04	... DC Electric Nutrunner, Inline Push-to-Start	19
QE4TS010R11S04	... DC Electric Nutrunner, Inline Push-to-Start	19
QE4TS010R11S06	... DC Electric Nutrunner, Inline Push-to-Start	19
QE4TS015R11Q04	... DC Electric Nutrunner, Inline Push-to-Start	19
QE4TS015R11S04	... DC Electric Nutrunner, Inline Push-to-Start	19
QE4TS015R11S06	... DC Electric Nutrunner, Inline Push-to-Start	19
QE4TS020R11S06	... DC Electric Nutrunner, Inline Push-to-Start	19

Index

Model Number	Description	Page	Model Number	Description	Page
QE4TS025R11S06	DC Electric Nutrunner, Inline Push-to-Start	19	QE8AT225PA7S12	DC Electric Nutrunner, Angle	29
QE6AT030PA2S06	DC Electric Nutrunner, Angle	29	QE8AT400FA8S12	DC Electric Nutrunner, Angle	29
QE6AT030PA4S06	DC Electric Nutrunner, Angle	29	QE8ST055F41S08	DC Electric Nutrunner, Inline	25
QE6AT030PA4S08	DC Electric Nutrunner, Angle	29	QE8ST055F61S08	DC Electric Nutrunner, Inline	25
QE6AT040PA4S06	DC Electric Nutrunner, Angle	29	QE8ST055F81S08	DC Electric Nutrunner, Inline	25
QE6AT040PA4S08	DC Electric Nutrunner, Angle	29	QE8ST070F41S08	DC Electric Nutrunner, Inline	25
QE6AT055PA5S08	DC Electric Nutrunner, Angle	29	QE8ST070F61S08	DC Electric Nutrunner, Inline	25
QE6AT080PA5S08	DC Electric Nutrunner, Angle	29	QE8ST070F81S08	DC Electric Nutrunner, Inline	25
QE6ST020F41S06	DC Electric Nutrunner, Inline	24	QE8ST090F41S08	DC Electric Nutrunner, Inline	25
QE6ST020F41S08	DC Electric Nutrunner, Inline	24	QE8ST090F61S08	DC Electric Nutrunner, Inline	25
QE6ST020F61S06	DC Electric Nutrunner, Inline	24	QE8ST090F81S08	DC Electric Nutrunner, Inline	25
QE6ST020F61S08	DC Electric Nutrunner, Inline	24	QE8ST150F41S08	DC Electric Nutrunner, Inline	25
QE6ST020F81S06	DC Electric Nutrunner, Inline	24	QE8ST150F61S08	DC Electric Nutrunner, Inline	25
QE6ST020F81S08	DC Electric Nutrunner, Inline	24	QE8ST150F81S08	DC Electric Nutrunner, Inline	25
QE6ST028F41S06	DC Electric Nutrunner, Inline	24	QE8ST230F02S12	DC Electric Nutrunner, Inline	25
QE6ST028F41S08	DC Electric Nutrunner, Inline	24	QE8ST230F22S12	DC Electric Nutrunner, Inline	25
QE6ST028F61S06	DC Electric Nutrunner, Inline	24	QE8ST230F62S12	DC Electric Nutrunner, Inline	25
QE6ST028F61S08	DC Electric Nutrunner, Inline	24	QE8ST230F82S12	DC Electric Nutrunner, Inline	25
QE6ST028F81S06	DC Electric Nutrunner, Inline	24	QE8ZC055F52S06	DC Electric Nutrunner, Inline Offset	27
QE6ST028F81S08	DC Electric Nutrunner, Inline	24	QE8ZC070F02S08	DC Electric Nutrunner, Inline Offset	27
QE6ST033F41S06	DC Electric Nutrunner, Inline	24	QE8ZC070F02S12	DC Electric Nutrunner, Inline Offset	27
QE6ST033F41S08	DC Electric Nutrunner, Inline	24	QE8ZC070F22S08	DC Electric Nutrunner, Inline Offset	27
QE6ST033F61S06	DC Electric Nutrunner, Inline	24	QE8ZC070F22S12	DC Electric Nutrunner, Inline Offset	27
QE6ST033F61S08	DC Electric Nutrunner, Inline	24	QE8ZC070F62S08	DC Electric Nutrunner, Inline Offset	27
QE6ST033F81S06	DC Electric Nutrunner, Inline	24	QE8ZC070F62S12	DC Electric Nutrunner, Inline Offset	27
QE6ST033F81S08	DC Electric Nutrunner, Inline	24	QE8ZC070F82S08	DC Electric Nutrunner, Inline Offset	27
QE6ST050F41S08	DC Electric Nutrunner, Inline	24	QE8ZC070F82S12	DC Electric Nutrunner, Inline Offset	27
QE6ST050F61S08	DC Electric Nutrunner, Inline	24	QE8ZC090F02S08	DC Electric Nutrunner, Inline Offset	27
QE6ST050F81S08	DC Electric Nutrunner, Inline	24	QE8ZC090F02S12	DC Electric Nutrunner, Inline Offset	27
QE6ZC020P42S06	DC Electric Nutrunner, Inline Offset	26	QE8ZC090F22S08	DC Electric Nutrunner, Inline Offset	27
QE6ZC020P52S06	DC Electric Nutrunner, Inline Offset	26	QE8ZC090F22S12	DC Electric Nutrunner, Inline Offset	27
QE6ZC028P52S06	DC Electric Nutrunner, Inline Offset	26	QE8ZC090F62S08	DC Electric Nutrunner, Inline Offset	27
QE6ZC033P52S06	DC Electric Nutrunner, Inline Offset	26	QE8ZC090F62S12	DC Electric Nutrunner, Inline Offset	27
QE6ZC050P52S06	DC Electric Nutrunner, Inline Offset	26	QE8ZC090F82S08	DC Electric Nutrunner, Inline Offset	27
QE8AT065FA5S08	DC Electric Nutrunner, Angle	29	QE8ZC090F82S12	DC Electric Nutrunner, Inline Offset	27
QE8AT065FA6S08	DC Electric Nutrunner, Angle	29	QE8ZC150F02S08	DC Electric Nutrunner, Inline Offset	27
QE8AT065PA5S08	DC Electric Nutrunner, Angle	29	QE8ZC150F02S12	DC Electric Nutrunner, Inline Offset	27
QE8AT065PA6S08	DC Electric Nutrunner, Angle	29	QE8ZC150F22S08	DC Electric Nutrunner, Inline Offset	27
QE8AT070FA5S08	DC Electric Nutrunner, Angle	29	QE8ZC150F22S12	DC Electric Nutrunner, Inline Offset	27
QE8AT070FA6S08	DC Electric Nutrunner, Angle	29	QE8ZC150F62S08	DC Electric Nutrunner, Inline Offset	27
QE8AT070PA5S08	DC Electric Nutrunner, Angle	29	QE8ZC150F62S12	DC Electric Nutrunner, Inline Offset	27
QE8AT070PA6S08	DC Electric Nutrunner, Angle	29	QE8ZC150F82S08	DC Electric Nutrunner, Inline Offset	27
QE8AT090FA5S08	DC Electric Nutrunner, Angle	29	QE8ZC150F82S12	DC Electric Nutrunner, Inline Offset	27
QE8AT090FA6S08	DC Electric Nutrunner, Angle	29	QM3SS008H22S06	DC Electric Fixtured Spindle, Inline	31
QE8AT090PA5S08	DC Electric Nutrunner, Angle	29	QM3SS008H22S08	DC Electric Fixtured Spindle, Inline	31
QE8AT090PA6S08	DC Electric Nutrunner, Angle	29	QM3SS008H62S06	DC Electric Fixtured Spindle, Inline	31
QE8AT115FA6S08	DC Electric Nutrunner, Angle	29	QM3SS008H62S08	DC Electric Fixtured Spindle, Inline	31
QE8AT115PA6S08	DC Electric Nutrunner, Angle	29	QM3SS008H92S06	DC Electric Fixtured Spindle, Inline	31
QE8AT150FA6S08	DC Electric Nutrunner, Angle	29	QM3SS008H92S08	DC Electric Fixtured Spindle, Inline	31
QE8AT150PA6S08	DC Electric Nutrunner, Angle	29	QM3SS012H22S06	DC Electric Fixtured Spindle, Inline	31
QE8AT225FA7S12	DC Electric Nutrunner, Angle	29	QM3SS012H22S08	DC Electric Fixtured Spindle, Inline	31

Index

Model Number	Description	Page	Model Number	Description	Page
QM9ZS450H92S12	DC Electric Fixtured Spindle, Offset	35	QP1T10C1TD	Pistol Grip Air Screwdriver, Trigger + Push-to-Start	65
QM9ZS450H92S16	DC Electric Fixtured Spindle, Offset	35	QP1T10S1D	Pistol Grip Air Screwdriver, Trigger + Push-to-Start	55, 58
QP051D	Air Production Drill, Trigger Start	140, 143	QP1T10S1TD	Pistol Grip Air Screwdriver, Trigger + Push-to-Start	58
QP052D	Air Production Drill, Trigger Start	140, 143	QP1T10S3D	Pistol Grip Air Screwdriver, Trigger + Push-to-Start	58
QP091D	Air Production Drill, Trigger Start	140, 143	QP1T20S1D	Pistol Grip Air Screwdriver, Trigger + Push-to-Start	55, 58
QP151D	Air Production Drill, Trigger Start	140, 143	QP1T20S1TD	Pistol Grip Air Screwdriver, Trigger + Push-to-Start	58
QP152D	Air Production Drill, Trigger Start	140, 143	QP201D	Air Production Drill, Trigger Start	140, 143
QP1P02S1TD	Pistol Grip Air Screwdriver, Push-to-Start	57	QP202D	Air Production Drill, Trigger Start	140, 143
QP1P05C1D	Pistol Grip Air Screwdriver, Push-to-Start	65	QP301LD	Air Production Drill, Trigger Start	140, 143
QP1P05S1D	Pistol Grip Air Screwdriver, Push-to-Start	57	QP302LD	Air Production Drill, Trigger Start	140, 143
QP1P05S1TD	Pistol Grip Air Screwdriver, Push-to-Start	57	QP381D	Air Production Drill, Trigger Start	140, 143
QP1P10C1D	Pistol Grip Air Screwdriver, Push-to-Start	65	QP511LD	Air Production Drill, Trigger Start	140, 143
QP1P10S1D	Pistol Grip Air Screwdriver, Push-to-Start	57	QS151D	Air Production Drill, Lever Start	141, 154
QP1P10S1TD	Pistol Grip Air Screwdriver, Push-to-Start	57	QS1L02S1D	Inline Air Screwdriver, Lever Start	80
QP1P20C1D	Pistol Grip Air Screwdriver, Push-to-Start	55, 65	QS1L05C1D	Inline Air Screwdriver, Lever Start	78, 85
QP1P20S1D	Pistol Grip Air Screwdriver, Push-to-Start	57	QS1L05S1D	Inline Air Screwdriver, Lever Start	80
QP1S02C1TD	Pistol Grip Air Screwdriver, Trigger Start	65	QS1L10C1D	Inline Air Screwdriver, Lever Start	78, 85
QP1S02S1TD	Pistol Grip Air Screwdriver, Trigger Start	58	QS1L10C3D	Inline Air Screwdriver, Lever Start	85
QP1S05C1D	Pistol Grip Air Screwdriver, Trigger Start	55, 65	QS1L10D1D	Inline Air Screwdriver, Lever Start	78, 92
QP1S05C1TD	Pistol Grip Air Screwdriver, Trigger Start	65	QS1L10S1D	Inline Air Screwdriver, Lever Start	80
QP1S05D1D	Pistol Grip Air Screwdriver, Trigger Start	55, 73	QS1L15C1D	Inline Air Screwdriver, Lever Start	78, 85
QP1S05D1TD	Pistol Grip Air Screwdriver, Trigger Start	73	QS1L15S1D	Inline Air Screwdriver, Lever Start	80
QP1S05D8D	Tapper, Trigger Start	172	QS1L20C1D	Inline Air Screwdriver, Lever Start	78, 85
QP1S05S1D	Pistol Grip Air Screwdriver, Trigger Start	58	QS1L20D1D	Inline Air Screwdriver, Lever Start	78, 92
QP1S05S1TD	Pistol Grip Air Screwdriver, Trigger Start	58	QS1L20S1D	Inline Air Screwdriver, Lever Start	80
QP1S10C1D	Pistol Grip Air Screwdriver, Trigger Start	65	QS1L28C1D	Inline Air Screwdriver, Lever Start	78, 85
QP1S10C1TD	Pistol Grip Air Screwdriver, Trigger Start	65	QS1L28D1D	Inline Air Screwdriver, Lever Start	78, 92
QP1S10D1D	Pistol Grip Air Screwdriver, Trigger Start	55, 73	QS1P02S1D	Inline Air Screwdriver, Push-to-Start	80
QP1S10D1TD	Pistol Grip Air Screwdriver, Trigger Start	73	QS1P05C1D	Inline Air Screwdriver, Push-to-Start	85
QP1S10D8D	Tapper, Trigger Start	172	QS1P05S1D	Inline Air Screwdriver, Push-to-Start	80
QP1S10S1D	Pistol Grip Air Screwdriver, Trigger Start	58	QS1P05S3D	Inline Air Screwdriver, Push-to-Start	80
QP1S10S1TD	Pistol Grip Air Screwdriver, Trigger Start	58	QS1P10C1D	Inline Air Screwdriver, Push-to-Start	85
QP1S15D1D	Pistol Grip Air Screwdriver, Trigger Start	73	QS1P10S1D	Inline Air Screwdriver, Push-to-Start	80
QP1S15D1TD	Pistol Grip Air Screwdriver, Trigger Start	73	QS1P10S3D	Inline Air Screwdriver, Push-to-Start	80
QP1S20D1D	Pistol Grip Air Screwdriver, Trigger Start	55, 73	QS1P15C1D	Inline Air Screwdriver, Push-to-Start	85
QP1S20D1TD	Pistol Grip Air Screwdriver, Trigger Start	73	QS1P15S1D	Inline Air Screwdriver, Push-to-Start	80
QP1S20S1D	Pistol Grip Air Screwdriver, Trigger Start	58	QS1P15S3D	Inline Air Screwdriver, Push-to-Start	80
QP1S20S1TD	Pistol Grip Air Screwdriver, Trigger Start	58	QS1P20C1D	Inline Air Screwdriver, Push-to-Start	85
QP1T02S1D	Pistol Grip Air Screwdriver, Trigger + Push-to-Start	55, 58	QS1P20S1D	Inline Air Screwdriver, Push-to-Start	80
QP1T02S1TD	Pistol Grip Air Screwdriver, Trigger + Push-to-Start	58	QS1P28C1D	Inline Air Screwdriver, Push-to-Start	85
QP1T05S1D	Pistol Grip Air Screwdriver, Trigger + Push-to-Start	58	QS1T02S1D	Inline Air Screwdriver, Lever + Push-to-Start	81
QP1T05S1TD	Pistol Grip Air Screwdriver, Trigger + Push-to-Start	58	QS1T05S1D	Inline Air Screwdriver, Lever + Push-to-Start	78, 81
QP1T05S3D	Pistol Grip Air Screwdriver, Trigger + Push-to-Start	58	QS1T10S1D	Inline Air Screwdriver, Lever + Push-to-Start	78, 80
QP1T10C1D	Pistol Grip Air Screwdriver, Trigger + Push-to-Start	65			

Index

Model Number	Description	Page	Model Number	Description	Page
QS1T15S1D	Inline Air Screwdriver, Lever + Push-to-Start	78, 81	SG023B-15-Q	Pistol Grip Air Screwdriver, Trigger Start	55, 64
QS1T20S1D	Inline Air Screwdriver, Lever + Push-to-Start	78, 81	SG023B-26-Q	Pistol Grip Air Screwdriver, Trigger Start	55, 64
QS301D	Air Production Drill, Lever Start	141, 154	SG023B-9-Q	Pistol Grip Air Screwdriver, Trigger Start	55, 64
QS381D	Air Production Drill, Lever Start	141, 154	SG051B-10-Q	Pistol Grip Air Screwdriver, Trigger Start	74
QS511D	Air Production Drill, Lever Start	141, 154	SG051B-17-Q	Pistol Grip Air Screwdriver, Trigger Start	74
QTA010	Torque Reaction Arm	180, 181	SG051B-25-Q	Pistol Grip Air Screwdriver, Trigger Start	74
QTA020	Torque Reaction Arm	180, 181	SG051B-8-Q	Pistol Grip Air Screwdriver, Trigger Start	74
QTA040	Torque Reaction Arm	180, 181	SG052B-10-Q	Pistol Grip Air Screwdriver, Angle Jaw Trigger Start	69
QTA100	Torque Reaction Arm	180, 181	SG052B-17-Q	Pistol Grip Air Screwdriver, Angle Jaw Trigger Start	69
QTA150	Torque Reaction Arm	180, 181	SG052B-25-Q	Pistol Grip Air Screwdriver, Angle Jaw Trigger Start	69
QTA270	Torque Reaction Arm	180, 181	SG052B-8-Q	Pistol Grip Air Screwdriver, Angle Jaw Trigger Start	69
QTA475	Torque Reaction Arm	180, 181	SG053B-10-Q	Pistol Grip Air Screwdriver, Trigger Start	64
QXLH-13-14	Hose Light	138	SG053B-17-Q	Pistol Grip Air Screwdriver, Trigger Start	64
QXLH-16-14	Hose Light	138	SG053B-25-Q	Pistol Grip Air Screwdriver, Trigger Start	64
QXLH-16-38	Hose Light	138	SG053B-8-Q	Pistol Grip Air Screwdriver, Trigger Start	64
QXLH-25-14	Hose Light	138	SG059B-10-Q	Pistol Grip Air Screwdriver, 90 Degree Jaw Trigger Start	69
QXLH-25-38	Hose Light	138	SG059B-17-Q	Pistol Grip Air Screwdriver, 90 Degree Jaw Trigger Start	69
QXP110P8	Pistol Grip Pulse Tool, Trigger Start	125, 133, 138	SG059B-8-Q	Pistol Grip Air Screwdriver, 90 Degree Jaw Trigger Start	69
QXP120P8	Pistol Grip Pulse Tool, Trigger Start	125, 133, 138	SL021B-15-Q	Inline Air Screwdriver, Lever Start	78, 91
QXP140P8	Pistol Grip Pulse Tool, Trigger Start	125, 133, 138	SL021B-26-Q	Inline Air Screwdriver, Lever Start	78, 91
QXP150P8	Pistol Grip Pulse Tool, Trigger Start	125, 133	SL021B-9-Q	Inline Air Screwdriver, Lever Start	78, 91
QXP60P6	Pistol Grip Pulse Tool, Trigger Start	125, 133	SL022B-15-Q	Inline Air Screwdriver, Angle Jaw	78, 89
QXP60Q4	Pistol Grip Pulse Tool, Trigger Start	133	SL022B-9-Q	Inline Air Screwdriver, Angle Jaw	78, 89
QXP70P6	Pistol Grip Pulse Tool, Trigger Start	125, 133, 138	SL023B-15-Q	Inline Air Screwdriver, Lever Start	78, 86
QXP70Q4	Pistol Grip Pulse Tool, Trigger Start	133, 138	SL023B-26-Q	Inline Air Screwdriver, Lever Start	78, 86
QXP80P6	Pistol Grip Pulse Tool, Trigger Start	125, 133	SL023B-9-Q	Inline Air Screwdriver, Lever Start	78, 86
QXP90P6	Pistol Grip Pulse Tool, Trigger Start	125, 133, 138	SL051B-10-Q	Inline Air Screwdriver, Lever Start	91
S			SL051B-17-Q	Inline Air Screwdriver, Lever Start	91
SA023B-15-Q	Inline Air Screwdriver, Push-to-Start	86	SL051B-25-Q	Inline Air Screwdriver, Lever Start	91
SA023B-26-Q	Inline Air Screwdriver, Push-to-Start	86	SL051B-8-Q	Inline Air Screwdriver, Lever Start	91
SA023B-9-Q	Inline Air Screwdriver, Push-to-Start	86	SL052B-10-Q	Inline Air Screwdriver, Angle Jaw	89
SA024C-15-Q	Inline Air Screwdriver, Push-to-Start	82	SL052B-17-Q	Inline Air Screwdriver, Angle Jaw	89
SA024C-26-Q	Inline Air Screwdriver, Push-to-Start	82	SL052B-25-Q	Inline Air Screwdriver, Angle Jaw	89
SA024C-8-Q	Inline Air Screwdriver, Push-to-Start	82	SL052B-8-Q	Inline Air Screwdriver, Angle Jaw	89
SA024C-9-Q	Inline Air Screwdriver, Push-to-Start	82	SL053B-10-Q	Inline Air Screwdriver, Lever Start	86
SA053B-10-Q	Inline Air Screwdriver, Push-to-Start	86	SL053B-17-Q	Inline Air Screwdriver, Lever Start	86
SA053B-17-Q	Inline Air Screwdriver, Push-to-Start	86	SL053B-25-Q	Inline Air Screwdriver, Lever Start	86
SA053B-25-Q	Inline Air Screwdriver, Push-to-Start	86	SL053B-8-Q	Inline Air Screwdriver, Lever Start	86
SA053B-8-Q	Inline Air Screwdriver, Push-to-Start	86	SQ024C-15-Q	Pistol Grip Air Screwdriver, Trigger + Push-to-Start	61
SA054C-10-Q	Inline Air Screwdriver, Push-to-Start	82	SQ024C-26-Q	Pistol Grip Air Screwdriver, Trigger + Push-to-Start	61
SA054C-17-Q	Inline Air Screwdriver, Push-to-Start	82	SQ024C-8-Q	Pistol Grip Air Screwdriver, Trigger + Push-to-Start	61
SA054C-8-Q	Inline Air Screwdriver, Push-to-Start	82			
SG021B-15-Q	Pistol Grip Air Screwdriver, Trigger Start	55, 74			
SG021B-26-Q	Pistol Grip Air Screwdriver, Trigger Start	55, 74			
SG021B-9-Q	Pistol Grip Air Screwdriver, Trigger Start	55, 74			
SG022B-15-Q	Pistol Grip Air Screwdriver, Trigger Start	69			
SG022B-26-Q	Pistol Grip Air Screwdriver, Trigger Start	55, 69			
SG022B-9-Q	Pistol Grip Air Screwdriver, Trigger Start	55, 69			

Index

Model Number	Description	Page
SQ024C-9-Q	Pistol Grip Air Screwdriver, Trigger + Push-to-Start	61
SQ054C-10-Q	Pistol Grip Air Screwdriver, Trigger + Push-to-Start	61
SQ054C-16-Q	Pistol Grip Air Screwdriver, Trigger + Push-to-Start	61
SQ054C-8-Q	Pistol Grip Air Screwdriver, Trigger + Push-to-Start	61
SR021B-10R-H	Angle Air Nutrunner, Lever Start	94, 107
SR021B-17R-H	Angle Air Nutrunner, Lever Start	94, 107
SR051B-11H-H	Angle Air Nutrunner, Lever Start	109
SR051B-16R-F	Angle Air Nutrunner, Lever Start	109
SR051B-16R-H	Angle Air Nutrunner, Lever Start	109
SR051B-24R-H	Angle Air Nutrunner, Lever Start	109
SR051B-6H-H	Angle Air Nutrunner, Lever Start	109
SR051B-8H-H	Angle Air Nutrunner, Lever Start	109
SR053B-11H-F	Angle Air Nutrunner, Lever Start	105
SR053B-11H-H	Angle Air Nutrunner, Lever Start	94, 105
SR053B-6H-H	Angle Air Nutrunner, Lever Start	94, 105
SR053B-8H-H	Angle Air Nutrunner, Lever Start	105
SRB21A-17-H	Angle Air Nutrunner, Lever Start w/ Push Button Reverse	107
SRB21A-17-P	Angle Air Nutrunner, Lever Start w/ Push Button Reverse	107
SRB51A-16-H	Angle Air Nutrunner, Lever Start w/ Push Button Reverse	109
SRB51A-16-P	Angle Air Nutrunner, Lever Start w/ Push Button Reverse	109

T

TR180S8	Rotary Transducer	52
TR20H4	Rotary Transducer	52
TR20S4	Rotary Transducer	52
TR250S12	Rotary Transducer	52
TR2H4	Rotary Transducer	52
TR500S12	Rotary Transducer	52
TR5H4	Rotary Transducer	52
TR75S6	Rotary Transducer	52
TS1000S12	Stationary Transducer	52
TS150S6	Stationary Transducer	52
TS300S8	Stationary Transducer	52
TS30S4	Stationary Transducer	52

Model Number	Description	Page
YED-200	Pistol Grip Pulse Tool, Trigger Start	125, 134
YETC-200ETB	Controller	136
YETC-200ETB-4	Controller	136
YETC-200ETF	Controller	136
YEX-120	Pistol Grip Pulse Tool, Trigger Start	125, 134
YEX-120A	Pistol Grip Pulse Tool, Trigger Start	134
YEX-120S	Inline Pulse Tool, Trigger Start	135
YEX-120SA	Inline Pulse Tool, Trigger Start	135
YEX-1400	Pistol Grip Pulse Tool, Trigger Start	125, 134
YEX-150	Pistol Grip Pulse Tool, Trigger Start	125, 134
YEX-150A	Pistol Grip Pulse Tool, Trigger Start	134
YEX-150S	Inline Pulse Tool, Trigger Start	135
YEX-150SA	Inline Pulse Tool, Trigger Start	135
YEX-1900	Pistol Grip Pulse Tool, Trigger Start	125, 134
YEX-3000	Pistol Grip Pulse Tool, Trigger Start	125, 134
YEX-300S	Inline Pulse Tool, Trigger Start	135
YEX-300SA	Inline Pulse Tool, Trigger Start	135
YEX-500S	Inline Pulse Tool, Trigger Start	135
YEX-500SA	Inline Pulse Tool, Trigger Start	135
YEX-501	Pistol Grip Pulse Tool, Trigger Start	125, 134
YEX-501A	Pistol Grip Pulse Tool, Trigger Start	134
YEX-700S	Inline Pulse Tool, Trigger Start	135
YEX-701	Pistol Grip Pulse Tool, Trigger Start	125, 134
YEX-901	Pistol Grip Pulse Tool, Trigger Start	125, 134

Y

Distributed by:



Ingersoll Rand Industrial Technologies provides products, services and solutions that enhance our customers' energy efficiency, productivity and operations. Our diverse and innovative products range from complete compressed air systems, tools and pumps to material and fluid handling systems and environmentally friendly microturbines. We also enhance productivity through solutions created by Club Car®, the global leader in golf and utility vehicles for businesses and individuals.

(800) 376-8665 • irtools.com